

PRODUCT SPECIFICATION

DATE:01/13/2013

cosmo ELECTRONICS CORPORATION	Photocoupler: KPS28010Z	No.61P05027	REV
		SHEET 1 OF 6	2

4 Pin SSOP Low Input Current Photocoupler

●Features

- 1.Halogen Free.
- 2.Pb free and RoHS compliant.
- 3.High isolation voltage(BV=3750Vrms).
- 4.Small and thin package(4pin SOP,Pin pitch 1.27mm).
5. Low input current type (IF=0.1mA).
- 6.Current transfer ratio
(CTR : 100~600% at IF=0.1mA Vce=5V)
- 7.High collector to emitter voltage(VCEO=80V).
- 8.High-speed switching tr=4μs(typ.),tf=3μs(typ.).
- 9.Agency Approvals
 - UL UL1577 / CUL C22.2 No.1 & NTC No.5
File No. E169586
 - VDE EN 60747
File No.40010469
 - FIMKO EN 60065 , EN 60950
File No.NCS/FI24585 A1
 - CQC GB4943 / GB8898-2011
File No.CQC10001049555 / CQC08001023986

●Applications

1. Programmable logic controllers.
2. Measuring instruments.
3. Power supply.
4. Hybrid IC.

PRODUCT SPECIFICATION

DATE:01/13/2013

cosmo ELECTRONICS CORPORATION	Photocoupler: KPS28010Z	No.61P05027	REV
		SHEET 2 OF 6	2

1. OUTSIDE DIMENSION : UNIT (mm)

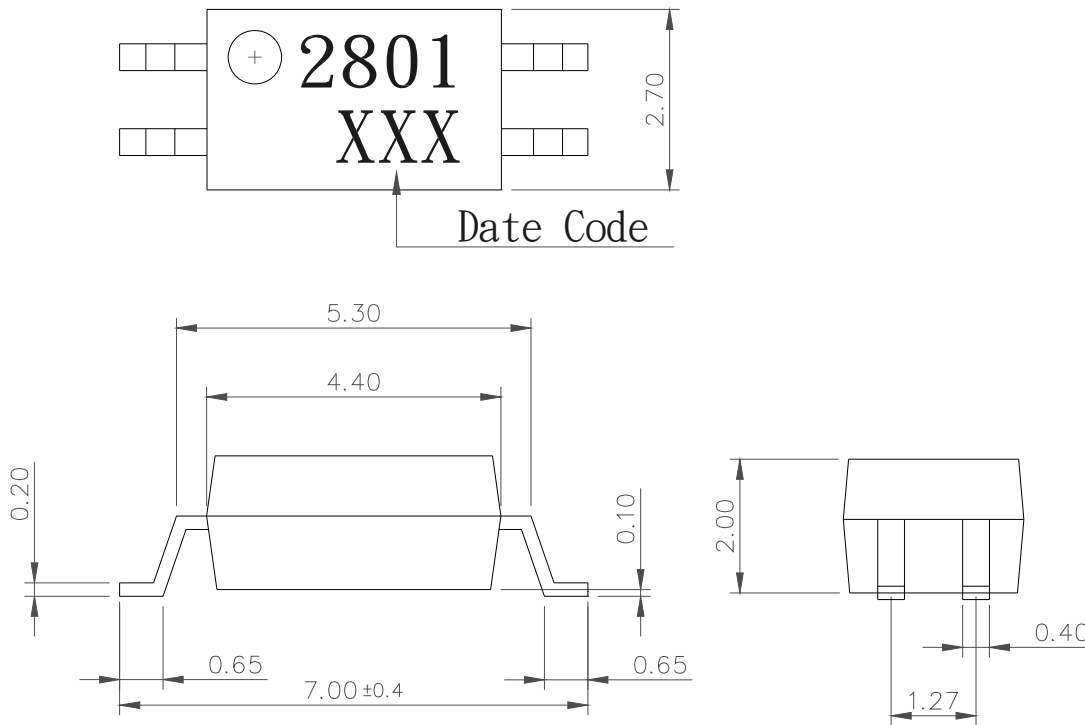

TOLERANCE : ±0.2mm

2. SCHEMATIC : TOP VIEW

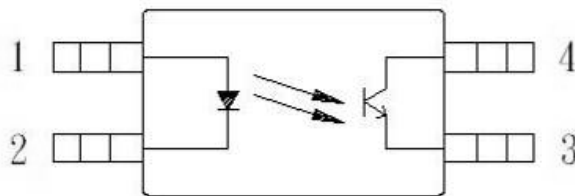

- 1. Anode
- 2. Cathode
- 3. Emitter
- 4. Collector

PRODUCT SPECIFICATION

DATE:01/13/2013

	Photocoupler: <h2>KPS28010Z</h2>	No.61P05027	REV
		SHEET 3 OF 6	2

●Absolute Maximum Ratings

Parameter	Symbol	Rating	Unit	
Input	Forward current	I_F	50	mA
	Peak forward current(*1)	I_{FP}	1	A
	Reverse voltage	V_R	6	V
	Power dissipation	P_D	60	mW
	Power dissipation derating	$P_D/^\circ C$	0.6	mW/°C
Output	Collector-emitter voltage	V_{CEO}	80	V
	Emitter-collector voltage	V_{ECO}	6	V
	Collector current	I_C	50	mA
	Collector power dissipation	P_C	160	mW
	Collector power dissipation derating	$P_C/^\circ C$	1.2	mW/°C
Isolation voltage 1 minute(*2)	V_{iso}	3750	Vrms	
Operating temperature	T_{opr}	-55 to +115	°C	
Storage temperature	T_{stg}	-55 to +125	°C	

*1 PW=100μs,Duty Cycle=1%.

*2 AC voltage for 1minute at T =25°C ,RH=60% between input and output.

●Electro-optical Characteristics

Ta=25°C

Parameter	Symbol	Conditions	MIN.	TYP.	MAX.	Unit
Input	Forward voltage	V_F IF=5mA	-	1.1	1.8	V
	Reverse current	I_R VR=5V	-	-	5	μA
	Terminal capacitance	C_t V=0, f=1MHz	-	60	-	pF
Output	Collector dark current	I_{CEO} VCE=50V,IF=0mA	-	-	100	nA
Transfer characteristics	Current transfer ratio(IC/IF)	CTR IF=0.1mA, VCE=5V	100	-	600	%
	Collector-emitter saturation	$V_{CE(sat)}$ IF=10mA, IC=2mA	-	0.1	0.2	V
	Isolation resistance	Riso DC500V	5×10^{10}	10^{11}	-	ohm
	Floating capacitance	C_f V=0, f=1MHz	-	0.4	-	pF
	Response time (Rise)(*3)	t_r Vce=5V, Ic=2mA, RL=100ohm	-	4	18	μs
Response time (Fall) (*3)	t_f	-	3	18	μs	

*3 Test circuit for switching time

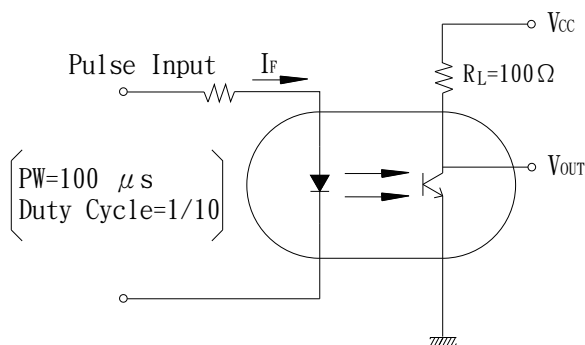

Classification table of current transfer ratio is shown below.

Model NO.	CTR(%)
KPS28010ZA	100 TO 600
KPS28010ZB	200 TO 500
KPS28010ZC	160 TO 400
KPS28010ZD	120 TO 300
KPS28010ZE	100 TO 200

PRODUCT SPECIFICATION

DATE:01/13/2013

cosmo ELECTRONICS CORPORATION	Photocoupler:	No.61P05027	REV
	KPS28010Z	SHEET 4 OF 6	2

Fig.1 Current Transfer Ratio vs. Forward Current

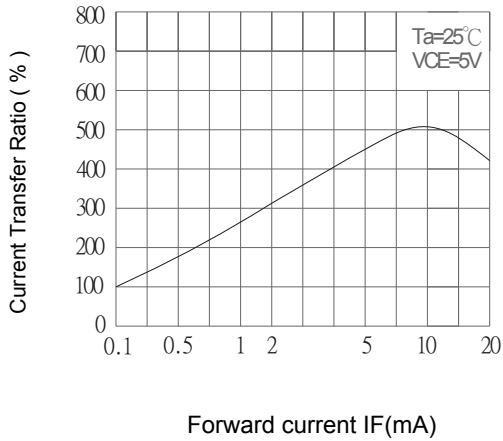

Fig.2 Collector Power Dissipation vs. Ambient Temperature

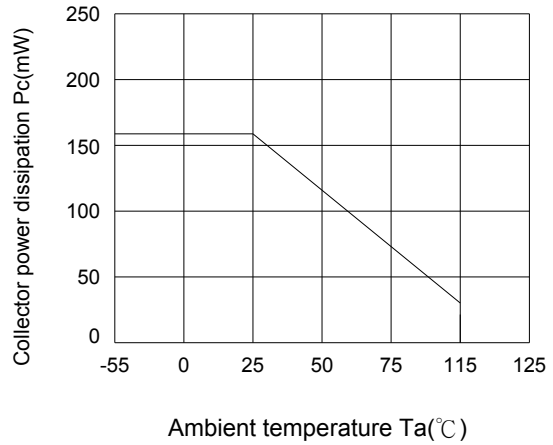

Fig.3 Collector Dark Current vs. Ambient Temperature

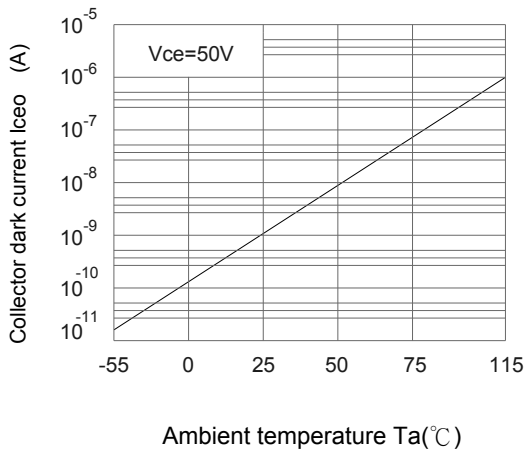

Fig.4 Forward Current vs. Ambient Temperature

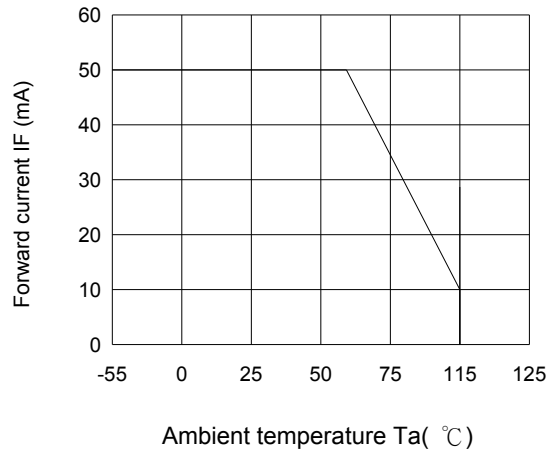

Fig.5 Forward Current vs. Forward Voltage

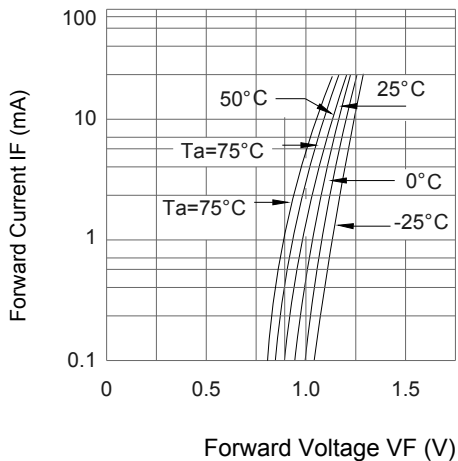
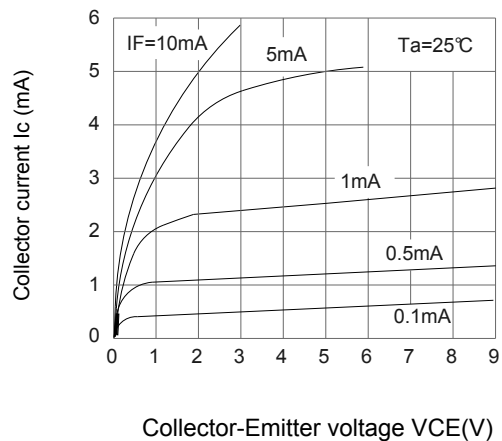

Fig.6 Collector Current vs. Collector-Emitter Voltage



PRODUCT SPECIFICATION

DATE:01/13/2013

cosmo ELECTRONICS CORPORATION	Photocoupler: KPS28010Z	No.61P05027	REV 2
		SHEET 5 OF 6	

Fig.7 Collector-Emitter Saturation Voltage vs. Ambient Temperature

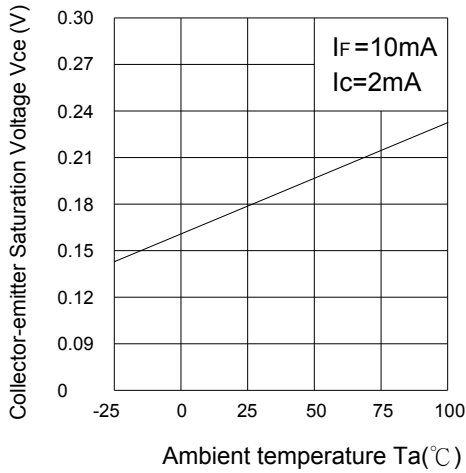

Fig.8 Collector-emitter Saturation Voltage vs. Forward Current

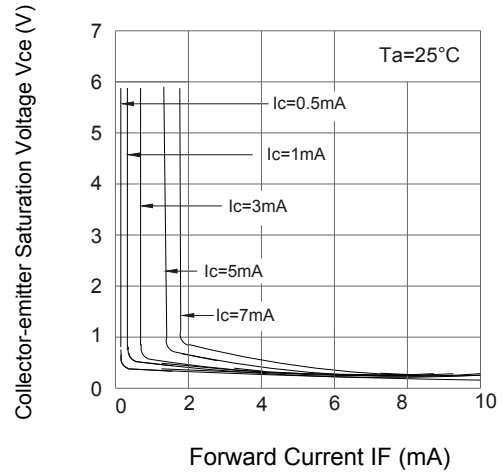

Fig.9 Response Time vs. Load Resistance

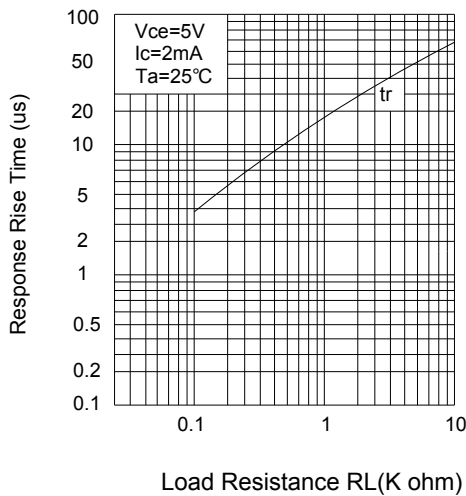

Fig.10 Response Time vs. Load Resistance

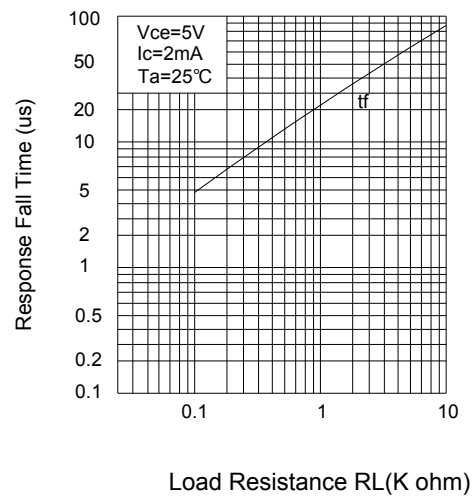
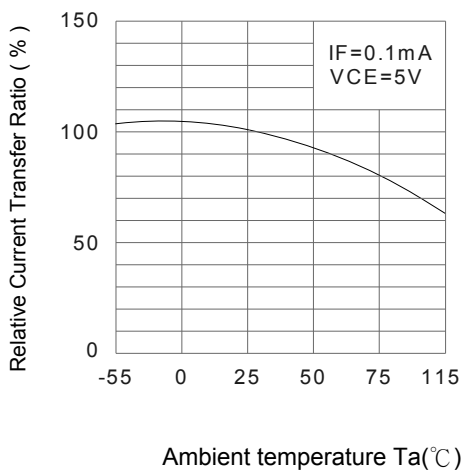

Fig.11 Relative Current Transfer Ratio vs. Ambient Temperature



PRODUCT SPECIFICATION

DATE:01/13/2013

cosmo ELECTRONICS CORPORATION	Photocoupler: KPS28010Z	No.61P05027	REV
		SHEET 6 OF 6	2

NOTICE

The information contained in this document is a general product description and is subject to change without notice. Please contact cosmo in order to obtain the latest device data sheets before using any cosmo device. cosmo does not assume any responsibility for use of any circuitry described. No circuit patent licenses are implied. This publication is the property of cosmo. No part of this publication may be reproduced or copied in any form or by any means, or transferred to any third party without the prior written consent of cosmo Electronics Corporation.

The devices listed in this document are designed for general applications only in electronic equipment. No devices shall be deployed which require higher level of reliability such as:

- Medical and other life support equipments.
- Space application.
- Telecommunication equipment (trunk lines).
- Nuclear power control equipment.

Unless it received prior written approval from cosmo. cosmo takes no responsibility for damages arise form the improper usage of our device. Please contact cosmo for further information regarding the above notices.