

VOICE RECORDING & REPRODUCING LSI

KS5911 is a CMOS LSI for voice (sound) recording & reproducing LSI using the ADM (Adaptive Delta Modulation) algorithm.

KS5911 can be used in two kinds of modes, that is, manual mode and auto mode, according to the way of recording reproducing.

It can be used 64K or 256K DRAM, up to 4 pcs.

In the manual mode, using a 4-input pin, a maximum of 16 sound phrases can be performed and the start/stop input is activated by an external key.

In the auto mode, the input voice signal is automatically recorded and recording stops with silence detection. The recorded voice signal is reproduced automatically.

KS5911 can be used with 4 kinds of (8K, 11K, 16K, 32K BPS).

48 FQP

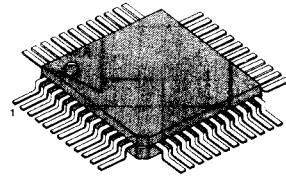

2

FEATURES

- Voice recording & reproducing LSI using ADM algorithm.
- Auto-talking back function with auto mode.
- 64K DRAM or 256K DRAM can be used selectively from 1 ~ 4 pcs
- Capable of recording & reproducing up to 16 phrases.
- Selective 4 kinds of bits rate (8K, 11K, 16K, 32K bps).
- Built-in in DRAM refresh circuit.
- Built-in microphone amplifier.
- Built-in 10-bit D/A converter.
- Built-in voltage follower for D/A converter buffering.
- Built-in RC oscillator (640 KHz-1 MHz).
- +5V single power.
- Clocked CMOS for low power consumption.
- 48 pin FQP package.
- For long time recording/reproducing without phrase selection, memory extension is possible by using the EXT/RIPPLE pin.

FUNCTIONAL BLOCK DIAGRAM

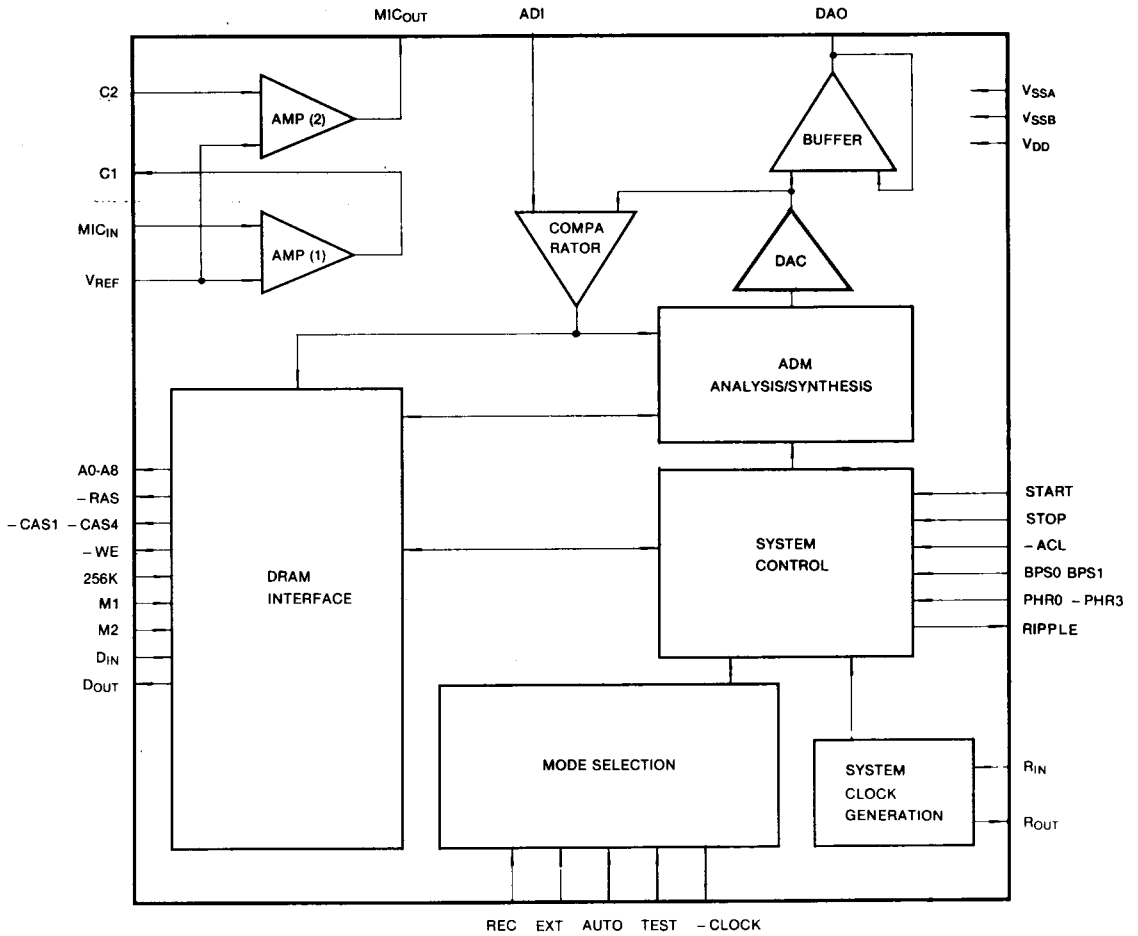

Figure 1. KS5911 Functional Block Diagram

PIN DESCRIPTION

Pin Name	Pin No.	I/O	Pull Up/Down	Function																													
ACL	1	I	UP	Reset Input Pin. Use CAP. (1μF)																													
REC	2	I	DOWN	At manual mode. H; Recording mode L; Reproducing mode.																													
M1	3	I	—	Programming terminal for the number of outer DRAMs.																													
M2	4	I	—																														
<table border="1"> <thead> <tr> <th>No.</th> <th>Pin</th> <th>M2</th> <th>M1</th> <th>No.</th> <th>Pin</th> <th>M2</th> <th>M1</th> </tr> </thead> <tbody> <tr> <td>1pcs</td> <td></td> <td>L</td> <td>L</td> <td>3pcs</td> <td></td> <td>H</td> <td>L</td> </tr> <tr> <td>2pcs</td> <td></td> <td>L</td> <td>H</td> <td>4pcs</td> <td></td> <td>H</td> <td>H</td> </tr> </tbody> </table>					No.	Pin	M2	M1	No.	Pin	M2	M1	1pcs		L	L	3pcs		H	L	2pcs		L	H	4pcs		H	H					
No.	Pin	M2	M1	No.	Pin	M2	M1																										
1pcs		L	L	3pcs		H	L																										
2pcs		L	H	4pcs		H	H																										
	7			N.C.																													
PHR0	5	I	DOWN	Programming terminal for the phrase selection.																													
PHR1	6	I	DOWN																														
PHR2	8	I	DOWN																														
PHR3	9	I	DOWN																														
<table border="1"> <thead> <tr> <th>Phrase No.</th> <th>PHR0</th> <th>PHR1</th> <th>PHR2</th> <th>PHR3</th> </tr> </thead> <tbody> <tr> <td>0</td> <td>L</td> <td>L</td> <td>L</td> <td>L</td> </tr> <tr> <td>1</td> <td>L</td> <td>L</td> <td>L</td> <td>H</td> </tr> <tr> <td>.</td> <td>.</td> <td>.</td> <td>.</td> <td>.</td> </tr> <tr> <td>.</td> <td>.</td> <td>.</td> <td>.</td> <td>.</td> </tr> <tr> <td>15</td> <td>H</td> <td>H</td> <td>H</td> <td>H</td> </tr> </tbody> </table>					Phrase No.	PHR0	PHR1	PHR2	PHR3	0	L	L	L	L	1	L	L	L	H	15	H	H	H
Phrase No.	PHR0	PHR1	PHR2	PHR3																													
0	L	L	L	L																													
1	L	L	L	H																													
.																													
.																													
15	H	H	H	H																													
BPS0	10	I	DOWN	Programming terminal for bit rate selection.																													
BPS1	11	I	DOWN																														
<table border="1"> <thead> <tr> <th>Bit Rate</th> <th>BPS1</th> <th>BPS0</th> <th>Bit Rate</th> <th>BPS1</th> <th>BPS0</th> </tr> </thead> <tbody> <tr> <td>8KBits/sec</td> <td>L</td> <td>L</td> <td>16KBits/sec</td> <td>H</td> <td>L</td> </tr> <tr> <td>11KBits/sec</td> <td>L</td> <td>H</td> <td>32KBits/sec</td> <td>H</td> <td>H</td> </tr> </tbody> </table>				Bit Rate	BPS1	BPS0	Bit Rate	BPS1	BPS0	8KBits/sec	L	L	16KBits/sec	H	L	11KBits/sec	L	H	32KBits/sec	H	H												
Bit Rate	BPS1	BPS0	Bit Rate	BPS1	BPS0																												
8KBits/sec	L	L	16KBits/sec	H	L																												
11KBits/sec	L	H	32KBits/sec	H	H																												
D _{IN}	12	I	UP	Data input pin. Connect this pin to data output pins of DRAMs.																													
RIPPLE	13	O	—	At EXT = H, when maximum address overflow occurs, this pin generates a ripple clock.																													
CAS1	14	O	—	Column address strobe output. Used from CAS1 to that required corresponding to the number of external DRAMs.																													
CAS2	15	O	—																														
CAS3	16	O	—																														
CAS4	17	O	—																														

(to be continued)

2

PIN DESCRIPTION (Continued)

Pin Name	Pin No.	I/O	Pull Up/Down	Function
CLOCK	18	O	—	Only test.
D _{OUT}	19	O	—	Data output pin. Connect this to data input pins of external DRAMs.
A8	20	O	—	Address output pin to DRAMs. A8 is not needed when 64K bit DRAMs are used.
A7	21	O	—	
A6	22	O	—	
A5	23	O	—	
A4	24	O	—	
A3	25	O	—	
A2	26	O	—	
A1	27	O	—	
A0	28	O	—	
V _{DD}	29	Power	—	+5V (Typ.)
ADI	30	I	—	Voice (or Signal) input pin. The center of input signal level must be 1/2 V _{DD} .
DAO	31	O	—	Synthesized voice output pin. The center of output level is 1/2 V _{DD} .
V _{SSB}	32	Power	—	System ground.
MIC _{OUT}	33	O	—	Output pin of built-in AMP (1). The center of output level is 1/2 V _{DD} .
C2	34	I	—	Input pin of built-in AMP (2).
C1	35	O	—	Output pin of built-in AMP (2). The center of output level is 1/2 V _{DD} .
MIC _{IN}	36	I	—	Input pin of built-in AMP (1). Connect to microphone through capacitor.
V _{REF}	37	I/O	—	For connecting capacitor which stabilized the reference voltage for the built-in AMP.
V _{SSA}	38	Power	—	Analog ground
STOP	39	I	DOWN	Manual stop input pin.
TEST	40	I	DOWN	Only test.
START	41	I	DOWN	Manual start input pin.
EXT	42	I	—	At EXT = H: When address overflow occurs, RIPPLE pin generates a ripple clock. At EXT = L: KS5911 is manual mode.
AUTO	43	I	DOWN	Auto Talking-back Mode
WE	44	O	—	Connect to external D-RAM

PIN DESCRIPTION (Continued)

Pin Name	Pin No.	I/O	Pull Up/Down	Function
RAS	45	O	—	Row address strobe output. Connect this to RAS pins of outer DRAMs.
256K	46	I	—	Input for the selection of the types of external DRAMs. 256K = H: 256K DRAM type. 256K = L: 64K DRAM type.
R _{OUT}	47	O	—	Pins for RC oscillator Attach variable resistor between R _{OUT} and R _{IN} Generating clock frequency: 640KHz-1MHz.
R _{IN}	48	I	—	

Table 1. KS5911 pin description

'L' = V_{SSB}
'H' = V_{DD}

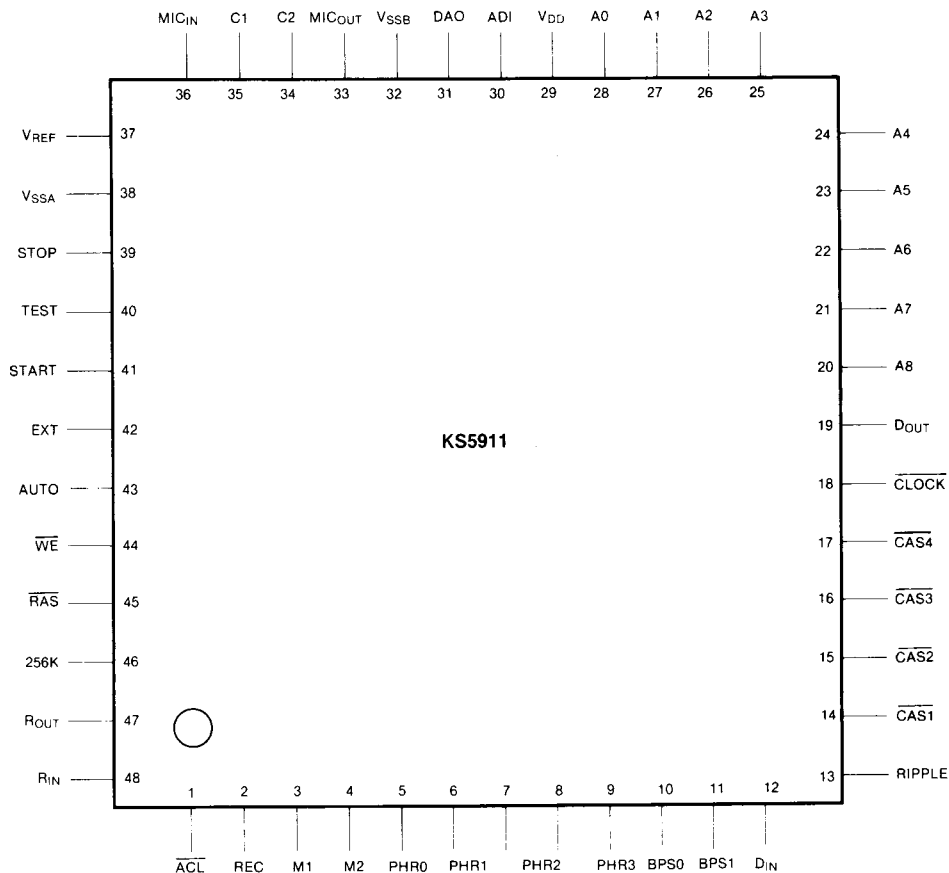

Figure 2. KS5911 pin configuration (48 FQP, Top view)

FUNCTIONAL DESCRIPTION

Manual Mode (EXT = 'L', TEST = 'L')

Phrase Selection

Using the 4 input terminals of PHR0 – PHR3, the sound recording/reproducing of a maximum of 16 phrases can be performed.

Before starting the sound recording/reproducing, phrases must be specified and can be selected at random.

Phrase No.	Pin	PHR0	PHR1	PHR2	PHR3
No. 0		L	L	L	L
No. 1		L	L	L	H
.					
.					
.					
No. 14		H	H	H	L
No. 15		H	H	H	H

Table 2. Selection of phrases

Selection of bit rate

KS5911 can use 4 kinds (8K, 11K, 16K, 32K) of bits rate as shown in Table 3, which are selected by BPS0 and BPS1. Since the bit rate is independently specified for sound recording/reproducing, it is possible to change the reproduced voice slow/fast to speak.

Bit Rate	Pin	BPS1	BPS0	Using time (64K)	Using time (256K)
8K bps		L	L	about 8 sec.	about 32 sec.
11K bps		L	H	about 6 sec.	about 24 sec.
16K bps		H	L	about 4 sec.	about 16 sec.
32K bps		H	H	about 2 sec.	about 8 sec.

*When $f_x = 640$ KHz.

*Initial 1K bits is used as index area.

Table 3. Selection of bit rate

Recording procedure

- (1) Before recording, the KS5911 must be reset by the \overline{ACL} pin.
- (2) The REC pin must be on H state.
- (3) Select bit-rate, phrase number.
- (4) When START pin is activated, the contents of the address counter are added successively and recording is started.
- (5) Then STOP pin is activated or the contents of address counter are reached the maximum address of memory, the recording is stopped.
- (6) Repeat from 2), then another phrase is recorded.
- (7) Changes of bit-rate and phrase number during recording are ignored.

Reproducing procedure

- (1) REC pin must be set to L.
- (2) Select bit-rate and phrase number.
- (3) If START pin is activated, the start and stop address are read from the index area of memory and reproduced from start address to stop address.
- (4) If current address is equal to stop address, reproducing is stopped.
- (5) Repeat from 2), then another phrase are reproduced.
- (6) Changes of bit-rate and phrase number during reproducing are ignored.

Auto mode

- If AUTO pin is set to "H", the KS5911 is in auto-talk back mode.
- Auto mode is independent of REC pin state.
- In the auto mode, KS5911 is automatically in recording mode and an internal system reset signal is created. Therefore, recording is started.
- In the auto mode, sound information is accumulated on the DRAM like in manual operation mode.
- When sound stops, namely, silence is detected internally, KS5911 automatically stops recording and reproduces the sound stored in the memory.
- If the ADI input signal swings within $2.5 \pm 0.3125V$ about 0.5sec the KS5911 set to the reproducing mode automatically.

Reset function**The status during reset operation**

Low level to the ACL pin causes the reset to the KS5911 and almost internal operations such as recording/reproducing stop, but the refresh counter doesn't stop, so the data stored in DRAM are protected.

The status after reset operation

- Internal address counter is preset to 00400 (H).
- In the recording mode, if recorded address reaches the maximum address, start input is not given in order to protect DRAM data. The function of RAM-data protection is released by the reset so that the KS5911 can record newly.

Precautions

- During recording/reproducing operation the pins of M1, M2 and 256K must not be changed.
- System reset doesn't stop the oscillation in order to preserve the data in the DRAMs.
- The conditions of phrase, bit-rate and recording/reproducing modes settled before the start signal is inputted to the KS5911 and in the middle of recording/reproducing, conditions of phrase or bit rate must not be changed.
- During recording, start input is not accepted.
- The resistor for the RC oscillator must be attached closest to the R_{IN} , R_{OUT} pin.
- The output clock (fx) from R_{OUT} is 640 KHz.
If the resistor value is small, the frequency is high and if the resistor value is large the frequency is low.
- If the frequency (fx) is high, output voice quality is good because of a high bit rate, but if the frequency is low, output voice quality is bad because of a low bit rate.
- In the recording mode, a built-in mute circuit operates in order to protect against the howling effect.

Auto Mode

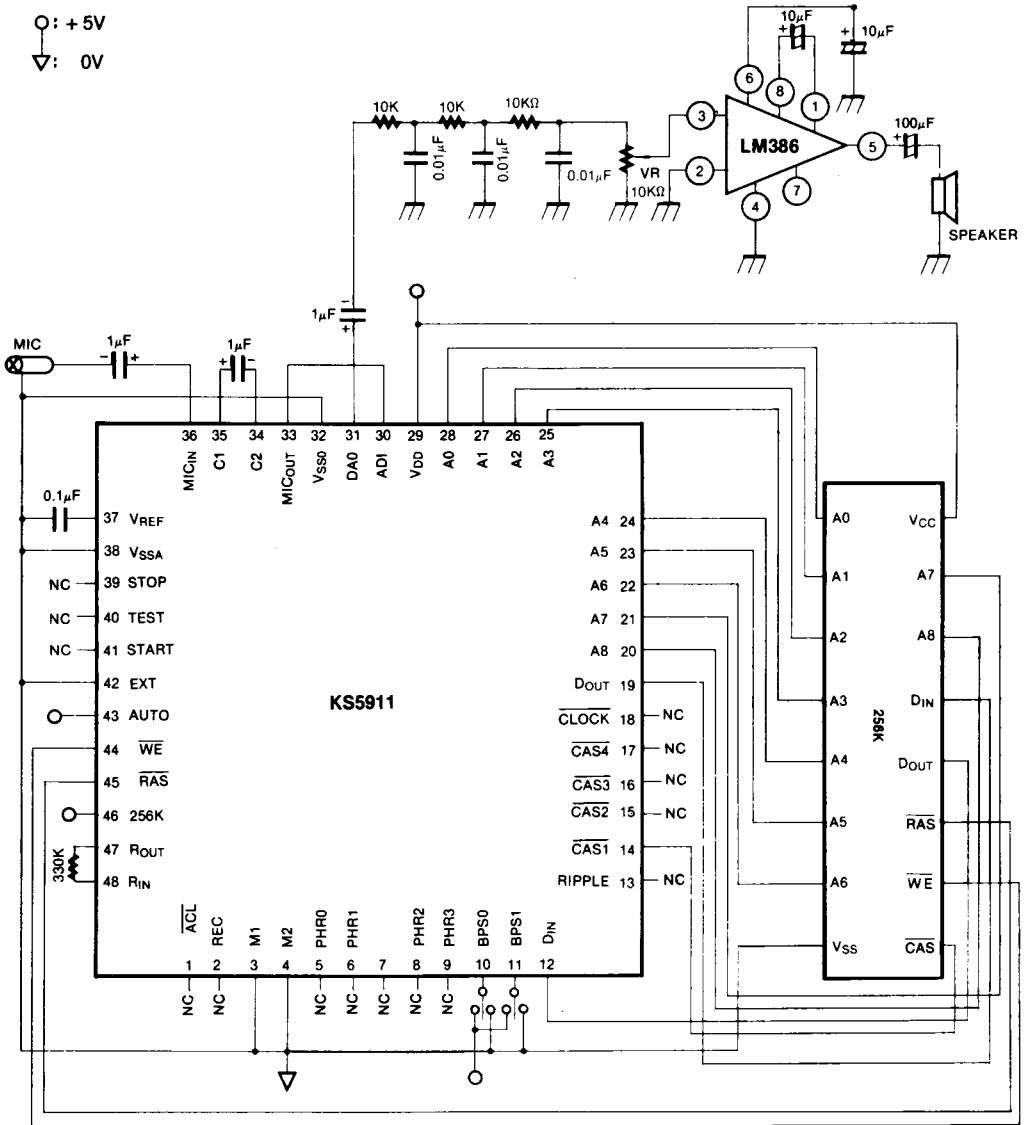

*The type of memory used can be 64K DRAM or 256K DRAM up to a maximum of 4 pcs.
Figure 4. Application circuit is in the auto mode

APPLICATION CIRCUIT

Manual Operation Mode: Auto Mode

Auto Mode

○ : +5V

▽ : 0V

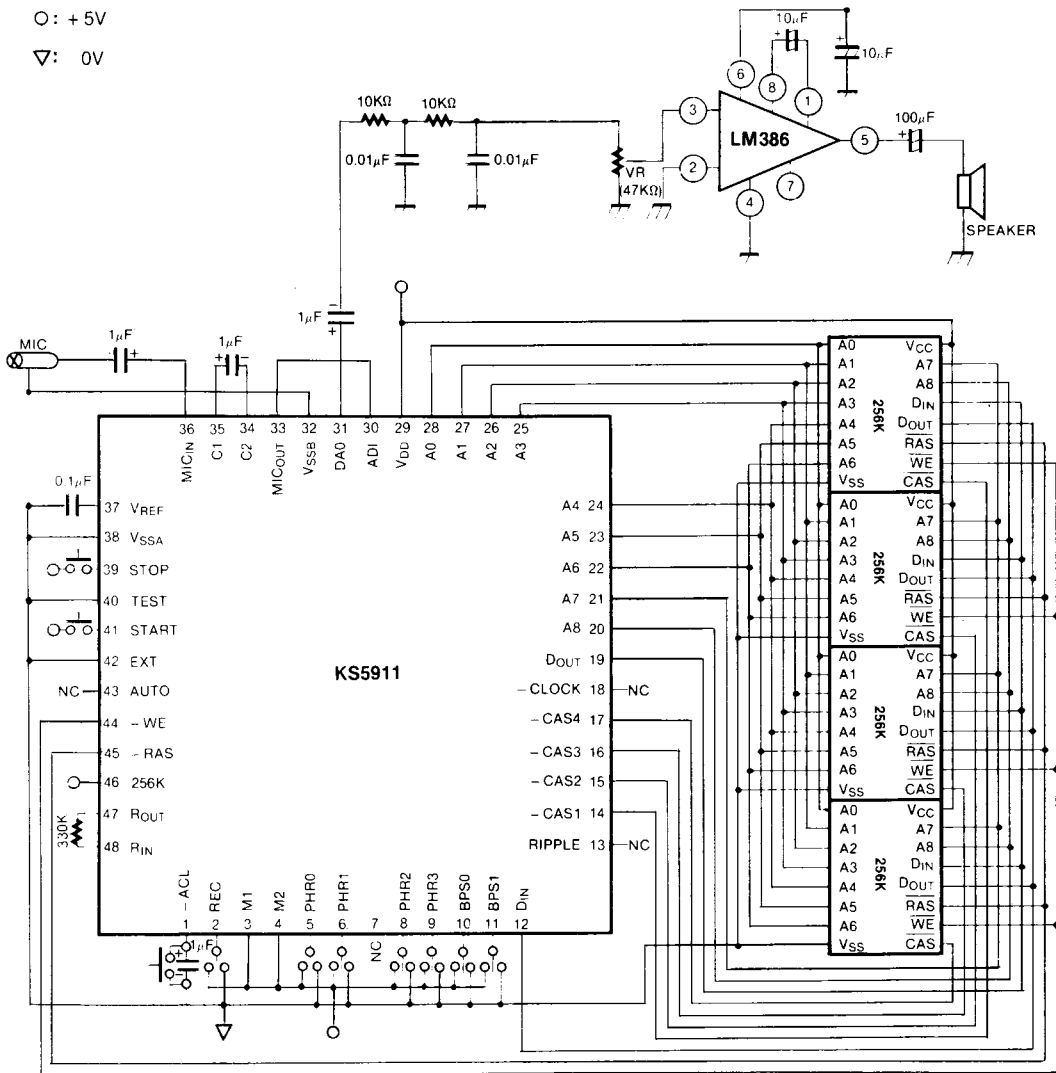

2

*In this diagram, if AUTO (N.C.) set to H, the KS5911 is in auto-mode.
Figure 3. Application circuit is in the manual operation mode

LED DRIVER

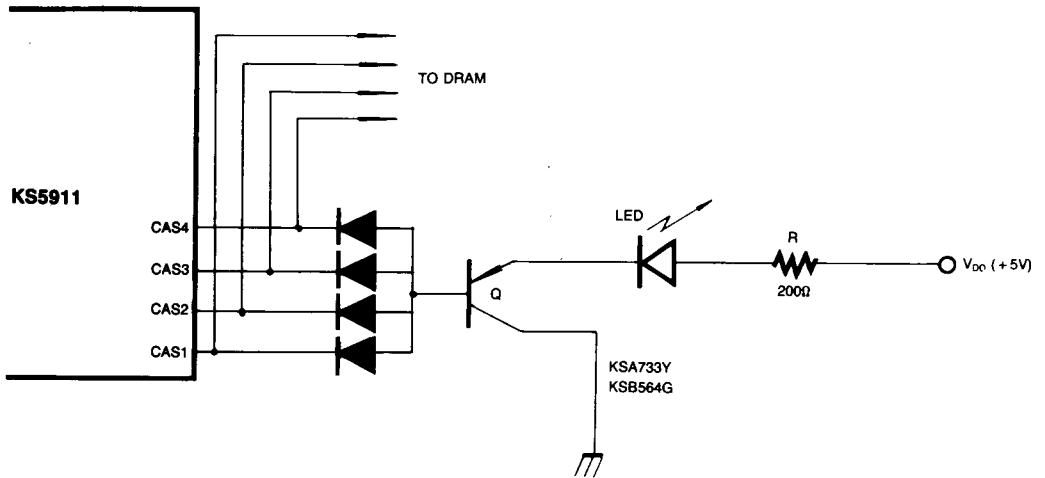

*Note: When recording or reproducing, the LED is turned on.

ELECTRICAL CHARACTERISTICS

Absolute Maximum Ratings

Description	Symbol	Specifications	Unit
Power Supply	V_{DD}	-0.3 ~ 6.0	V
Input Voltage	V_{IN}	-0.3 ~ V_{DD} + 0.3	V
Storage Temperature	T_{ST}	-30 ~ 90	C

Table 4. Absolute maximum ratings

2

Recommended Operation Conditions

Description	Symbol	Specifications	Unit
Power Supply	V_{DD}	4.5 ~ 5.5	V
Input Voltage	V_{IN}	0 ~ V_{DD}	V
Operating Temperature	T_{OP}	-10 ~ 50	°C
Oscillation Frequency	F_x (fx)	640 ~ 1000	KHz

Table 5. Recommended operation conditions

DC Characteristics ($V_{DD} = 5V$, $T_a = 25^\circ C$, $f_x = 640$ KHz)

Description	Symbol	Specific Pin	Condition	Min	Typ	Max	Unit
'H' Input Current	I_{IH}	REC, STOP, START AUTO, TEST, BPS0 BPS1, PHR0—PHR3	$V_{IN} = V_{DD}$		12	18	μA
'L' Input Current 1	I_{IL1}	D_{IN}	$V_{IN} = V_{SSB}$		90	150	μA
'L' Input Current 2	I_{IL2}	ACL	$V_{IN} = V_{SSB}$		800	1100	μA
'H' Input Voltage 1	V_{IH1}	EXT, D_{IN}	—	3			V
'H' Input Voltage 2	V_{IH2}	All input pin except EXT, D_{IN}	—	4.3			V
'L' Input Voltage 1	V_{IL1}	EXT, D_{IN}	—			0.5	V
'L' Input Voltage 2	V_{IL2}	All input pin except EXT, D_{IN}	—			0.3	V
'H' Output Current	I_{OH}	Output pin	$V_{OUT} = 2.4V$	1.5	3.3		mA
'L' Output Current	I_{OL}	Output pin	$V_{OUT} = 0.8V$	1.0	2.2		mA
Stand-by Current	I_{SS}	V_{SSA}	<ul style="list-style-type: none"> •Without the external loads at all out pins. •No signal is input 		1	1.5	mA

Table 6. DC characteristics

AC CHARACTERISTICS

When Recording

Description	Symbol	Min	Typ	Max	Unit
Low Address Set-up Time	T_{ASR}	150	—	—	ns
Low Address Holding Time	T_{RAH}	—	—	—	
\overline{RAS} Pulse Width	T_{RAS}	—	4.58	—	μS
Column Address Set-up Time	T_{ASC}	150	—	—	ns
Column Address Holding Time	T_{CAH}	500	—	—	
\overline{CAS} Pulse Width	T_{CAS}	—	3.05	—	μS
\overline{WE} Pulse Width	T_{WEP}	—	3.05	—	μS
Data Output Set-up Time	T_{DWS}	500	—	—	ns
Data Output Holding Time	T_{DWH}	500	—	—	

Table 7. AC characteristics (1)

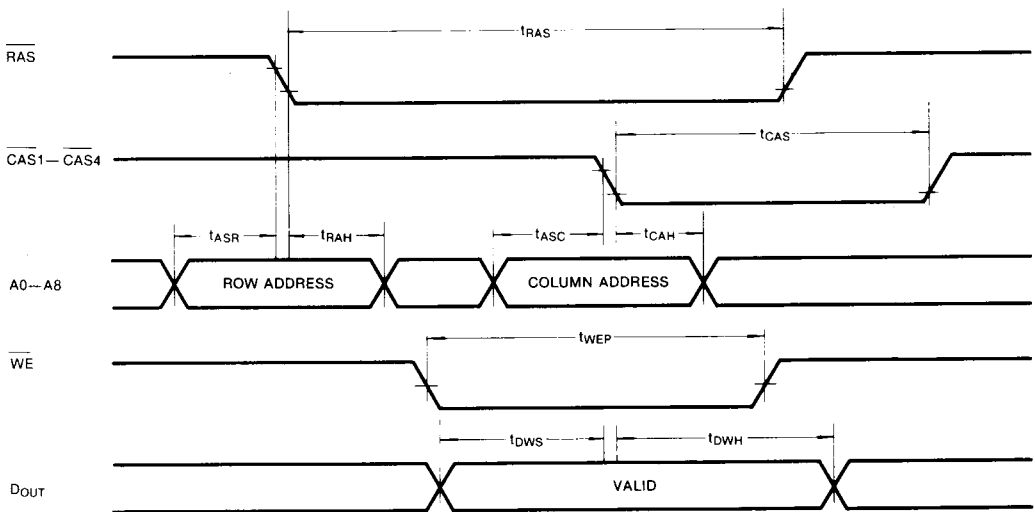

Figure 8. AC Timing Diagrams (1)

When Reproducing

Description	Symbol	Min	Typ	Max	Unit
Data Input Set-up Time	t_{DCS}	500	—	—	ns
Data Input Holding Time	t_{DCH}	0	—	—	

2

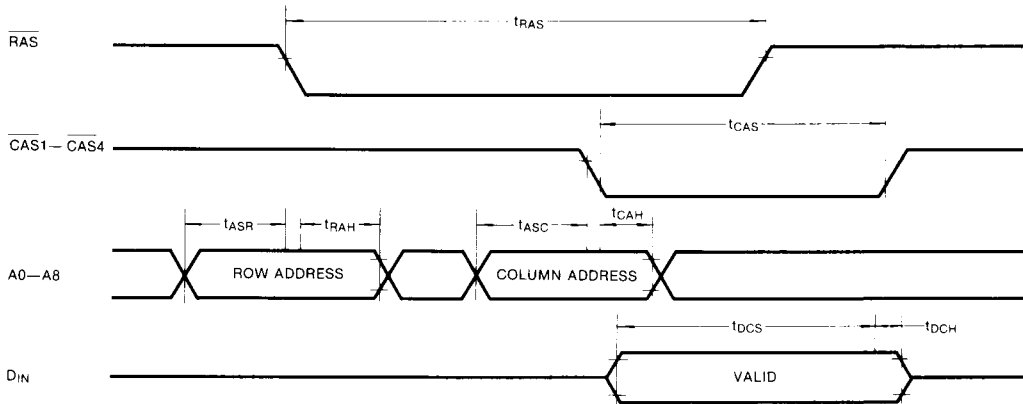

Figure 7. AC Timing Diagrams (2)

Analog Characteristics

Description	Symbol	Specific Pin	Condition	Min	Typ	Max	Unit
Input Voltage Range	V_{IN1}	MIC_{IN}	AMP (1) + AMP (2)			12.5	mV_{P-P}
	V_{IN2}	MIC_{IN}	AMP (1)			125	
	V_{IN3}	C2	AMP (2)			250	
Voltage Gain	V_{G1}	$MIC_{IN}-MIC_{OUT}$	$V_{IN} = 6mV_{P-P}$ $f_{in} = 100\text{ Hz} - 10\text{ KHz}$		46		db
	V_{G2}	$MIC_{IN}-C1$			26		
	V_{G3}	C2- MIC_{OUT}			20		
Output Resistance	R_{OUT1}	C1	—		1.2		$K\Omega$
	R_{OUT2}	MIC_{OUT}			1.2		
Input Voltage Range	V_{IN4}	ADI	—	1.25		3.75	V
Output Resistance	R_{OUT3}	DAO	—		0.9		$K\Omega$

Table 9. Analog characteristics