

PRODUCT SPECIFICATION

DATE: 05/27/11'

cosmo ELECTRONICS CORPORATION	SOLID STATE RELAY :	NO. 58032205	REV.
	KSD205AC3	SHEET 1 OF 2	5

1. OUTSIDE DIMENSION : UNIT (mm)

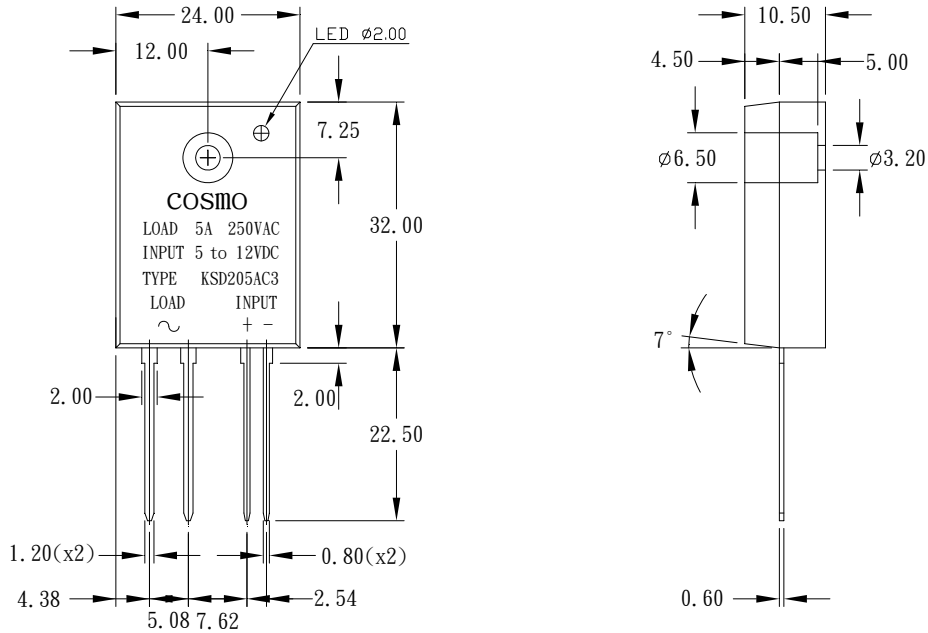

2. SCHEMATIC : TOP VIEW

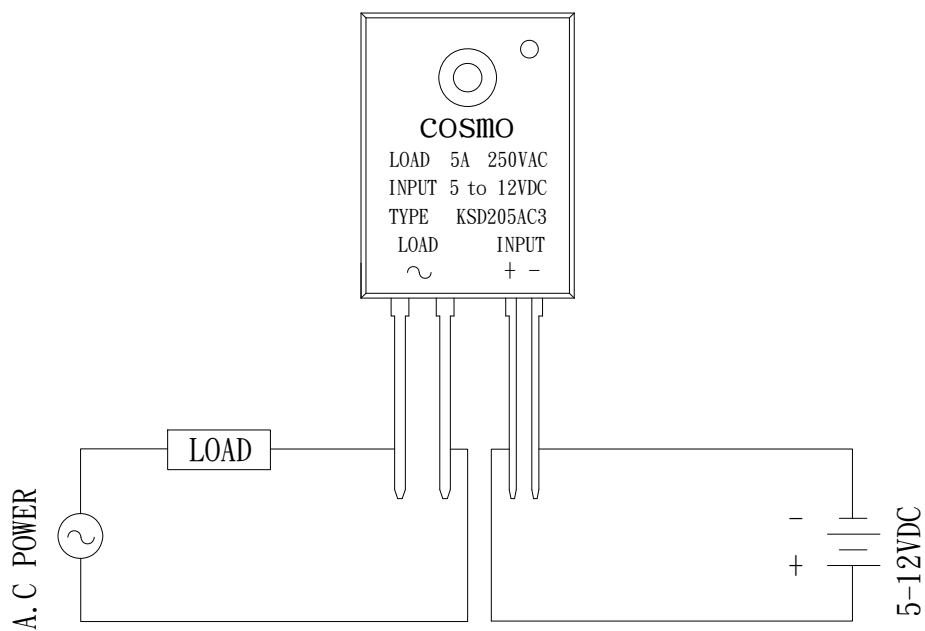

PRODUCT SPECIFICATION

DATE: 05/27/11'

cosmo ELECTRONICS CORPORATION	SOLID STATE RELAY :	NO. 58032205	REV.
	KSD205AC3	SHEET 2 OF 2	5

3. Absolute Maximum Ratings

(Ta=25°C)

Parameter		Symbol	Rating	Unit
Input	Input signal voltage	V_{IN}	5-12	VDC
	Drop-out voltage	V_{do}	1	VDC
Output	RMS on-state current	I_T	5	Arms
	Peak one cycle surge current	I_{surge}	50	A
	Repetitive peak-off state voltage	V_{DRM}	600	V
	Operating frequency	f	47~70	Hz
	Critical rate of rise of on-state current	di/dt	50	A/us
	Load supply voltage	V_{out}	250	Vrms AC
Isolation voltage input to output		V_{iso}	4000	Vrms
Operating temperature		T_{opr}	-30~100	°C
Storage temperature		T_{stg}	-30~125	°C
Soldering temperature 10 sec		T_{sol}	260	°C

4. Electrical Characteristics

(Ta=25°C)

Parameter		Symbol	Conditions	MIN	TYP	MAX	Unit
Input	Pick-up voltage	V_{pu}	$I_t=1Arms$			4	VDC
	Input current	I_{in}	$V_{in}=5\sim 12V$	5		35	mA
Output	On-state voltage	V_T	$I_T=1Arms$			1.5	Vrms
	Operating current	I_{op}	$V_{out}=240vrms$	50			mArms
	Leakage current	I_{leak}	$V_{out}=240vrms$			7	mArms
	Critical rate of rise of off-state voltage	dv/dt		50	200		V/us
	Zero-cross voltage	V_{ox}			YES		
	Load Voltage Rating	V_{out}	$I_T=50mArms$ MIN	50		280	VAC
Minimum trigger current		I_{FT}	$V_{DRM}=600V$			10	mA
Isolation resistance input to output		R_{ISO}	DC500V	10			GΩ
Turn-on time		T_{on}	60Hz AC			8.3	mS
Turn-off time		T_{off}	60Hz AC			8.3	mS
Thermal resistance (between junction and case)		R_{th} (j-c)			1.3		°C/W