

# KSH5027F

**SemiHow**  
Know-How for Semiconductor

# KSH5027F

## High Voltage and High Reliability

- High Speed Switching
- Wide SOA

3 Amperes  
NPN Silicon Power Transistor  
50 Watts

## Absolute Maximum Ratings $T_C=25^{\circ}\text{C}$ unless otherwise noted

CHARACTERISTICS	SYMBOL	RATING	UNIT
Collector-Base Voltage	$V_{CBO}$	1100	V
Collector-Emitter Voltage	$V_{CEO}$	800	V
Emitter-Base Voltage	$V_{EBO}$	7	V
Collector Current(DC)	$I_C$	3	A
Collector Current(Pulse)	$I_{CP}$	10	A
Base Current	$I_B$	1.5	A
Collector Dissipation( $T_C=25^{\circ}\text{C}$ )	$P_C$	40	W
Junction Temperature	$T_J$	150	$^{\circ}\text{C}$
Storage Temperature	$T_{STG}$	-55~150	$^{\circ}\text{C}$

TO-220F  
1. Base  
2. Collector  
3. Emitter

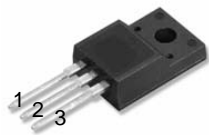

## Electrical Characteristics $T_C=25^{\circ}\text{C}$ unless otherwise noted

CHARACTERISTICS	SYMBOL	Test Condition	Min	Typ.	Max	Unit
Collector-Base Breakdown Voltage	$V_{CBO}$	$I_C=1\text{mA}, I_E=0$	1100			V
Collector-Emitter Breakdown Voltage	$V_{CEO}$	$I_C=5\text{mA}, I_B=0$	800			V
Emitter-Base Breakdown Voltage	$V_{EBO}$	$I_E=1\text{mA}, I_C=0$	7			V
Collector-Emitter Sustaining Voltage	$I_{CEX(sus)}$	$I_C=1.5\text{A}, I_{B1}=-I_{B2}=0.3\text{A}$ $L=2\text{mH}, \text{Clamped}$	800			V
Collector Cutoff Current	$I_{CBO}$	$V_{CB}=800\text{V}, I_E=0$			10	$\mu\text{A}$
Emitter Cutoff Current	$I_{EBO}$	$V_{EB}=5\text{V}, I_C=0$			10	$\mu\text{A}$
DC Current Gain	$h_{FE1}$ $h_{FE2}$	$V_{CE}=5\text{V}, I_C=0.2\text{A}$ $V_{CE}=5\text{V}, I_C=1\text{A}$	10 8		40	
Collector-Emitter Saturation Voltage	$V_{CE(sat)}$	$I_C=1.5\text{A}, I_B=0.3\text{A}$			2	V
Base-Emitter Saturation Voltage	$V_{BE(sat)}$	$I_C=1.5\text{A}, I_B=0.3\text{A}$			1.5	V
Output Capacitance	$C_{ob}$	$V_{CB}=10\text{V}, I_E=0, f=0.1\text{MHz}$		60		pF
Current Gain Bandwidth Product	$f_T$	$V_{CE}=10\text{V}, I_C=0.2\text{A}$		15		MHz
Turn on Time	$t_{on}$	$V_{CC}=400\text{V}, I_C=5\text{A}$ $I_{B1}=-2.5\text{A}, I_{B2}=2\text{A}$ $R_L=200\Omega$			0.5	$\mu\text{s}$
Storage Time	$t_{stg}$				3.0	$\mu\text{s}$
Fall Time	$t_f$				0.3	$\mu\text{s}$

Note :  $h_{FE1}$  Classification R : 15 ~ 30, O : 20 ~ 40

# Typical Characteristics

Figure 1. Static Characteristic

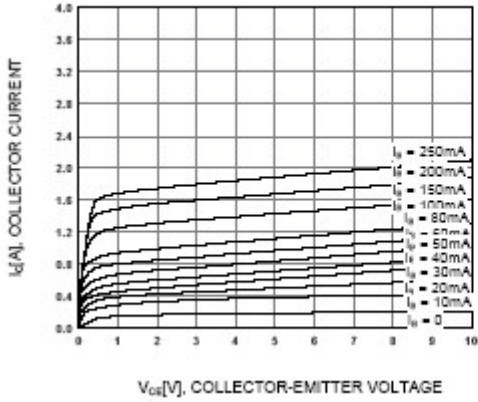

Figure 2. DC current Gain

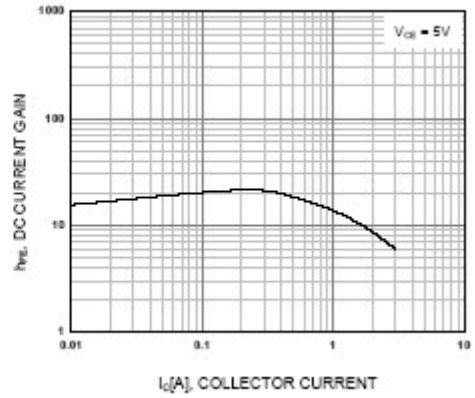

Figure 3. Base-Emitter Saturation Voltage  
Collector-Emitter Saturation

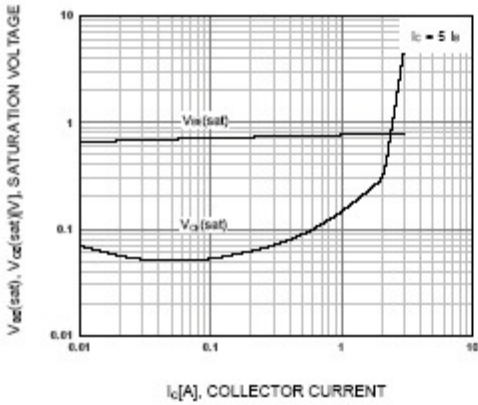

Figure 4. Base-Emitter On Voltage

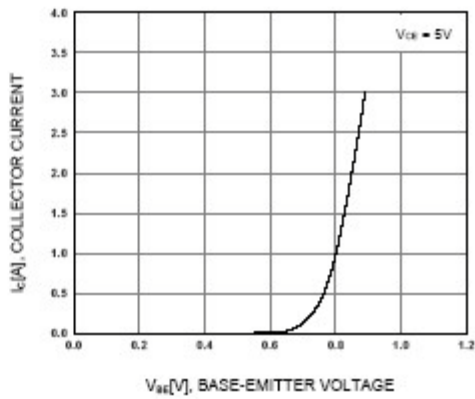

Figure 5. Switching Time

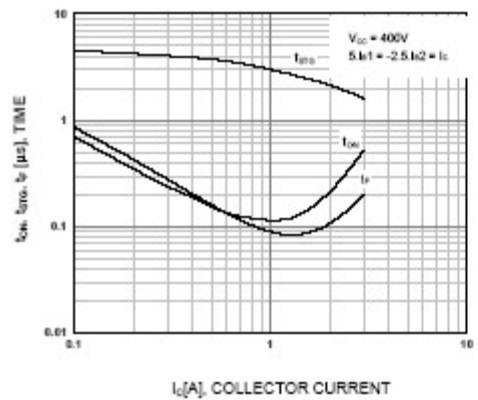
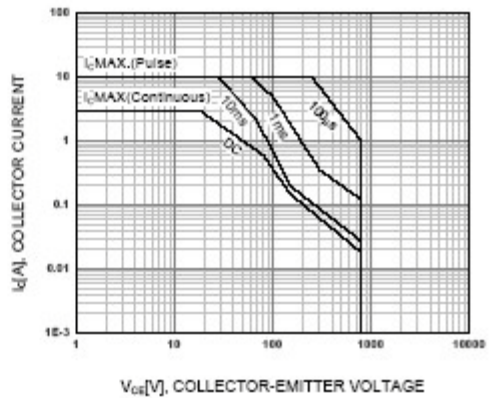

Figure 6. Safe Operating Area



Typical Characteristics (Continued)

Figure 7. Reverse Bias Operating Area

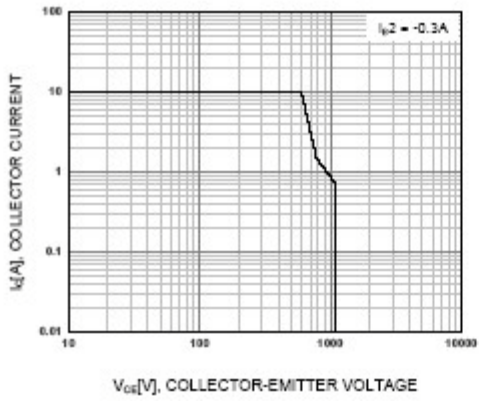
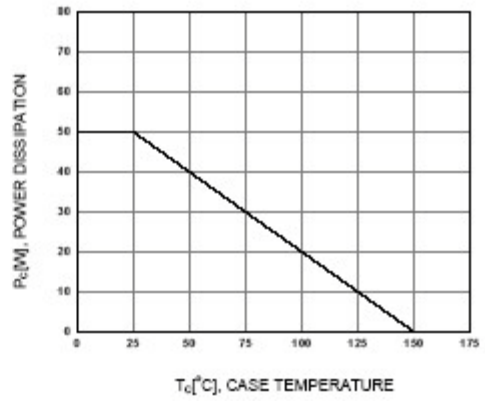
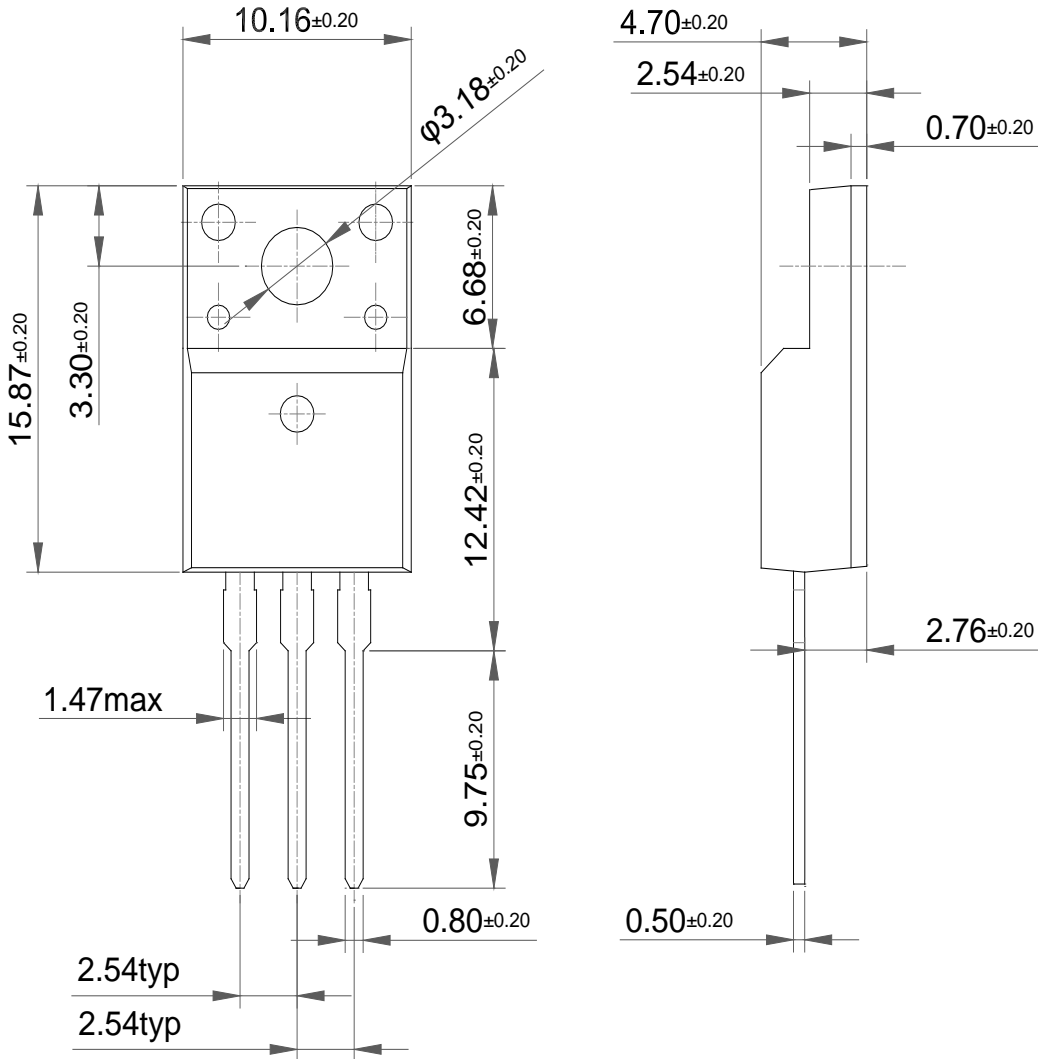

Figure 8. Power Derating



Package Dimension

# TO-220F



Dimensions in Millimeters