

# SBD Type : KSQ60A04E

OULINE DRAWING

**FEATURES**

- \* Similar to TO-247AC(TO-3P)Case
- \* Low Forward Voltage Drop
- \* Low Power Loss,High Efficiency
- \* High Surge Current Capability
- \* 30 Volts thru 60 Volts Types Available

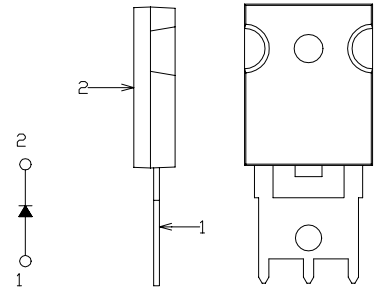

## Maximum Ratings

Approx Net Weight: 6.0g

Rating	Symbol	KSQ60A04E			Unit
Repetitive Peak Reverse Voltage	$V_{RRM}$	40			V
Average Rectified Output Current	$I_O$	60	$T_c=100^{\circ}C$	50 Hz half Sine Wave Resistive Load	A
RMS Forward Current	$I_{F(RMS)}$	94.2			A
Surge Forward Current	$I_{FSM}$	700	50Hz Half Sine Wave ,1cycle Non-repetitive		A
Operating JunctionTemperature Range	$T_{jw}$	-40 to +150			$^{\circ}C$
Storage Temperature Range	$T_{stg}$	-40 to +150			$^{\circ}C$
Mounting torque	$F_{tor}$	recommended torque = 0.5			N•m

## Electrical • Thermal Characteristics

Characteristics	Symbol	Conditions	Min.	Typ.	Max.	Unit
Peak Reverse Current	$I_{RM}$	$T_j= 25^{\circ}C, V_{RM}= V_{RRM}$	-	-	40	mA
Peak Forward Voltage	$V_{FM}$	$T_j= 25^{\circ}C, I_{FM}= 60 A$	-	-	0.62	V
Thermal Resistance	Junction to Case	$R_{th(j-c)}$ Junction to Case	-	-	0.75	$^{\circ}C/W$

KSQ\_E OUTLINE DRAWING (Dimensions in mm)

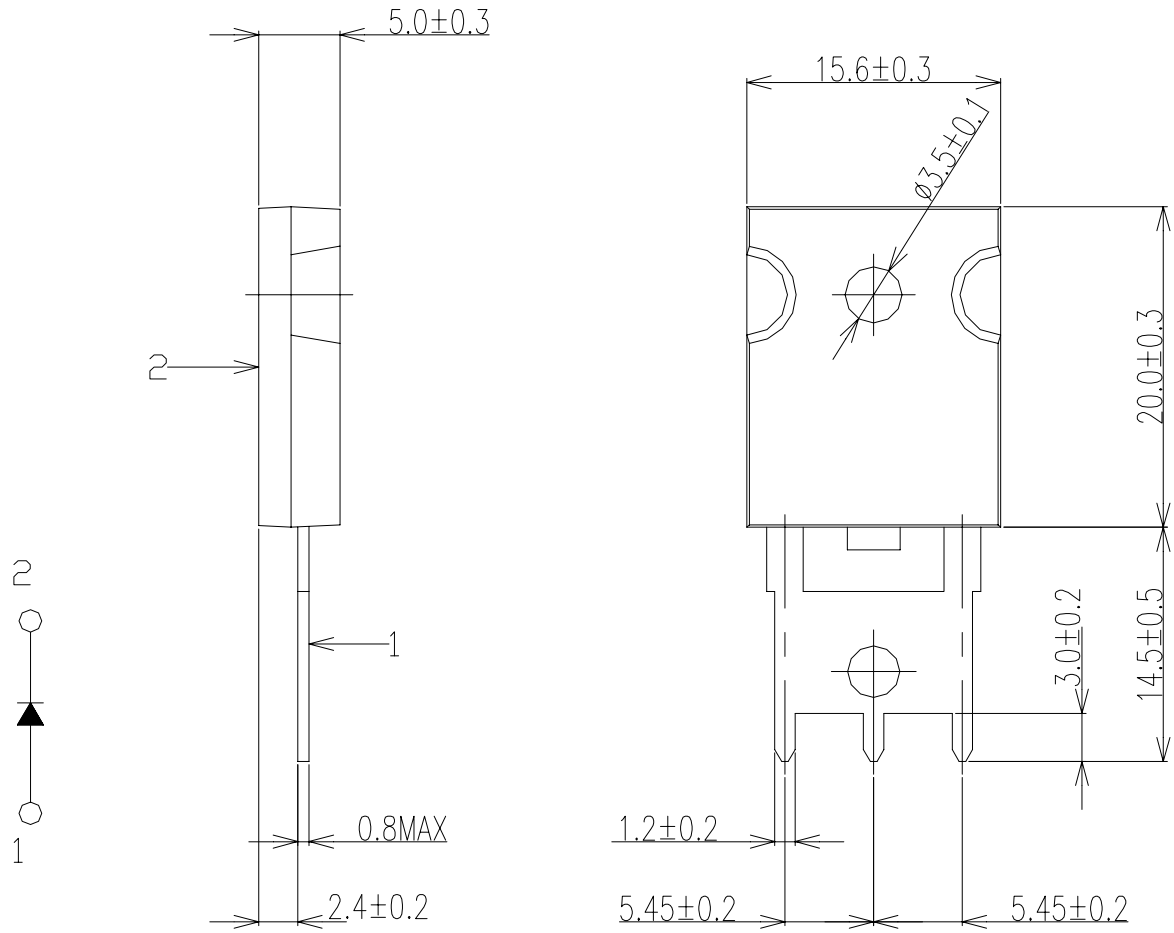

FORWARD CURRENT VS. VOLTAGE

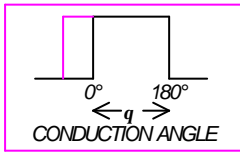
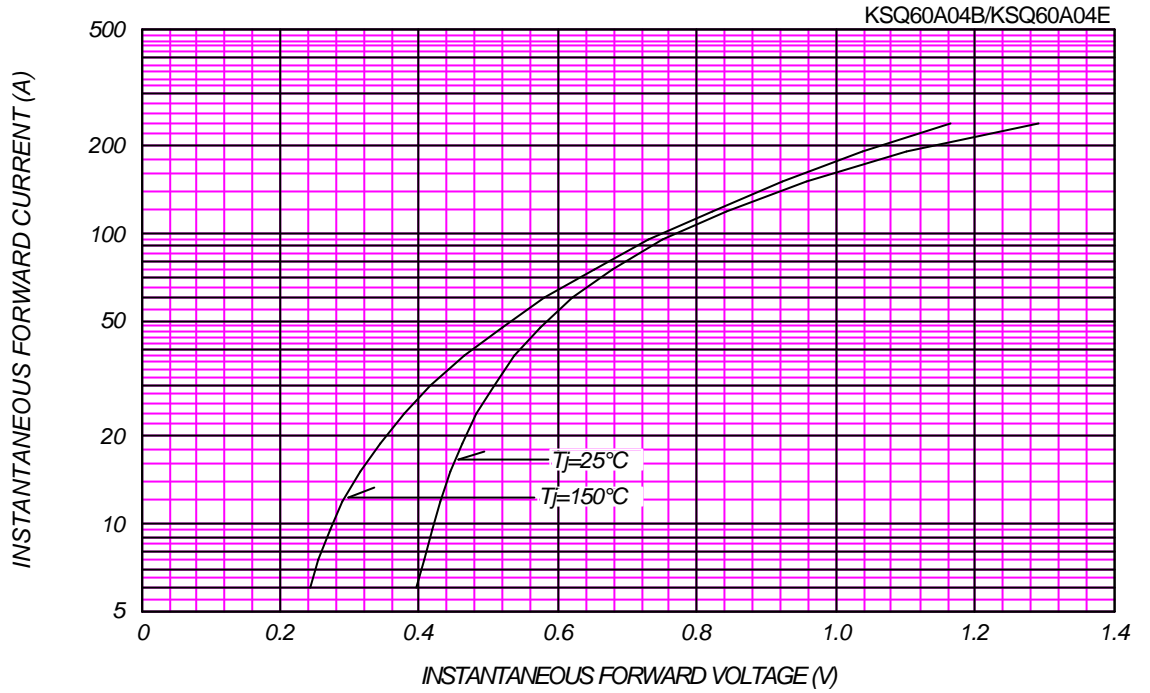

AVERAGE FORWARD POWER DISSIPATION

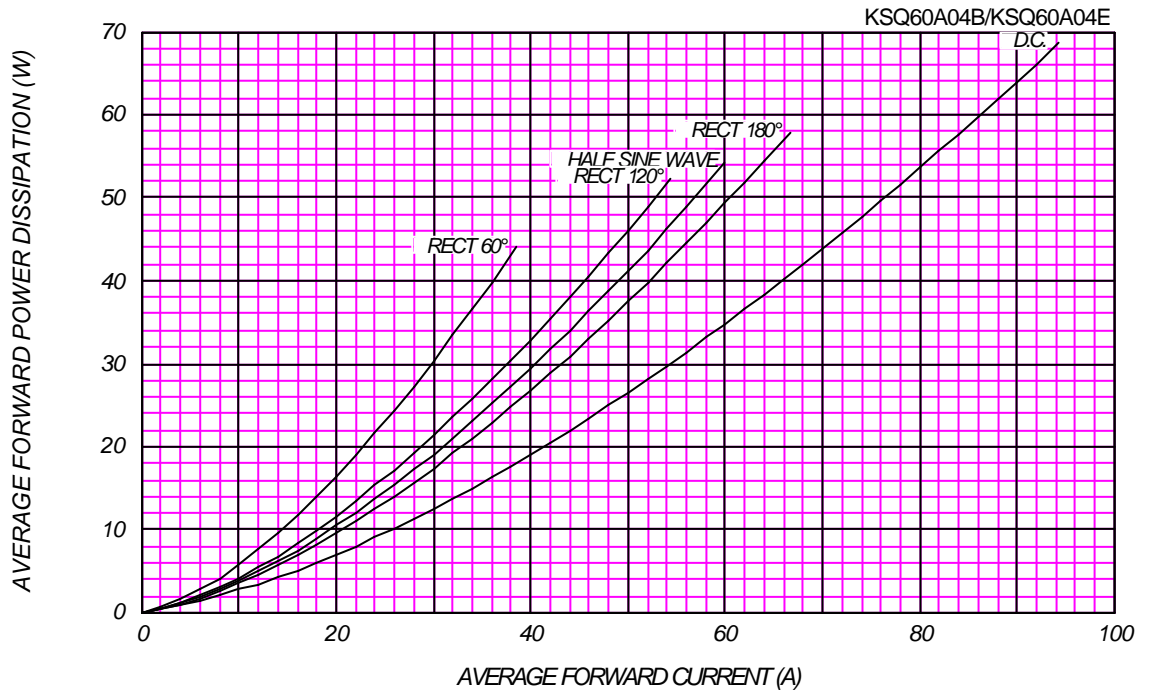

PEAK REVERSE CURRENT VS. PEAK REVERSE VOLTAGE

T<sub>j</sub> = 150 °C

KSQ60A04B/KSQ60A04E

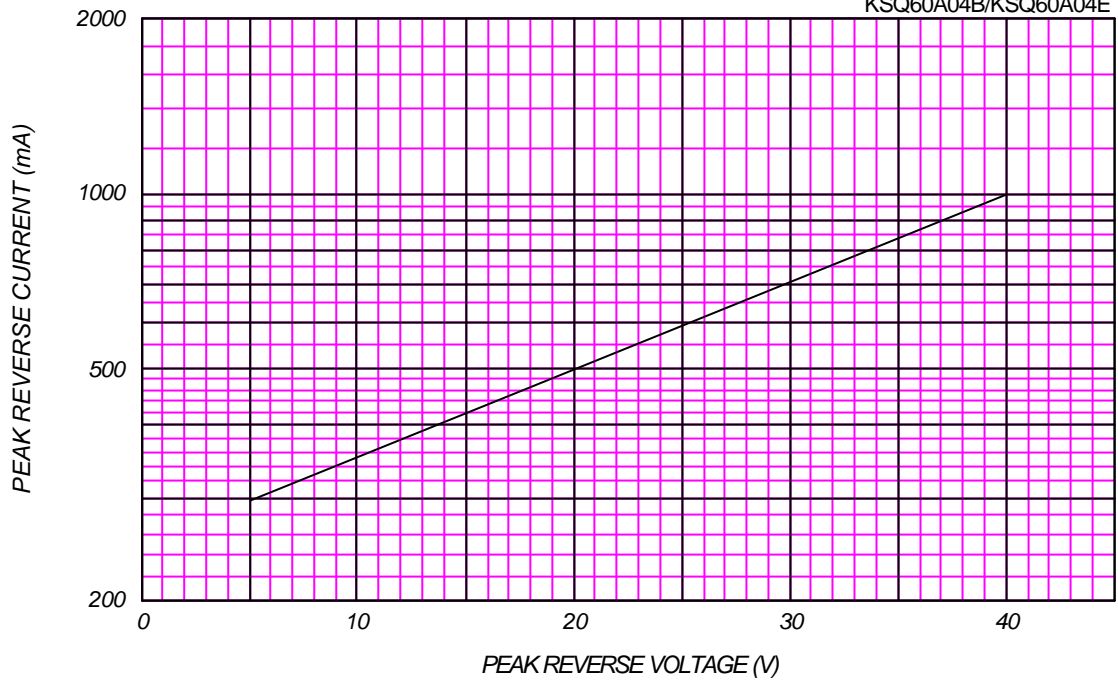

AVERAGE REVERSE POWER DISSIPATION

KSQ60A04B/KSQ60A04E

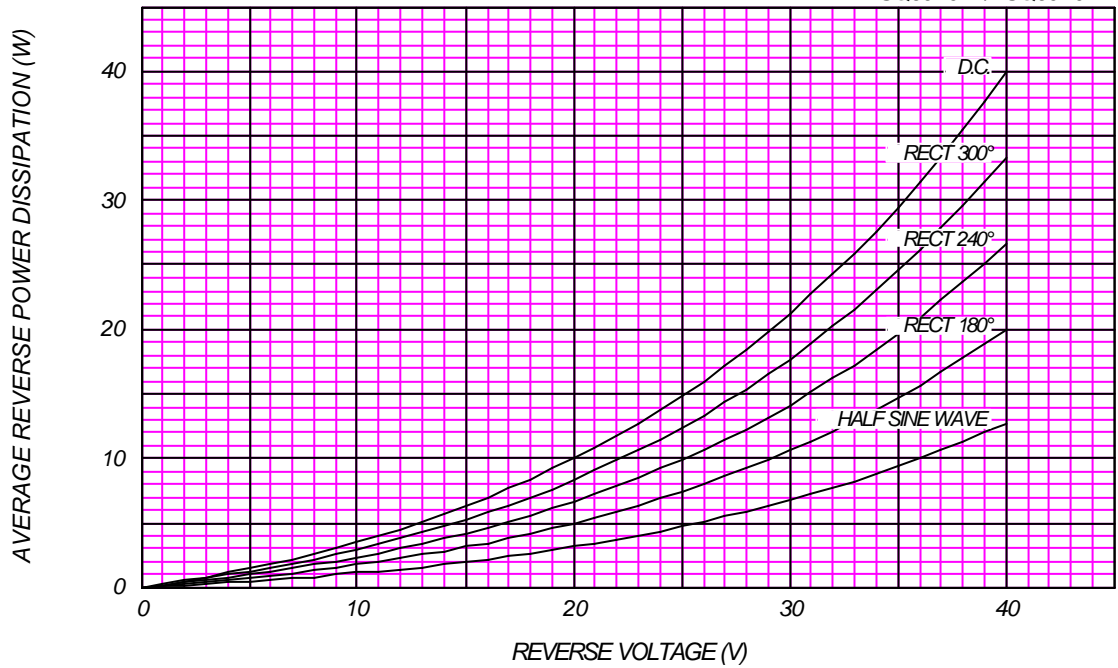

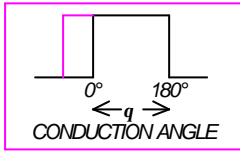

### AVERAGE FORWARD CURRENT VS. CASE TEMPERATURE

$V_{RM}=40V$

KSQ60A04B/KSQ60A04E

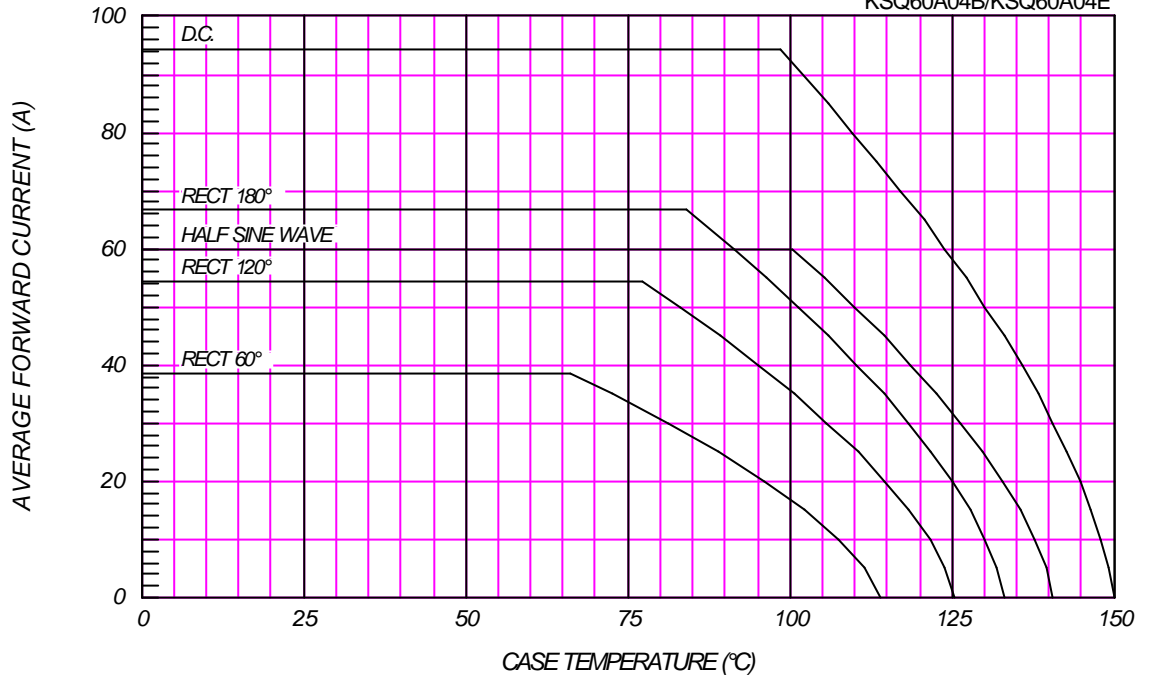

### SURGE CURRENT RATINGS

$f=50\text{Hz}$ , Half Sine Wave, Non-Repetitive, No Load

KSQ60A04B/KSQ60A04E

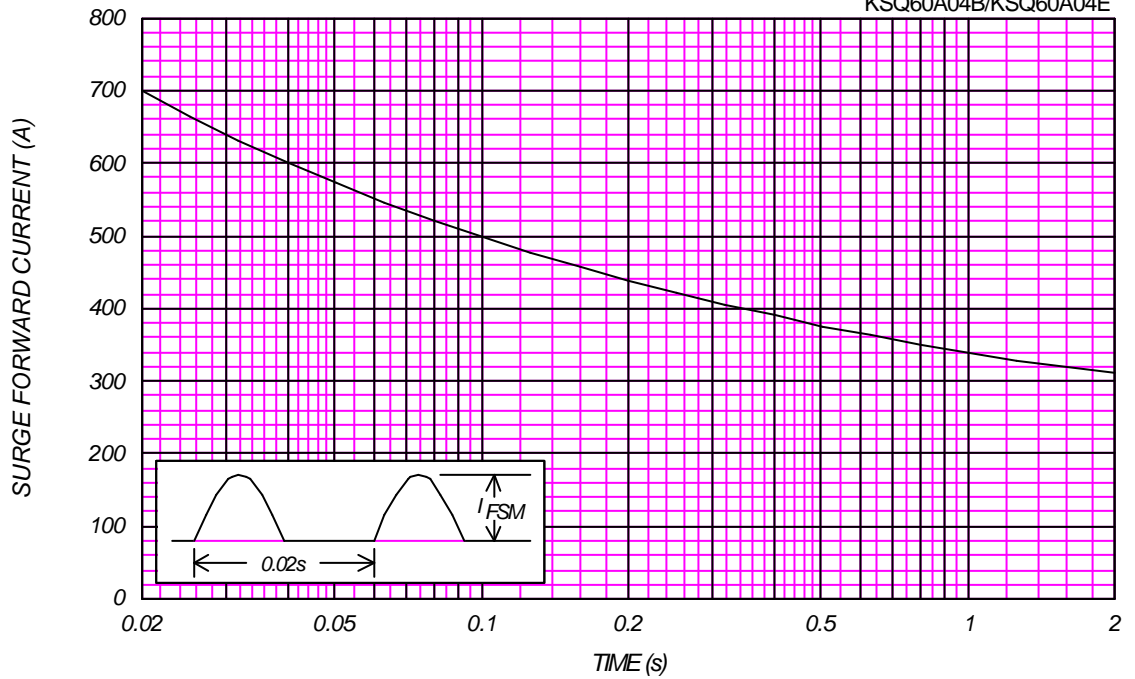

JUNCTION CAPACITANCE VS. REVERSE VOLTAGE

$T_j=25^\circ\text{C}$ ,  $V_m=20\text{mV}_{\text{RMS}}$ ,  $f=100\text{kHz}$ , Typical Value

KSQ60A04B/KSQ60A04E

