

# DATA SHEET

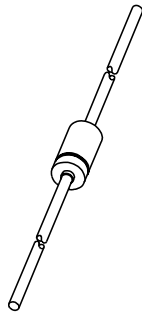

## **KTY83 series** Silicon temperature sensors

Product specification  
Supersedes data of 2000 Aug 25

2003 Sep 15

# Silicon temperature sensors

# KTY83 series

## DESCRIPTION

The temperature sensors in the KTY83-1 series have a positive temperature coefficient of resistance and are suitable for use in measurement and control systems. The sensors are encapsulated in the SOD68 (DO-34) package.

Tolerances of 0.5% or other special selections are available on request.

## MARKING

TYPE NUMBER	MARKING CODE
KTY83/110	KT83A
KTY83/120	KT83C
KTY83/121	KT83D
KTY83/122	KT83E
KTY83/150	KT83H
KTY83/151	KT83K

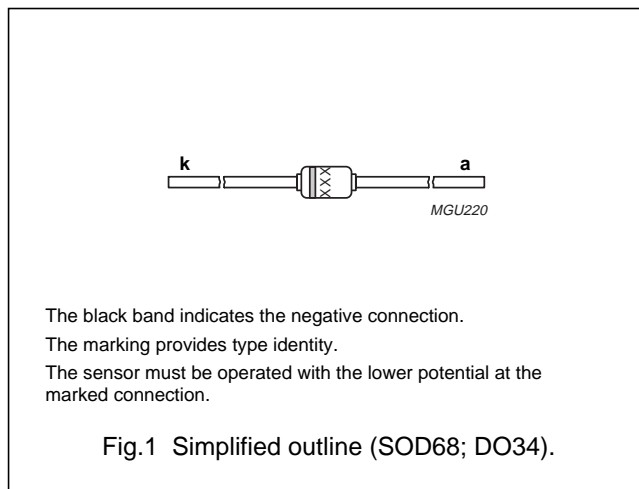

## QUICK REFERENCE DATA

SYMBOL	PARAMETER	CONDITIONS	MIN.	MAX.	UNIT
R <sub>25</sub>	sensor resistance	T <sub>amb</sub> = 25 °C; I <sub>cont</sub> = 1 mA			
	KTY83/110		990	1010	Ω
	KTY83/120		980	1020	Ω
	KTY83/121		980	1000	Ω
	KTY83/122		1000	1020	Ω
	KTY83/150		950	1050	Ω
	KTY83/151	950	1000	Ω	
T <sub>amb</sub>	ambient operating temperature		-55	+175	°C

## LIMITING VALUES

In accordance with the Absolute Maximum Rating System (IEC 60134).

SYMBOL	PARAMETER	CONDITIONS	MIN.	MAX.	UNIT
I <sub>cont</sub>	continuous sensor current	in free air; T <sub>amb</sub> = 25 °C	-	10	mA
		in free air; T <sub>amb</sub> = 175 °C	-	2	mA
T <sub>amb</sub>	ambient operating temperature		-55	+175	°C

## Silicon temperature sensors

## KTY83 series

**CHARACTERISTICS**

$T_{amb} = 25\text{ °C}$  in liquid unless otherwise specified.

SYMBOL	PARAMETER	CONDITIONS	MIN.	TYP.	MAX.	UNIT
R <sub>25</sub>	sensor resistance	I <sub>cont</sub> = 1 mA				
	KTY83/110		990	–	1010	Ω
	KTY83/120		980	–	1020	Ω
	KTY83/121		980	–	1000	Ω
	KTY83/122		1000	–	1020	Ω
	KTY83/150		950	–	1050	Ω
	KTY83/151	950	–	1000	Ω	
TC	temperature coefficient		–	0.76	–	%/K
R <sub>100</sub> /R <sub>25</sub>	resistance ratio	T <sub>amb</sub> = 100 °C and 25 °C	1.65	1.67	1.69	
R <sub>-55</sub> /R <sub>25</sub>	resistance ratio	T <sub>amb</sub> = -55 °C and 25 °C	0.49	0.50	0.51	
τ	thermal time constant; note 1	in still air	–	20	–	s
		in still liquid; note 2	–	1	–	s
		in flowing liquid; note 2	–	0.5	–	s
	rated temperature range		-55	–	+175	°C

**Notes**

- The thermal time constant is the time taken for the sensor to reach 63.2% of the total temperature difference.  
For example, if a sensor with a temperature of 25 °C is moved to an environment with an ambient temperature of 100 °C, the time for the sensor to reach a temperature of 72.4 °C is the thermal time constant.
- Inert liquid, e.g. FC43 manufactured by the 3M company.

## Silicon temperature sensors

## KTY83 series

**Table 1** Ambient temperature, corresponding resistance, temperature coefficient and maximum expected temperature error for KTY83/110 and KTY83/120 $I_{\text{cont}} = 1 \text{ mA}$ .

AMBIENT TEMPERATURE		TEMP. COEFF. (%/K)	KTY83/110				KTY83/120			
(°C)	(°F)		RESISTANCE (Ω)			TEMP. ERROR (K)	RESISTANCE (Ω)			TEMP. ERROR (K)
		MIN.	TYP.	MAX.	MIN.		TYP.	MAX.		
-55	-67	0.97	485	500	515	±3.08	480	500	520	±4.11
-50	-58	0.96	510	525	540	±2.99	504	525	545	±4.04
-40	-40	0.93	562	577	592	±2.81	556	577	598	±3.88
-30	-22	0.91	617	632	647	±2.62	611	632	654	±3.72
-20	-4	0.88	677	691	706	±2.42	670	691	713	±3.56
-10	14	0.85	740	754	768	±2.2	732	754	776	±3.37
0	32	0.83	807	820	833	±1.97	798	820	841	±3.18
10	50	0.80	877	889	902	±1.72	868	889	910	±2.97
20	68	0.78	951	962	973	±1.45	942	962	983	±2.74
25	77	0.76	990	1000	1010	±1.31	980	1000	1020	±2.62
30	86	0.75	1027	1039	1050	±1.44	1017	1039	1060	±2.77
40	104	0.73	1105	1118	1132	±1.7	1093	1118	1143	±3.07
50	122	0.71	1185	1202	1219	±1.98	1173	1202	1231	±3.39
60	140	0.69	1268	1288	1309	±2.27	1255	1288	1321	±3.73
70	158	0.67	1355	1379	1402	±2.58	1341	1379	1416	±4.08
80	176	0.65	1445	1472	1500	±2.9	1430	1472	1515	±4.44
90	194	0.63	1537	1569	1601	±3.24	1522	1569	1617	±4.82
100	212	0.61	1633	1670	1707	±3.59	1617	1670	1723	±5.22
110	230	0.60	1732	1774	1816	±3.95	1714	1774	1834	±5.63
120	248	0.58	1834	1882	1929	±4.34	1815	1882	1948	±6.06
125	257	0.57	1886	1937	1987	±4.53	1867	1937	2006	±6.28
130	266	0.57	1939	1993	2046	±4.73	1919	1993	2066	±6.5
140	284	0.55	2047	2107	2167	±5.14	2026	2107	2188	±6.96
150	302	0.54	2158	2225	2292	±5.57	2136	2225	2314	±7.43
160	320	0.52	2272	2346	2420	±6.02	2249	2346	2444	±7.92
170	338	0.51	2389	2471	2553	±6.47	2364	2471	2578	±8.43
175	347	0.51	2449	2535	2621	±6.71	2423	2535	2646	±8.68

## Silicon temperature sensors

## KTY83 series

**Table 2** Ambient temperature, corresponding resistance, temperature coefficient and maximum expected temperature error for KTY83/121 and KTY83/122 $I_{\text{cont}} = 1 \text{ mA}$ .

AMBIENT TEMPERATURE		TEMP. COEFF. (%/K)	KTY83/121				KTY83/122			
(°C)	(°F)		RESISTANCE (Ω)			TEMP. ERROR (K)	RESISTANCE (Ω)			TEMP. ERROR (K)
		MIN.	TYP.	MAX.	MIN.		TYP.	MAX.		
-55	-67	0.97	480	495	510	±3.08	490	505	520	±3.08
-50	-58	0.96	505	519	534	±2.99	515	530	545	±2.99
-40	-40	0.93	556	571	586	±2.81	567	583	598	±2.81
-30	-22	0.91	611	626	641	±2.62	624	639	654	±2.62
-20	-4	0.88	670	685	699	±2.42	684	698	713	±2.42
-10	14	0.85	732	746	760	±2.2	747	762	776	±2.2
0	32	0.83	799	812	825	±1.97	815	828	842	±1.97
10	50	0.80	868	880	893	±1.72	886	898	911	±1.72
20	68	0.78	942	953	963	±1.45	961	972	983	±1.45
25	77	0.76	980	990	1000	±1.31	1000	1010	1020	±1.31
30	86	0.75	1017	1028	1039	±1.44	1038	1049	1060	±1.44
40	104	0.73	1094	1107	1121	±1.7	1116	1130	1144	±1.7
50	122	0.71	1173	1190	1206	±1.98	1197	1214	1231	±1.98
60	140	0.69	1256	1276	1295	±2.27	1281	1301	1322	±2.27
70	158	0.67	1341	1365	1388	±2.58	1368	1392	1416	±2.58
80	176	0.65	1430	1458	1485	±2.9	1459	1487	1515	±2.9
90	194	0.63	1522	1554	1585	±3.24	1553	1585	1617	±3.24
100	212	0.61	1617	1653	1690	±3.59	1650	1687	1724	±3.59
110	230	0.60	1715	1756	1798	±3.95	1750	1792	1834	±3.95
120	248	0.58	1816	1863	1910	±4.34	1853	1900	1948	±4.34
125	257	0.57	1867	1917	1967	±4.53	1905	1956	2007	±4.53
130	266	0.57	1920	1973	2025	±4.73	1959	2012	2066	±4.73
140	284	0.55	2027	2086	2145	±5.14	2068	2128	2188	±5.14
150	302	0.54	2137	2203	2269	±5.57	2180	2247	2314	±5.57
160	320	0.52	2249	2323	2396	±6.02	2295	2370	2444	±6.02
170	338	0.51	2365	2446	2527	±6.47	2413	2496	2578	±6.47
175	347	0.51	2424	2509	2595	±6.71	2473	2560	2647	±6.71

## Silicon temperature sensors

## KTY83 series

**Table 3** Ambient temperature, corresponding resistance, temperature coefficient and maximum expected temperature error for KTY83/150 and KTY83/151 $I_{\text{cont}} = 1 \text{ mA}$ .

AMBIENT TEMPERATURE		TEMP. COEFF. (%/K)	KTY83/150				KTY83/151			
(°C)	(°F)		RESISTANCE (Ω)			TEMP. ERROR (K)	RESISTANCE (Ω)			TEMP. ERROR (K)
		MIN.	TYP.	MAX.	MIN.		TYP.	MAX.		
-55	-67	0.97	465	500	535	±7.19	466	487	509	±4.92
-50	-58	0.96	489	525	561	±7.16	489	512	534	±4.56
-40	-40	0.93	539	577	615	±7.1	539	562	586	±4.42
-30	-22	0.91	592	632	673	±7.04	593	617	641	±4.28
-20	-4	0.88	649	691	734	±6.97	650	674	699	±4.12
-10	14	0.85	710	754	798	±6.9	710	735	760	±3.96
0	32	0.83	774	820	866	±6.81	774	799	824	±3.79
10	50	0.80	842	889	937	±6.72	842	867	892	±3.59
20	68	0.78	913	962	1012	±6.61	914	938	963	±3.39
25	77	0.76	950	1000	1050	±6.55	950	975	1000	±3.27
30	86	0.75	986	1039	1091	±6.76	987	1013	1039	±3.43
40	104	0.73	1060	1118	1177	±7.19	1061	1090	1120	±3.76
50	122	0.71	1137	1202	1267	±7.63	1138	1172	1206	±4.1
60	140	0.69	1217	1288	1360	±8.1	1218	1256	1295	±4.45
70	158	0.67	1300	1379	1457	±8.58	1301	1344	1387	±4.83
80	176	0.65	1386	1472	1559	±9.07	1387	1435	1484	±5.21
90	194	0.63	1475	1569	1664	±9.59	1476	1530	1584	±5.62
100	212	0.61	1566	1670	1773	±10.12	1568	1628	1688	±6.04
110	230	0.60	1661	1774	1887	±10.66	1663	1730	1796	±6.47
120	248	0.58	1759	1882	2004	±11.282	1761	1835	1908	±6.92
125	257	0.57	1809	1937	2064	±11.51	1811	1888	1966	±7.15
130	266	0.57	1859	1993	2126	±11.8	1862	1943	2024	±7.38
140	284	0.55	1963	2107	2251	±12.4	1965	2054	2143	±7.87
150	302	0.54	2069	2225	2380	±13.01	2072	2169	2267	±8.36
160	320	0.52	2178	2346	2514	±13.64	2181	2288	2394	±8.87
170	338	0.51	2290	2471	2652	±14.28	2293	2409	2525	±9.4
175	347	0.51	2347	2535	2722	±14.61	2350	2471	2592	±9.67

Silicon temperature sensors

KTY83 series

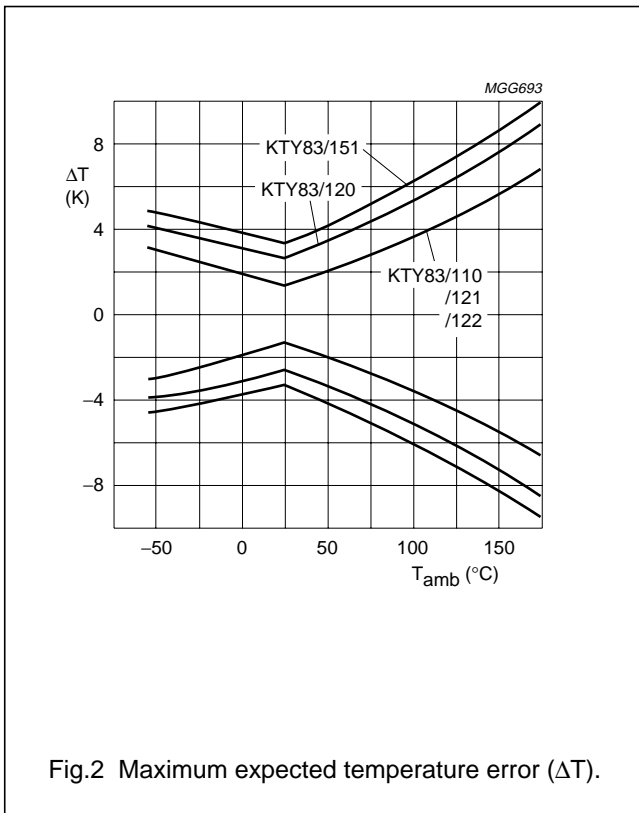

Fig.2 Maximum expected temperature error ( $\Delta T$ ).

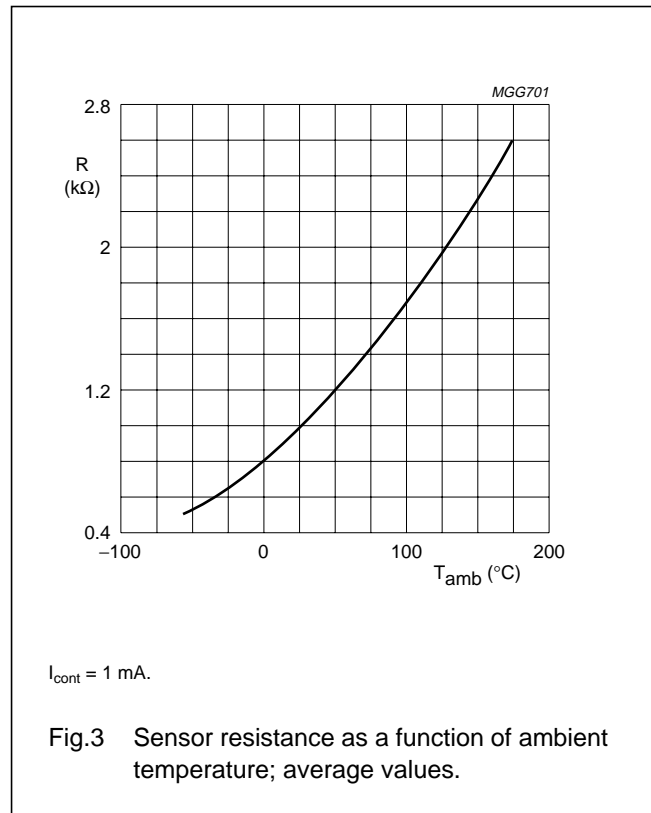
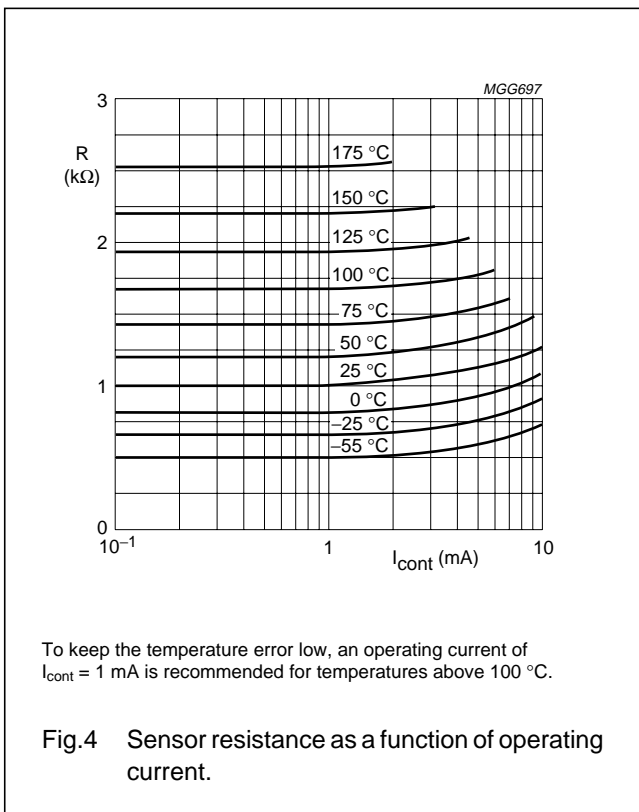

Fig.3 Sensor resistance as a function of ambient temperature; average values.



To keep the temperature error low, an operating current of  $I_{cont} = 1 \text{ mA}$  is recommended for temperatures above 100 °C.

Fig.4 Sensor resistance as a function of operating current.

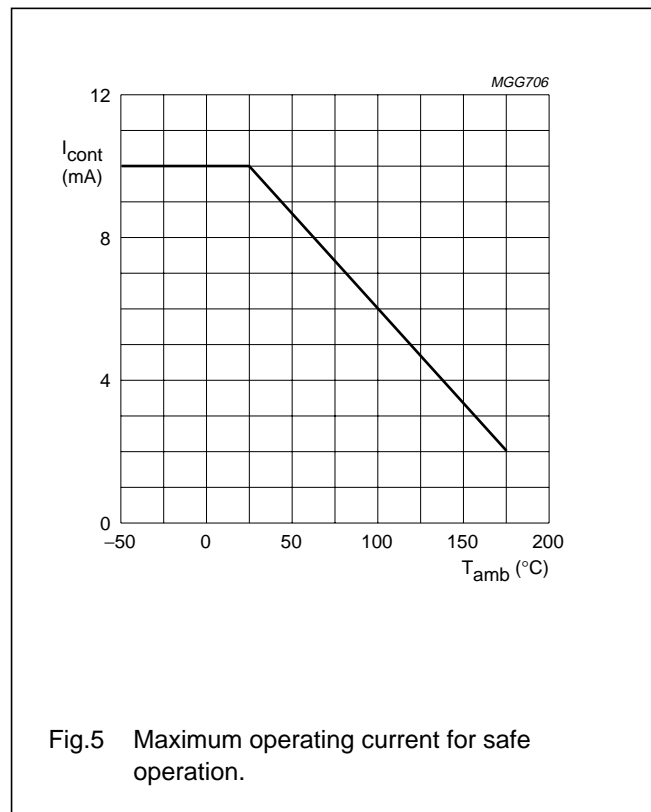
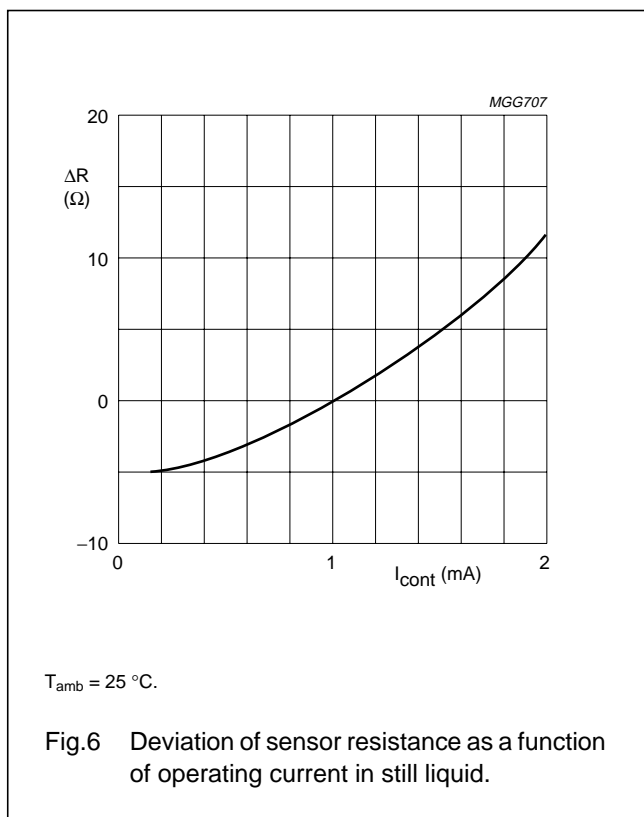

Fig.5 Maximum operating current for safe operation.

Silicon temperature sensors

KTY83 series



**APPLICATION INFORMATION**

SYMBOL	PARAMETER	CONDITIONS	TYP.	UNIT
$\Delta R_{25}$	drift of sensor resistance at 25 °C	10000 hours continuous operation; $T_{amb} = 175\text{ }^{\circ}\text{C}$	1	$\Omega$



Silicon temperature sensors

KTY83 series

PACKAGE OUTLINE

Hermetically sealed glass package; axial leaded; 2 leads

SOD68

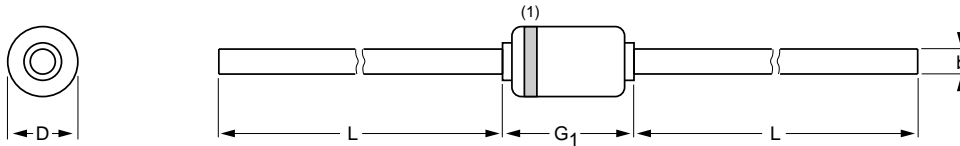

DIMENSIONS (mm are the original dimensions)

UNIT	b max.	D max.	G <sub>1</sub> max.	L min.
mm	0.55	1.6	3.04	25.4

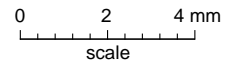

Note

1. The marking band indicates the cathode.

OUTLINE VERSION	REFERENCES				EUROPEAN PROJECTION	ISSUE DATE
	IEC	JEDEC	EIAJ			
SOD68		DO-34				97-06-09

## Silicon temperature sensors

## KTY83 series

## DATA SHEET STATUS

LEVEL	DATA SHEET STATUS <sup>(1)</sup>	PRODUCT STATUS <sup>(2)(3)</sup>	DEFINITION
I	Objective data	Development	This data sheet contains data from the objective specification for product development. Philips Semiconductors reserves the right to change the specification in any manner without notice.
II	Preliminary data	Qualification	This data sheet contains data from the preliminary specification. Supplementary data will be published at a later date. Philips Semiconductors reserves the right to change the specification without notice, in order to improve the design and supply the best possible product.
III	Product data	Production	This data sheet contains data from the product specification. Philips Semiconductors reserves the right to make changes at any time in order to improve the design, manufacturing and supply. Relevant changes will be communicated via a Customer Product/Process Change Notification (CPCN).

## Notes

1. Please consult the most recently issued data sheet before initiating or completing a design.
2. The product status of the device(s) described in this data sheet may have changed since this data sheet was published. The latest information is available on the Internet at URL <http://www.semiconductors.philips.com>.
3. For data sheets describing multiple type numbers, the highest-level product status determines the data sheet status.

## DEFINITIONS

**Short-form specification** — The data in a short-form specification is extracted from a full data sheet with the same type number and title. For detailed information see the relevant data sheet or data handbook.

**Limiting values definition** — Limiting values given are in accordance with the Absolute Maximum Rating System (IEC 60134). Stress above one or more of the limiting values may cause permanent damage to the device. These are stress ratings only and operation of the device at these or at any other conditions above those given in the Characteristics sections of the specification is not implied. Exposure to limiting values for extended periods may affect device reliability.

**Application information** — Applications that are described herein for any of these products are for illustrative purposes only. Philips Semiconductors make no representation or warranty that such applications will be suitable for the specified use without further testing or modification.

## DISCLAIMERS

**Life support applications** — These products are not designed for use in life support appliances, devices, or systems where malfunction of these products can reasonably be expected to result in personal injury. Philips Semiconductors customers using or selling these products for use in such applications do so at their own risk and agree to fully indemnify Philips Semiconductors for any damages resulting from such application.

**Right to make changes** — Philips Semiconductors reserves the right to make changes in the products - including circuits, standard cells, and/or software - described or contained herein in order to improve design and/or performance. When the product is in full production (status 'Production'), relevant changes will be communicated via a Customer Product/Process Change Notification (CPCN). Philips Semiconductors assumes no responsibility or liability for the use of any of these products, conveys no licence or title under any patent, copyright, or mask work right to these products, and makes no representations or warranties that these products are free from patent, copyright, or mask work right infringement, unless otherwise specified.

# ***Philips Semiconductors – a worldwide company***

## **Contact information**

For additional information please visit <http://www.semiconductors.philips.com>. Fax: +31 40 27 24825

For sales offices addresses send e-mail to: [sales.addresses@www.semiconductors.philips.com](mailto:sales.addresses@www.semiconductors.philips.com).

© Koninklijke Philips Electronics N.V. 2003

SCA75

All rights are reserved. Reproduction in whole or in part is prohibited without the prior written consent of the copyright owner.

The information presented in this document does not form part of any quotation or contract, is believed to be accurate and reliable and may be changed without notice. No liability will be accepted by the publisher for any consequence of its use. Publication thereof does not convey nor imply any license under patent- or other industrial or intellectual property rights.

Printed in The Netherlands

R75/05/pp11

Date of release: 2003 Sep 15

Document order number: 9397 750 11748

*Let's make things better.*

**Philips  
Semiconductors**



**PHILIPS**