

KYL-300L Low Power Wireless Transceiver Data Module



Shenzhen KYL Communication Equipment Co., Ltd

Add: 3705-3707, Building C, Huangdu Square, Yitian Road, Futian District,
Shenzhen, Guangdong, China 518048

Tel: 86-755-83410815; 86-755-82943662

Email: sales01@rf-data.com; sales02@rf-data.com

Fax: 86-755-83408785

Web: www.rf-data.com

Catalogue

I. About KYL-300L	3
II. Features of KYL-300L	3
III. Applications of KYL-300L.....	4
IV. How to use KYL-300L.....	4
V. Networking Application of KYL-300L.....	14
VI. Technical specification of KYL-300L.....	14
VII. Description of type.....	15

Before using our products, please read the user manual carefully. Any questions, feel free to contact us at the above mentioned methods.

I: About KYL-300L

KYL-300L is a kind of low power wireless transceiver data module. With small size, low power consumption as well as good stability and reliability, it is widely used as wireless data transceiver in long-ranges, narrowband low power UHF wireless data transmitters and receivers with channel spacing as low as 25 KHz.

II: Features of KYL-300L:

- 1. Low power transmission:** 500mW (default), 600mW~1W (optional).
- 2. Carrier frequency:** 433MHz (default), 400-470MHz, 868MHz, 915MHz (optional)
- 3. High anti- interference and Low BER (Bit Error Rate)**

Based on GFSK modulation, high-efficiency forward error correction channel encoding technology is used to ensure the data's resistance against both transient interference and random interference. The actual BER can be achieved to $10^{-5} \sim 10^{-6}$ when channel BER is 10^{-2} .
- 4. Long Transmission Distance**

Within the visible range, when the height of antenna is higher than 2m and the BER is 10^{-3} , the reliable transmission distance is 3000m @1200bps and 2000m@9600bps respectively.
- 5. Transparent data transmission**

Transparent data interface used in transceivers is to satisfy many standard and nonstandard user protocols. Any false data generated in air can be filtrated automatically (What has been received is exactly what has been transmitted).
- 6. Multi-channels**

KYL-300L provides 8 channels, expandable for 16, 32 channels according to requirements of users.
- 7. 2 ports with three connection methods**

KYL-300L transceivers provide 2 ports with three connections, a UART interface of TTL level, a non-standard RS-232 port and a non-standard RS-485 port. USB interface port is also available. It can get the power for the PC directly
- 8. Big data buffer area**

With optional interface baud rates: 1200/4800/9600/19200bps and 8N1/8E1/8O1 data format (decide by user), the transceiver can transmit unlimited data frames with flexible user program.

Note: the RF data rate is only settled down before delivery; please specify our sales your requirements when placing your orders.
- 9. Intelligent data control system and no other extra programs required**

Even for half duplex communication, no other excessive programs are required. All RF system data transmission/reception and other On-the-Fly conversion and control are performed by KYL-300L transceivers automatically.

10. Lower power consumption & nice sleep function

With +5V power, the receiving current is less than 25mA, the transmitting current is less than 300mA, and the sleeping current is less than 20uA.

11. High reliability, small size and excellent performance

By using monolithic radio-frequency integrated circuit and single-chip MCU, the transceivers have less peripheral circuits, high reliability, and low failure rate.

12. Various options for configurable antennas.

13. Watchdog monitor inside

Watchdog monitors the inner operation, so it can change the traditional product structure and also improve the reliability of our modules.

14. With beautiful metal shell.

III: Application of KYL-300L:

KYL-300L the lower power wireless transceiver data module is suitable for:

KYL-200L is suitable for:

- * Automatic Meter Reading (AMR);
- * Wireless alarm and security systems;
- * Building automation, security systems, wireless monitor, remote control and access control system;
- * Wireless data transmission, automatic data collection system;
- * Radio modem can be used for Sports training & competition;
- * Wireless dishes ordering;
- * Wireless POS, PDA wireless smart terminal;
- * RF module can be used for electronic bus station and intelligent traffics;
- * RF transmitter, Wireless electronic display screen and Queuing machine;
- * Wireless telemetry; charging for parking, parking lot;
- * Wireless modem automobile inspection and four-wheel orientation;
- * Wireless sensor, Industrial wireless remote control and air conditioning remote controller;
- * Data communication in the aspects of railway, oil field, dock and army.
- * LED display in thruway and public place;
- * Point to multi-point wireless network, wireless on-the-spot bus and automatic data collection system

IV: How to use the KYL-300L

KYL-300L provide RS-232, RS-485 and UART/TTL level interface port for direct connection with PC, RS485 devices, monolithic processors and other UART components kinds of applications. The schematic diagram is shown below:

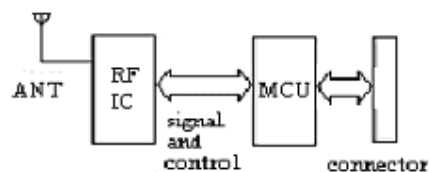

KYL-300L Principle map

1. Power supply

The factory setting is +5V (needing 7.5V-12V, please notify us when placing the order). Using better ripple factor, KYL-300L transceivers can also share power supply with other equipment. If possible, a voltage-stabilizing chip with 5V voltage is much more recommended than Switch power supply. But if only switch power supply is available, the jam caused by switch pulse should be avoided. In addition, the reliable grounding must be used if there is other device in the system equipment. In case of failing to connect with the ground, it can form its own grounding but must be absolutely separated from the municipal electric supply.

2. Connection Definition with terminal

KYL-300L transceivers supply one 9-pin connector (JP1), their definitions and connection methods with terminals are shown in Table 1.

Table 1: JP1 Pin Definitions and connection methods

Pin No.	Signal Name	Function	Level	Connection with terminal	Remarks
1	GND	Grounding of power supply		Ground	
2	Vcc	Power supply DC	5V		
3	RxD/TTL	Serial data input to the transceiver	TTL	TxD	
4	TxD/TTL	Transmitted data out of the transceiver	TTL	RxD	
5	SGND	Signal			
6	A (TXD)	A of RS-485(TxD of RS-232)		A(RxD)	
7	B (RXD)	B of RS-485(RxD of RS-232)		B(TxD)	
8	SLEEP	Sleep control (input)	TTL	Sleep signal	High level sleep
9	RESET	Reset signal(input)	TTL		Negative pulse reset

3. The connection schematic diagram between computer and our RF module

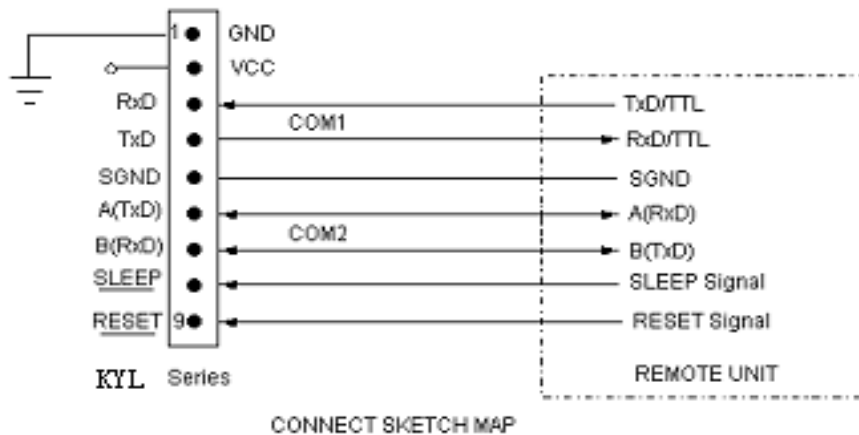

4. Setting of channel, interface, and data format

Before using KYL-300L, the user needs to make simple configuration to determine the channel, interface mode and data format based on his own needs. You can view or change the module's interface baud rate, channel and address code, parameter setting or reading as per the testing software KYLCOM in the PC (in products box). And the configuration is as follows:

i. Channel configuration:

Channel No.	Frequency	Channel No.	Frequency
1	429.0325MHZ	5	433.0325MHZ
2	430.0325MHZ	6	434.0325MHZ
3	431.0325MHZ	7	435.0325MHZ
4	432.0325MHZ	8	436.0325MHZ

Note: the frequency points corresponding to each channel can be adjusted based on the user's needs.

ii. The schematic diagram of setting the parameter as follows:

- a. Connect the PC and module with RS232 data cable.
- b. Open the "KYLCOM" PC software, then select "English" as follows:



. Click “open port” then will open a small window as the following picture, clients will write the parameters in this column.

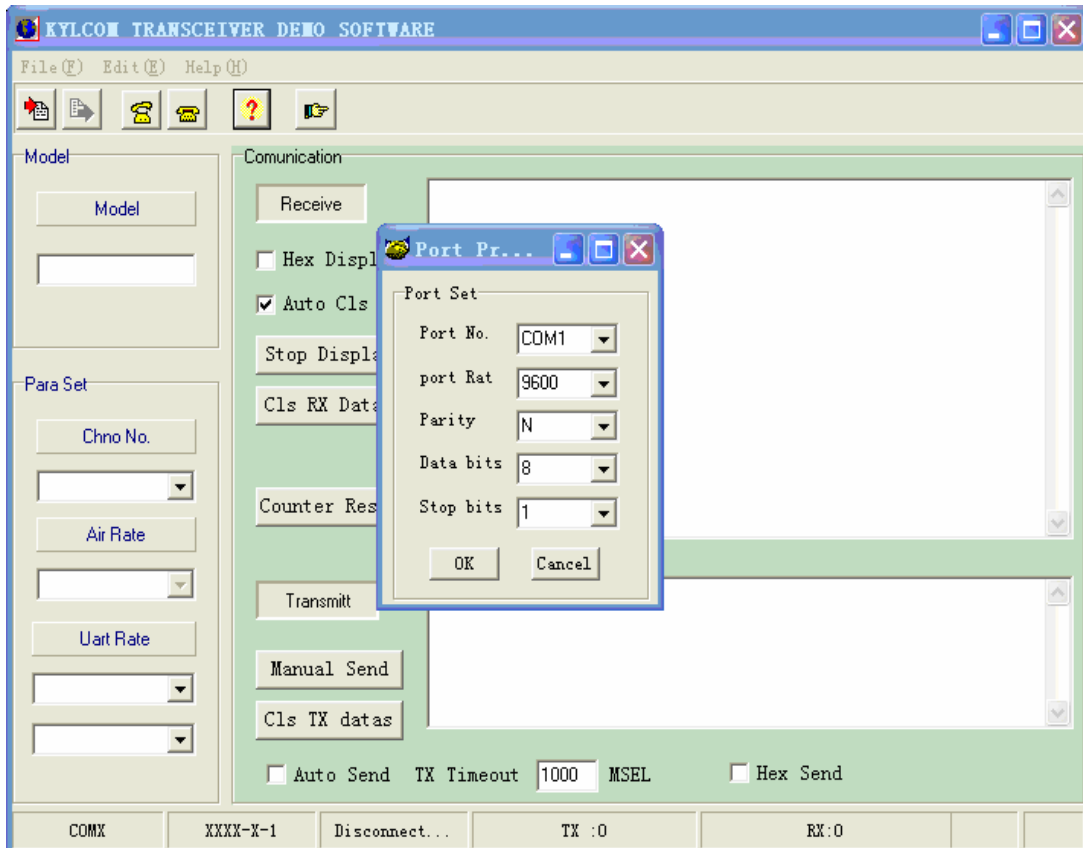

. Click “read paras”.

“Read correct” show your connection between KYL module and PC is correct.

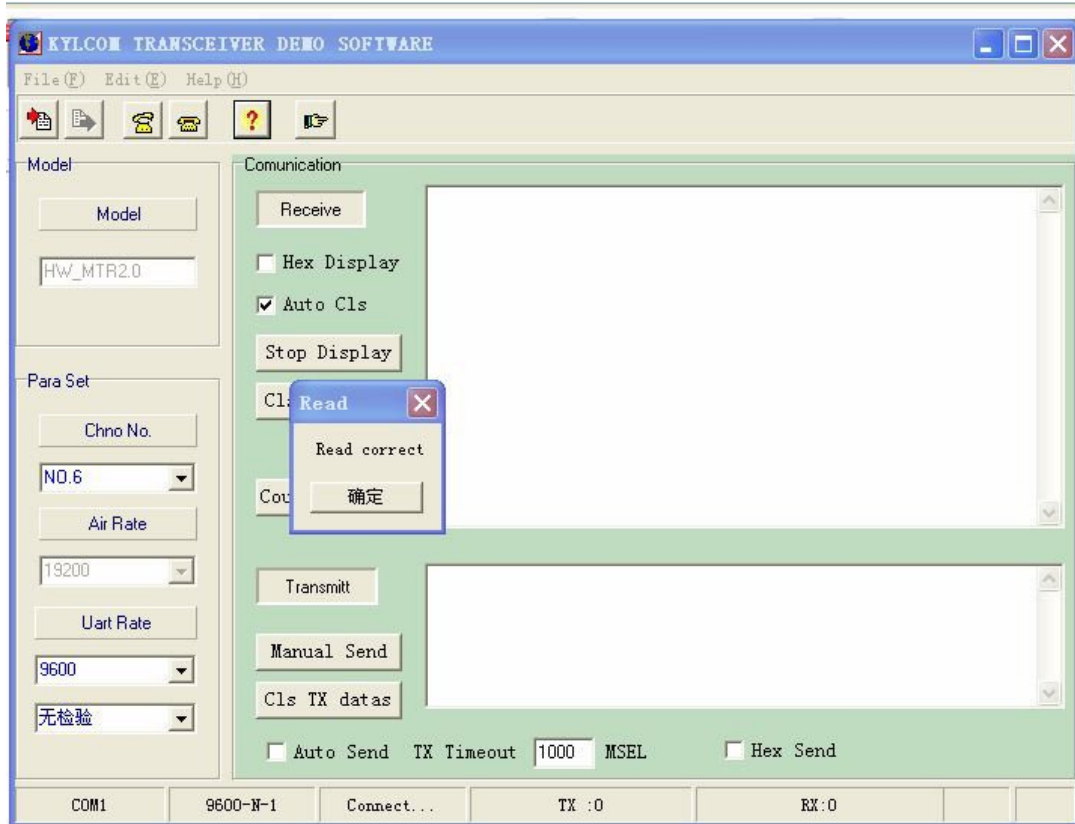

If you want to change some technical parameter, you need do as follows.

. User can change the parameter such as channel and interface rate and Parity mode according to actual demand through the button of the left window. After writing the parameters in the left catalogue, click the “write para”, then will show “write correct”. So you have finished the process for changing technical parameter.

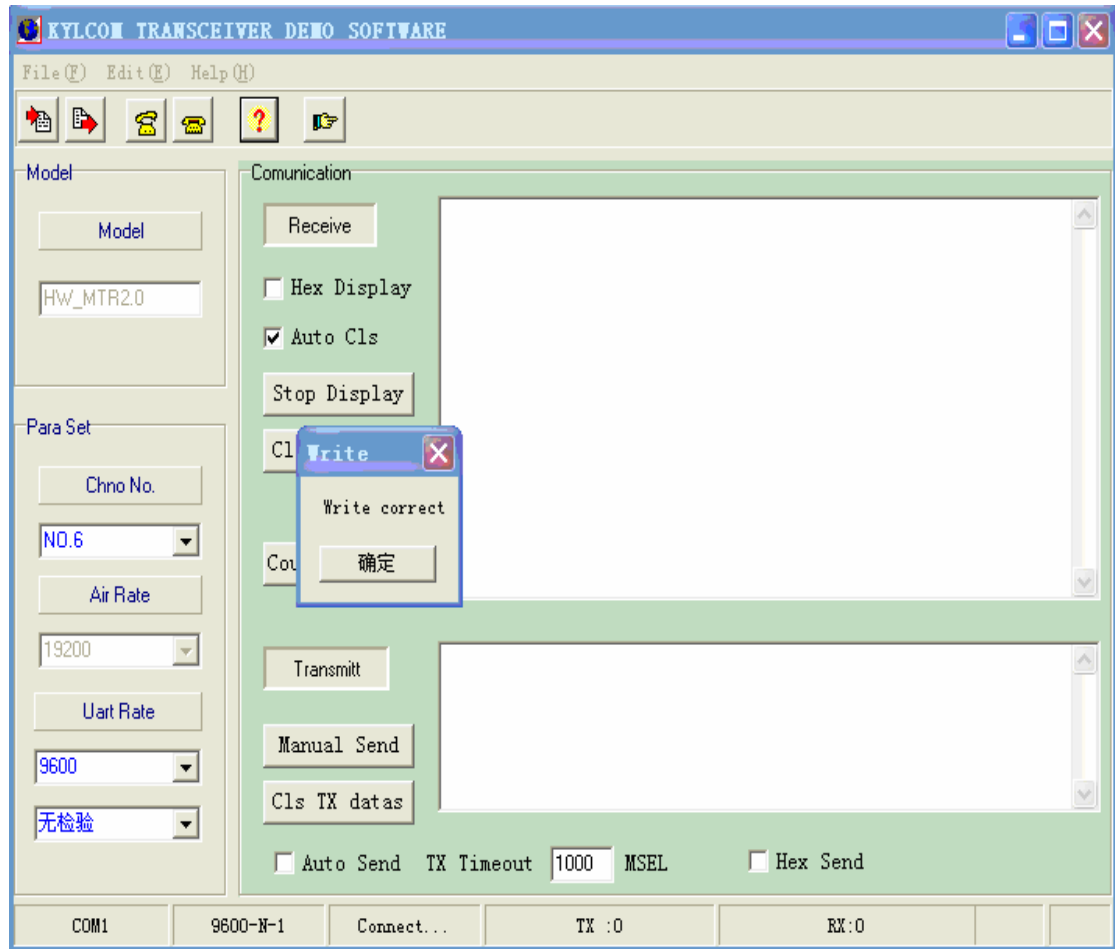

Note: The RF data rate(Air Rate) can not be set by user, it is confirmed when placing orders and set before delivery. So please confirm the RF data rate when placing the order.

5. Installation dimension:

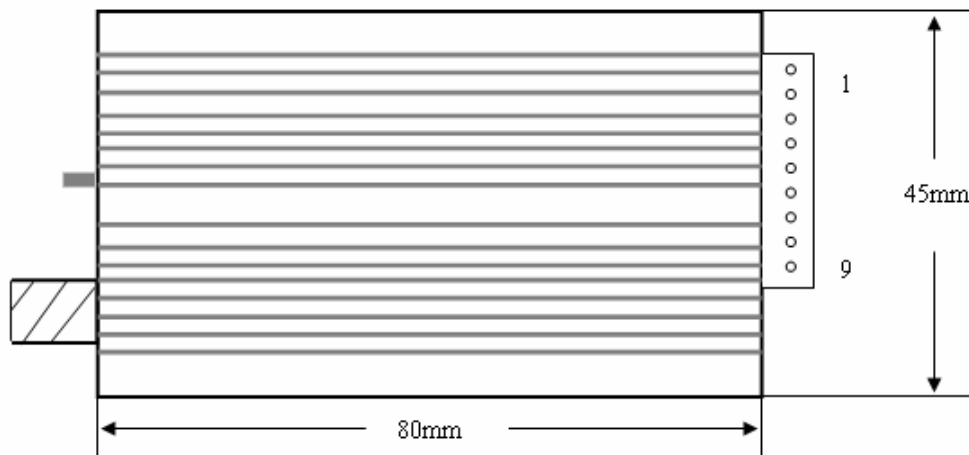

6. The Function-indicator light

- a. The LED indicator light will glitter red for 0.5S once after switched on.
- b. The LED indicator light will glitter green continually while receiving data from air.
- c. The LED indicator light will glitter red continuously when transmitting data into air after receiving from COM.
- d. If the module enables the sleep function, LED indicator light is always dark.

7. Supported protocol and Transmit capability

KYL-300L standard transceivers offer transparent protocol to support various applications and protocols of users. If the user needs to decrease his cost or ease the workload of terminal CPU, we can add other specific functions based on the transparent protocol, such as addressing, data acquisition, command interpretation, etc.

8. Sleep function instruction:

Due to reducing more consumption, KYL-300L transceivers support Sleep function. In sleep mode, the current consumption is less than 20uA.

a. How to use the Sleep function:

The Pin8 ‘SLP’ in JP1 is the signal of sleep control. In high power level, transceiver stays in working mode. In low power level (<0.5V), transceiver stays in sleep mode. The SLP signal can convert transceiver from working to sleep mode in 1ms after falling edge. If the Sleep signal arrives when the transceiver is transmitting data, the module will enter sleep mode after finishing transmission. From sleep mode to working, it takes the transceiver 1ms after rising edge.

To disable the opened sleep function of KYL-300L, the SLP (SLEEP) pin should be definitely connected with 0 or ground.

b. Attentions about use of sleep function:

When the sleep function enabled, any supply glitches, such as switch dithering, fire striking or quick switching on and off, could cause the transceiver to be switched to the wrong sleep mode.

After switching on, users can avoid this error by making a compulsive restoration once after the CPU delays 100ms.

Sleep Timing Diagram:

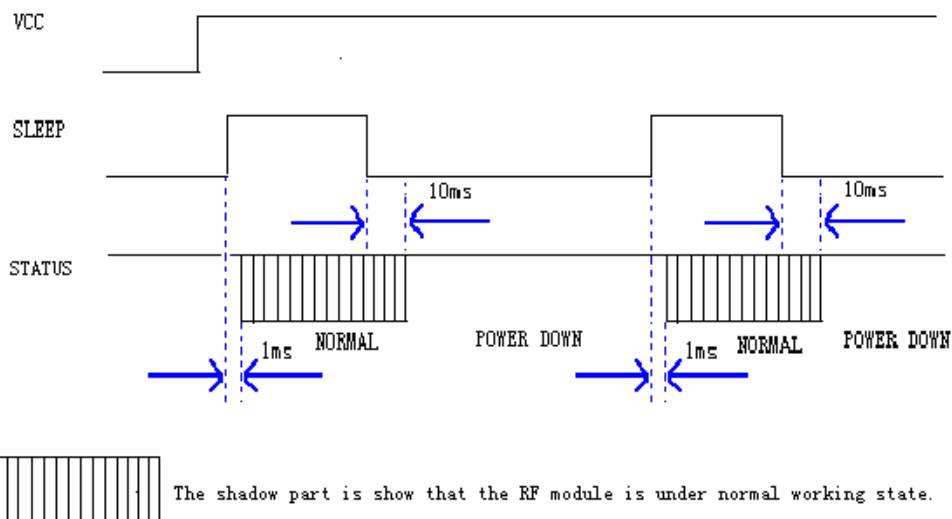

8. The attentions of data transmission

a. The delay time (t_c) of conversion between transmitting and receiving is less than 1ms.

Timing diagram:

KYL SERIES

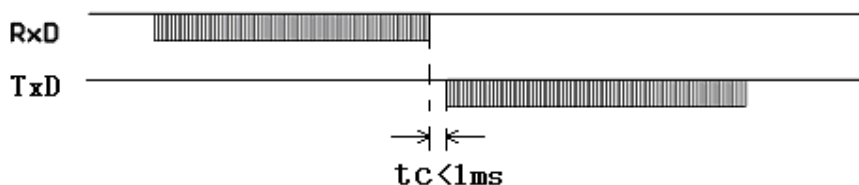

b. The delay time of transceivers between the first bit sent by TxD to the first bit received by RxD.

Due to a data processing will be made on user's data by KYL-300L transceiver using FEC (Forward Error Correction) or other correction algorithm, when RxD of a KYL-300L transceiver 'A' receives the data, then transmits it, the other one transceiver 'B' will have a delay (t_s) to receive and transmit by TxD. Different RF data rate causes different delay time. Please see the specific delay time below:

RF Date Rate (bps)	Delay Ts(mS)	RF Date Rate (bps)	Delay Ts(mS)
1200	90	9600	16
2400	48	19200	10
4800	30		

Timing diagram:

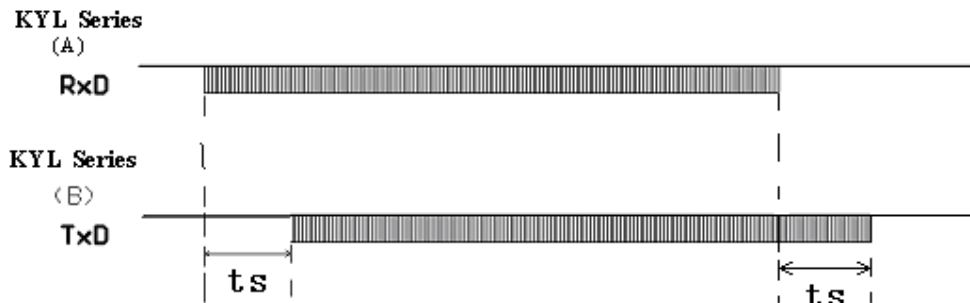

c. Error dealing procedure:

To enhance the reliability and stability of user's systems, a verify bit or a Cyclic Redundancy Check (CRC) mode is highly recommended to resent the wrong information while using KYL-300L modules.

d. Large-number data transmission

In theory, when the interface data rate is faster than the RF data rate, KYL-300L transceivers can sent unlimited-long data package, but any long packages more than 120B are not recommended. The length of each package should be between 60~100B. We also recommend user to resent the wrong information using Automatic Error Request Equipment (ARQ).

The analyzing as below:

What if the actual transmission BER (Bit Error Rate) is 10^{-4} , 1 packet with 1KB data, which is about 10-thousand bits, is sent, theoretically, at least 1 bit will be received wrongly, then the 1KB information will never be received correctly.

But if we package the data into 10 packets with 100B for each, when all 10 packets are sent, there will be only 1 packet wrong according to this probability. After that, resend this wrong packet using ARQ mode. So by resending one more packet and the efficiency rate is reduced 10%, all data will be absolutely received correctly.

10. Antenna configuration:

Many appropriate antennas for low power RF modules are selected for meeting different user antenna configurations. Please ask our Sales office for further information about the antenna's dimension and performance.

a. Helical SMA antennas

KYL-ANT-433-10-SMA: 100mm helical SMA antennas with high gain and low cost, reach a long distance.



KYL-ANT-433-3-SMA: 28mm SMA helical antenna with magnetic core, small size, beautiful appearance (like the mobile phone antenna)



KYL-ANT-433-10-ZSMA: 100mm SMA helical antenna with folding joint, easy for adjusting the direction and fixing.



b. Magnetic vehicle antenna

KYL-ANT-O433S-300H1.5-SMA: include magnetic antenna base, suitable for equipment with metal shell, easy for fixing, effective to enhance the transmission distance.



More kinds of antenna, please browse our website:
http://www.kylcom.com/Products_list_en.asp?classid=163

If the user has special demands on antennas, we can design and produce for them specially.

V. Networking Application of KYL-300L

The communication channel of KYL-300L is half duplex, which is most suitable for the communication mode of point to multi-point. Under this mode, one master station must be set, and all of the rest are slave stations. A unique address is given to each station. The coordination of communication is controlled by master station that uses data frames containing address code to transmit data or command. Slave station will receive all of the data and command and compare the received address code with local address code. If they are different, the data

will be deserted without any response. If those address codes are the same, it means the data is sent to the local. Slave station will make different responses according to the transmitted data or command and send back the data of response. All these jobs must be performed by upper protocol, and it is assured that there is only one transmitter-receiver in the state of transmission in the communication network at any instant moment so as to avoid the cross-interference.

KYL-300L can also be used for point-to-point communication with easier operation. For the programming of serial port, all you have to do is to remember that its communication mode is semi duplex while always observing the time sequence of come-and-go for receiving and transmitting.

VI. Technical specification of KYL-300L

- * Modulation mode: GFSK/FSK
- * Working frequency: 400MHz~470MHz, 868MHz, 915MHz;
- * Power supply: DC 5V (7.5V~12V informed when placing the order);
- * RF power: $\leq 500\text{mW}$, 600mW~1W is available;
- * RF data rate: 1200/2400/4800/9600/19200bps (Set before delivery);
- * Receive current: $<28\text{mA}$ (TTL connect);
- * Receive sensitivity: -123dBm (1200bps); -118dBm (9600bps);
- * Transmitting current: $<350\text{mA}$;
- * Sleep current: $<20\mu\text{A}$;
- * Interface port: RS232/RS485/TTL/USB
- * Interface data format: 8E1/8N1/8O1;
- * Working humidity: 10%~90% relative humidity without condensation;
- * Working temperature: $-35^{\circ}\text{C}\sim+75^{\circ}\text{C}$ (industrial)
- * RF Line-of-sight Range: 2000m(BER=10-5@9600bps);
3000m(BER=10-5@1200bps) ;
- * Size: 80mm*45mm*19mm (without antenna port).

VII. Description of type

