



LA1867NM

Car Radio Single-Chip Tuner System

Overview

The LA1867M is a high-performance multifunction (FM-IF, noise canceller, MPX and MRC) single-chip tuner IC for use in car radios. High-quality tuners with superlative cost-performance characteristics can be constructed easily using this IC.

Functions

- FM-IF
- Noise canceller
- MPX
- MRC (multipath noise reduction circuit)

Features

- Forms a high-performance FM tuner when combined with the Sanyo LA1193 FM front-end IC.
- Multiple functions, MRC circuit, dual diversity, and RDS handling
- High performance, high sensitivity and high stability (excellent temperature characteristics)
- High audio quality and noise reduction according to the reception conditions.
- Miniaturization of the required external capacitors (electrolytic capacitors no longer required)
- Easy adjustment (The SD, muting and SNC circuits are separated.)

Package Dimensions

unit: mm

3148-QIP44MA

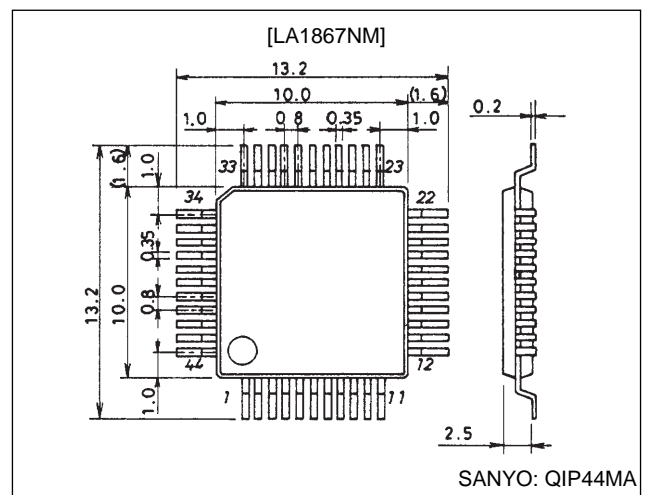

Specifications

Maximum Ratings at $T_a = 25^\circ\text{C}$

Parameter	Symbol	Conditions	Rating	Unit
Maximum supply voltage	$V_{CC \text{ max}}$	Pins 4 and 31	9.2	V
Allowable power dissipation	$P_{d \text{ max}}$		740	mW
Operating temperature	T_{opr}		-40 to +85	$^\circ\text{C}$
Storage temperature	T_{stg}		-40 to +150	$^\circ\text{C}$

Operating Conditions at $T_a = 25^\circ\text{C}$

Parameter	Symbol	Conditions	Rating	Unit
Recommended supply voltage	V_{CC}	Pins 4 and 31	8.0	V
	$V_{CC \text{ ST/SD}}$	Pins 29 and 44	5.0	V
Operating supply voltage range	$V_{CC \text{ OP}}$		7.0 to 9.0	V

SANYO Electric Co., Ltd. Semiconductor Business Headquarters

TOKYO OFFICE Tokyo Bldg., 1-10, 1 Chome, Ueno, Taito-ku, TOKYO, 110-8534 JAPAN

LA1867NM

Operating Characteristics at Ta = 25°C, V_{CC} = 8.5 V (Note that these measurements are made using the IC-51-044-464 IC socket manufactured by Yamaichi Electric Works, Ltd.)

Parameter	Symbol	Conditions	Rating			Unit
			min	typ	max	
[FM BLOCK]						
Quiescent current	I _{CCO-FM}	No input (I ₄ + I ₃₁)	40	55	70	mA
Demodulator output	V _{O-FM}	10.7 MHz, 100 dBμ, 1 kHz, 100% mod, pin 7 output	175	260	350	mVrms
Channel balance	C _B	10.7 MHz, 100 dBμ, 1 kHz, 100% mod, the ratio of pin 7 to pin 8, Referenced to pin 7.	-1.0	0	+1.0	dB
Total harmonic distortion	THD _{-FMmono}	10.7 MHz, 100 dBμ, 1 kHz, 100% mod, pin 7		0.2	1.0	%
Signal-to-noise ratio (IF)	S/N _{-FMIF}	10.7 MHz, 100 dBμ, 1 kHz, 100% mod, pin 7	73	80		dB
AM suppression ration (IF)	AMRIF	10.7 MHz, 100 dBμ 1 kHz, fm = 1 kHz, Pin 7 when the AM modulation is 30%	57	70		dB
Muting attenuation	Att-1	10.7 MHz, 100 dBμ, 1 k Hz, the pin 7 attenuation when V ₂₂ goes from 0 to 1 V	20	25	30	dB
	Att-2	10.7 MHz, 100 dBμ, 1 k Hz, the pin 7 attenuation when V ₂₂ goes from 0 to 2 V	28	33	38	dB
Channel separation	Separation	10.7 MHz, 100 dBμ, L + R = 90%, pilot = 10%, the pin 7 output ratio	30	40		dB
Stereo on level	ST _{-ON}	The pilot modulation level such that V ₄₄ becomes less than 0.5 V*	1.5	2.9	5.0	%
Stereo off level	ST _{-OFF}	The pilot modulation level such that V ₄₄ becomes greater than 3.5 V*	0.8	1.9		%
Total harmonic distortion	THD _{-MainL}	10.7 MHz, 100 dBμ, L + R = 90%, pilot = 10%, pin 7		0.3	1.0	%
Pilot cancellation	P _{CAN}	10.7 MHz, 100 dBμ, pilot = 10%, pin 7 signal/PILOT-LEVEL leakage, DIN-audio filter	20	35		dB
SNC output voltage	V _{O-SUB}	10.7 MHz, 100 dBμ, L - R = 90%, pilot = 10%, V ₁₃ = 0.1 V, pin 7		3	10	mVrms
SNC output attenuation	Att _{SNC}	10.7 MHz, 100 dBμ, L - R = 90%, pilot = 10%, V ₁₃ = 3 V to 0.6 V, pin 7	2	6	10	dB
HCC output attenuation	Att _{HCC-1}	10.7 MHz, 100 dBμ, 10 kHz, L + R = 90 %, pilot = 10%, V ₁₄ = 3 V to 0.6 V, pin 7	2	6	10	dB
	Att _{HCC-2}	10.7 MHz, 100 dBμ, 10 kHz, L + R = 90 %, pilot = 10%, V ₁₄ = 3 V to 0.1 V, pin 7	6	10	14	dB
Input limiting voltage	V _{i-lim}	10.7 MHz, 100dBμ, 100% mod, IF input such that the input reference output is down by -3 dB, when the soft muting function is operating	33	42	51	dBμ
Muting sensitivity	V _{i-Mute}	The IF unmodulated input level when V ₂₃ is 2 V.	32	40	48	dBμ
SD sensitivity	SD _{sen}	The unmodulated IF input such that the SD pin voltage (V ₂₉) becomes 3.5 V or higher.	64	74	84	dBμ
IF counter buffer output	V _{IFBUFF-FM}	10.7 MHz, 100 dBμ, unmodulated, the pin 19 output	160	230	320	mVrms
AM output	V _{O-AM}	The pin 7 output in AM mode (AC ₂ = 300 mV rms, 1 kHz, the pin 20 input)	234	330	466	mVrms

Note: * Unless otherwise specified, with an IHF-BPF/T200 inserted in the pin 7 and 8 MPX output circuit.

Continued on next page.

LA1867NM

Continued from preceding page.

Parameter	Symbol	Conditions	Rating			Unit
			min	typ	max	
[FM BLOCK]						
Signal meter output	V_{SMFM-1}	No input, pin 32 DC output, non-mod, SW-2 open	0.0	0.1	0.3	V
	V_{SMFM-2}	50 dB μ , pin 32 DC output, non-mod, SW-2 open	1.0	2.1	3.3	V
	V_{SMFM-3}	70 dB μ , pin 32 DC output, non-mod, SW-2 open	2.3	3.5	5.3	V
	V_{SMFM-4}	100 dB μ , pin 32 DC output, non-mod, SW-2 open	4.7	6.0	6.7	V
Muting bandwidth	BW-Mute	100 dB μ , The bandwidth when $V_{23} = 2$ V, non-mod	110	190	290	kHz
Muting drive output	$V_{Mute-100}$	100 dB μ , pin 23 DC output, non-mod	0.00	0.03	0.20	V
[N.C BLOCK] Noise Canceller Input (pin 20), PG1						
Gate time	t_{GATE1}	$f = 1$ kHz, 1 μ s, with a 100 mV p-o pulse input, the time for V_{40} to become 1 V or higher	35	55	75	μ s
	t_{GATE2}	$f = 1$ kHz, 1 μ s, with a 100 mV p-o pulse input, with the MRC pin 15 input = 1 kHz, 30 mV rms	10	25	40	μ s
Noise sensitivity	S_N	With a 1 kHz signal such that the noise canceller operation is on, the 1 μ s pulse input level, measure pin 20.		50	75	mVp-o
[Multipath suppression circuit] MRC Input (AC1)						
MRC output	V_{MRC}	$V_{18} = 2$ V, 1 kHz, 5 mV rms, the pin 12 voltage when there is a pin 15 input	1.75	1.85	1.95	V
MRC operating level	MRC-ON	$V_{18} = 2$ V, the pin 15 input level such that V_{12} becomes 1.75 V		15	30	mVrms

Block Functions

1. FM-IF

- IF-limiter amplifier
- S-meter outputs (three systems)
- Quadrature detector
- AF preamplifier
- AFC output
- Muting circuit (band mute, weak input mute, soft mute)
- Control pins (SD, muting attenuation, soft mute on level)
- SD output
- IF counter buffer output
- S-meter output shifter

2. Noise canceller

- Built-in high-pass filter
- Built-in low-pass filter delay circuit
- Noise AGC
- Pilot signal compensation circuit
- Noise reduction setting pin
- Noise canceller off in AM mode function
- High-pass filter "fc" control pin

3. MPX

- Nonadjusting VCO (912 kHz)
- Level-following type pilot cancelation circuit
- SNC
- FM HCC
- Stereo/mono display output
- Built-in anti-birdie stereo decoder
- Automatic stereo/mono switching

4. MRC

- DC level shifter circuit
- Noise amplifier
- Noise detection circuit
- Time constant control circuit

Block Features

1. FM-IF

- The development of a high performance S-meter circuit has simplified all types of control.
 - High linearity S-meter circuit (6-stage detection type)
 - High quality S-meter (superlative temperature characteristics)
- High quality design
 - Design that emphasizes temperature characteristics
 - S-meter, SD sensitivity, -3 dB L.S., etc.
- Improved active characteristics
 - Muting circuit time constant control (Since the attack and recovery time can be set independently, the audio quality under multipath conditions can be improved.)
 - Three built-in S-meter circuits

Soft mute/H _{CC} time constants	}	Application design is eased since these can all be set independently.
SD time constants		
SNC time constants		

2. Noise canceller

- Noise canceller error prevention when a narrow band (150 kHz) ceramic filter is used
- A new noise canceller system was developed.
 - Reduced noise canceller errors during overmodulated signal reception.
 - Reduced noise canceller errors under continuous noise conditions.
- Miniaturization of the required external capacitors

3. MPX

- Miniaturization of the required external components (nonadjusting 912 kHz VCO)
- Improved basic performance
 - Pilot cancelation level (30 dB typ.)
 - No variation in mono output level due to separation adjustment (subcarrier output level adjustment type separation adjustment)
 - A new SNC curve was developed.
 - Built-in anti-birdie filters (114 kHz and 190 kHz)
 - Improved high region separation characteristics
 - Improved stereo signal-to-noise ratio

4. MRC

- Controls the SNC and HCC circuit control signals by detecting the field strength (S-meter) and multipath noise.

LA1867NM

Block Diagram and Peripheral Circuits

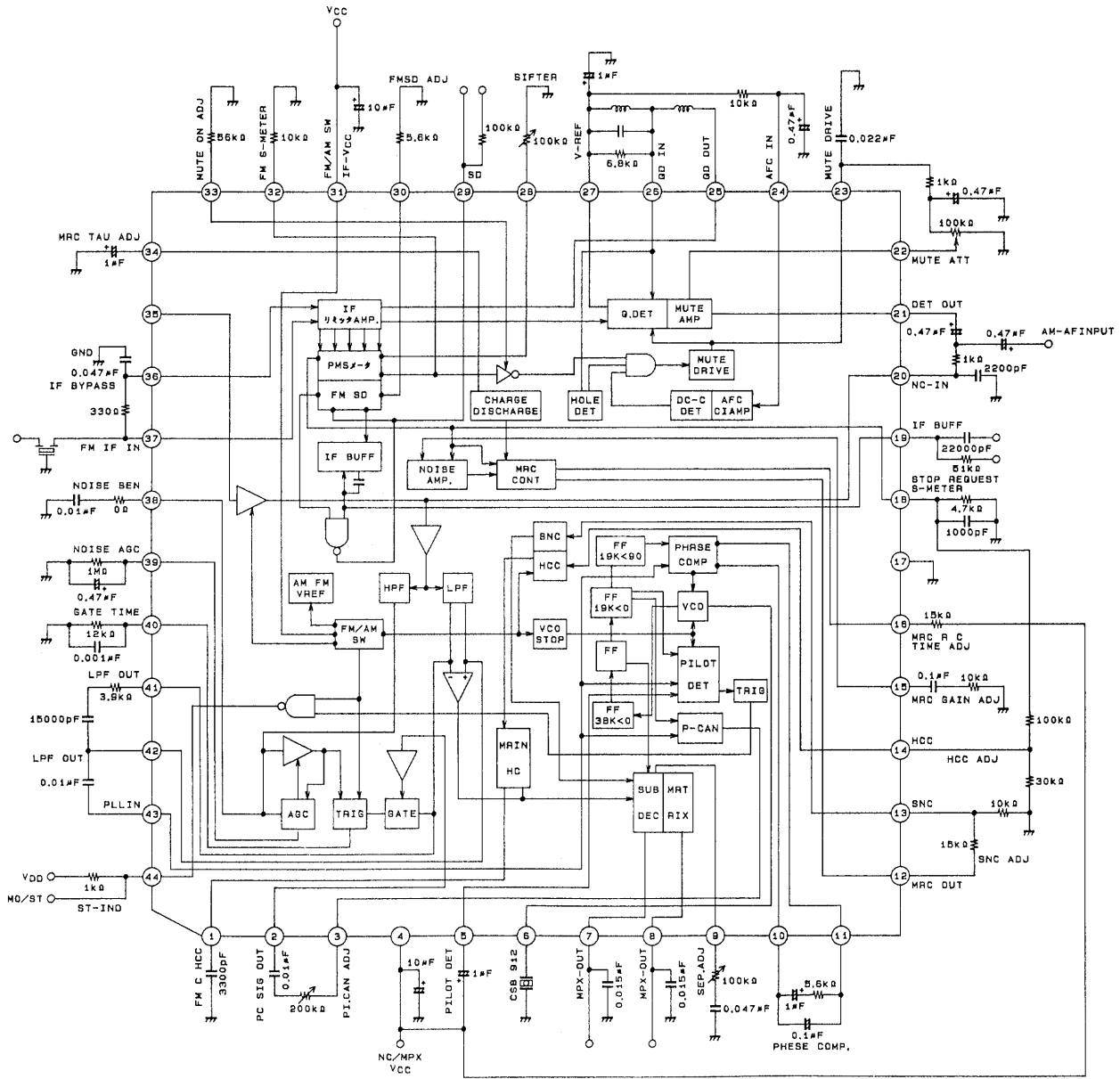

A04478

LA1867NM

Pin Functions

FM-IF Block

Unit (resistance:Ω, capacitance:F)

Pin	Function	Equivalent internal circuit	Note
18 32 30 28	S-meter output for MRC and SNC S-meter output for muting drive and HCC S-meter output for SD S-meter output shift control pin		<p>Constant current drive type</p> <p>The slope can be changed by changing the value of the S-meter output resistance.</p> <p>The field strength can be shifted in the positive or negative direction with an external resistor on pin 28 without changing the S-meter slope.</p>
20 21	Noise canceller input FM detector output		<p>Noise canceller input</p> <p>The input impedance is 50 kΩ.</p> <p>FM detector output</p> <p>Low impedance in FM mode</p>
30	FM SD Adj		<p>Pin 30</p> <p>The comparison voltage is determined by the external resistor.</p> <p>Pin 30 is the S-meter output, and SD turns on when it exceeds the internal supply voltage.</p>

Continued on next page.

LA1867NM

Continued from preceding page.

Unit (resistance:Ω, capacitance:F)

Pin	Function	Equivalent internal circuit	Note
37 36	FM IF IN IF BYPASS		Limited amplifier input Select the capacitor grounding point carefully.
23 22	Mute drive output Mute input		<p>① The muting time constants from the external CR circuit are determined as follows. Attack time $T_A = R_1 \times C_2$ Release time $T_R = R_2 \times C_2$</p> <p>② Noise convergence adjustment Divide the V_{23} voltage by R_2 when there is no input at the antenna input, and input that voltage to pin 22. Noise convergence will be maximum when $V_{22} = 2\text{ V}$. The variation range is 5 to 35 dB, taking the 1 kHz 22.5 kHz dev output as the reference.</p> <p>③ Muting off function The muting is turned off when pin 22 is shorted to ground.</p>
33	FM mute ON Adj		The muting on level is adjusted by changing the external resistance R.

Continued on next page.

LA1867NM

Continued from preceding page.

Unit (resistance:Ω, capacitance:F)

Pin	Function	Equivalent internal circuit	Note
24 25 26 27	AFC QD OUT QD IN V _{REF}		<ul style="list-style-type: none"> • R₁ is the resistor that determines the band muting bandwidth. Increasing R₁ reduces the bandwidth. Decreasing R₁ increases the bandwidth. • Null voltage When tuned, the voltage between pins 24 and 27 will be 0 V. $V_{24} - V_{27} = 0 \text{ V}$ The band muting is turned on when $V_{24} - V_{27} \geq 0.7 \text{ V}$.
29 30	SD pin SD sensitivity adjustment pin		<p>The SD output for the pin 30 SD. R determines the SD sensitivity.</p> <p>Pin 23 is coupled to the muting drive output. SD operates when the switch is off.</p>
19	IF counter buffer Seek/stop switch		<p>This pin is used for both the IF counter buffer (AC output) and the seek/stop switch (DC input).</p> <p>It is not coupled to the SD output.</p> <p>The IF buffer is turned on and off by the pin 19 DC bias level.</p> <p>Pin 19: high → buffer on, low → buffer off.</p>

LA1867NM

MPX Block

Unit (resistance:Ω, capacitance:F)

Pin	Function	Equivalent internal circuit	Note
5	Pilot detector		The IC is forced to mono if a 1 MΩ resistor is inserted between pin 5 and V _{CC} .
14	H _{CC} control input pin		H _{CC} is off in AM mode.
13	SNC control input pin		Controls the sub output with an input of between 0 and 1 V.

Continued on next page.

LA1867NM

Continued from preceding page.

Unit (resistance:Ω, capacitance:F)

Pin	Function	Equivalent internal circuit	Note
10 11	PHASE COMP.		
9	Separator adjustment pin		<p>The sub decoder input level is adjusted with a trimmer. (The output level in mono and main modes does not change.)</p>
6	VCO		<p>The oscillator frequency is 912 kHz.</p>

Continued on next page.

LA1867NM

Continued from preceding page.

Unit (resistance:Ω, capacitance:F)

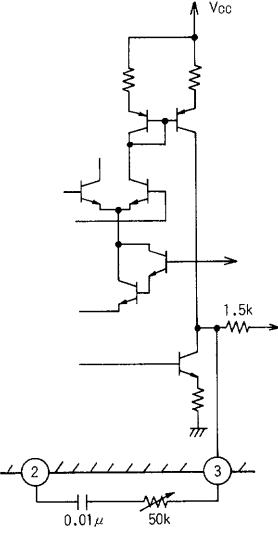
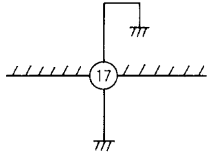
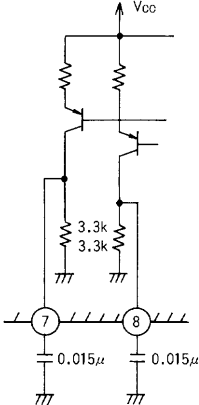
Pin	Function	Equivalent internal circuit	Note
3	Pilot cancellation signal output		Pin 3 is the pilot cancellation signal output.
17	GND		GND
7 8	MPX out (left) MPX out (right)		

LA1867NM

MPX Block Applications

Unit (resistance:Ω, capacitance:F)

Pin	Function	Equivalent internal circuit	Note
43	Pilot input		Pin 43 is the PLL circuit signal input.
1	HCC capacitor		The HCC frequency characteristics are determined by the capacitor connected at this pin.

NC Block

Pin	Function	Equivalent internal circuit	Note
2	Pilot cancellation signal input		The pilot signal level must be adjusted since it varies with manufacturing variations in the IF output level and other parameters.

Continued on next page.

LA1867NM

Continued from preceding page.

Unit (resistance:Ω, capacitance:F)

Pin	Function	Equivalent internal circuit	Note
40	Time constant connection for the monostable multivibrator		This time constant sets the gate time to 40 μs. The noise rejection ratio increases with the gate time. However, caution is required since multipath and the distortion sensitivity for overmodulated signals are degraded.
41 42 43	Memory circuit pins		The memory circuit used when the noise canceller operates

NC Block Applications

Pin	Function	Equivalent internal circuit	Note
20	Noise killer input		The input impedance is about 50 kΩ.

Continued on next page.

LA1867NM

Continued from preceding page.

Unit (resistance:Ω, capacitance:F)

Pin	Function	Equivalent internal circuit	Note
38 39	Noise AGC sensitivity adjustment pins		Pin 38 is the noise sensitivity setting pin. First set the medium field (about 50 dBμ) level, and then set the weak field (about 20 to 30 dBμ) with pin 39 (AGC adjustment).
35	HPF slope adjustment pin		The slope of the high-pass filter can be adjusted by changing the value of the resistor (R) connected between pin 35 and ground. If this adjustment is not needed, pin 35 can be left open.

MRC Block

Pin	Function	Equivalent internal circuit	Note
18	IF S-meter output and MRC DC input pin		S-meter output block MRC DC input block

Continued on next page.

LA1867NM

Continued from preceding page.

Unit (resistance:Ω, capacitance:F)

Pin	Function	Equivalent internal circuit	Note
12	MRC output pin		

MRC Block Applications

Pin	Function	Equivalent internal circuit	Note
15	MRC AC input pin	<p>Figure 1</p> <p>Figure 2</p>	<p>In methods in which the S-meter AC components are detected directly, the noise amplifier gain is determined by R_2 and the 30 kΩ internal resistance, as shown in Figure 1. A certain degree of filtering characteristics can be provided with capacitor C_1.</p> <p>In methods in which the S-meter high area components are detected, or the NC HDF noise output is detected, the noise amplifier gain is determined by R_2 and 30 kΩ as shown in Figure 2. Here, the frequency characteristics are determined by C_1.</p>
34	MRC control voltage time constant		
34 16	MRC control voltage time constant Time constant setting pin constant		<p>During discharge, the MRC detector time constant is determined by R_S (1 kΩ) and C_A. During charge, it is determined by I_C and C_A.</p> <p>Attack time = $C_A \times R_S$ (Stereo → mono)</p> <p>Recovery time = $C_A \times R_A$ (Mono → stereo)</p>

Usage Notes

1. AM/FM switching: Pin 31 (IF V_{CC})

This pin is shared with the IF V_{CC} . When the FM IF is operated, the IC automatically switches to FM mode. (Note that the switching reference voltage is 3.3 V.)

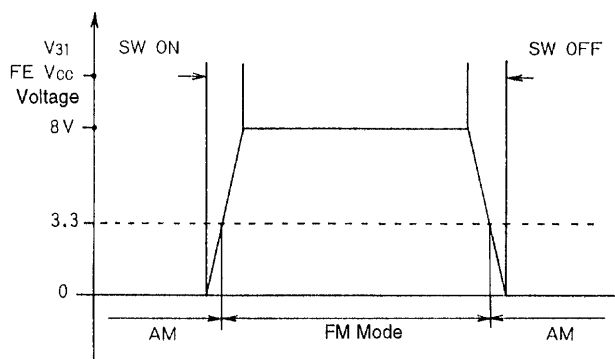

Pin V_{31}	Mode
8 V	FM
open	AM

Figure 1

2. FM SD and SD adjustment

The FM SD and the IF counter buffer operate with the elements shown below.

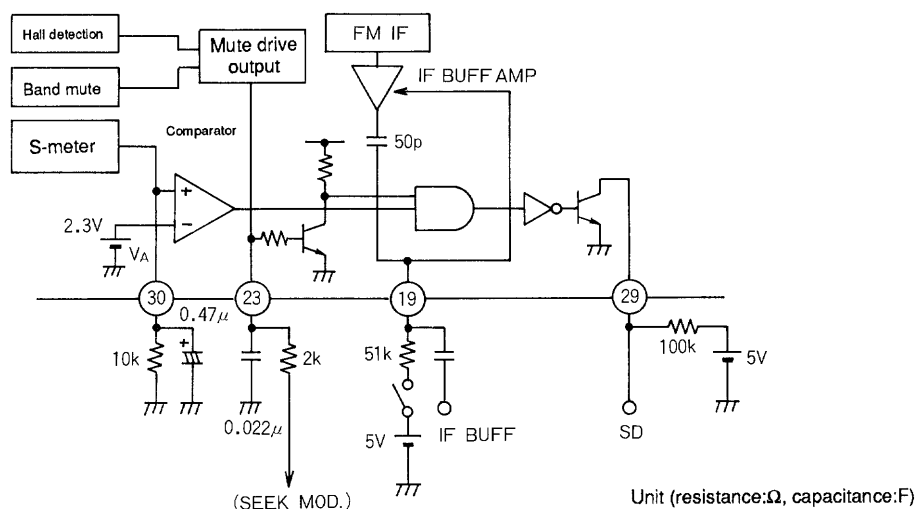

The following conditions are required for FM SD operation.

- $V_{30} > V_A$: The S-meter voltage must be higher than the regulator voltage.
- $V_{23} < 0.7 \text{ V } (V_{BE})$: The Hall detector and band mute must not operate.
- $V_{29} = \text{H}$: A high level must be applied to pin 29 through a 100 kΩ resistance.

The following condition is required for IF buffer operation.

- $V_{19} = \text{H}$: A high level must be applied to pin 19 through a 51 kΩ resistance.

LA1867NM

3. FM muting on: Pin 33 ($R_{33} = 100\text{ k}\Omega$)

The -3 dB limiting sensitivity can be changed by varying R_{33} .

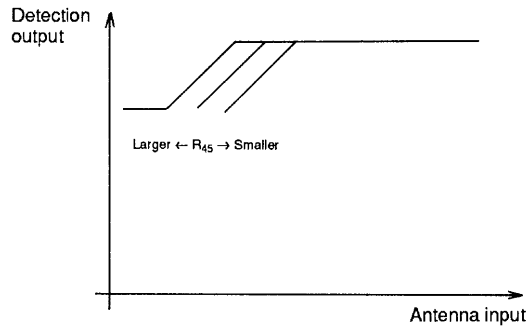

(Currently, R_{33} is $25\text{ k}\Omega$ to set the -3 dB limiting sensitivity to $8\text{ dB}\mu$.)

4. FM muting attenuation adjustment: Pin 22 (R_{22} is a 30 or $50\text{ k}\Omega$ variable resistor)

The pin 23 voltage is divided by the R_{22} variable resistor and input to pin 22. The no-input noise convergence is determined by value of the pin 22 voltage.

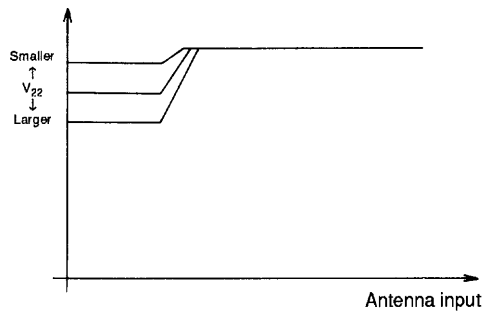

(The LA1867NM has a noise convergence design target of from 5 dB to 30 dB .)

5. Muting time constant

The LA1867NM allows the volume level to be changed gradually for field variations during weak field reception by setting the attack and recovery times for the soft mute function.

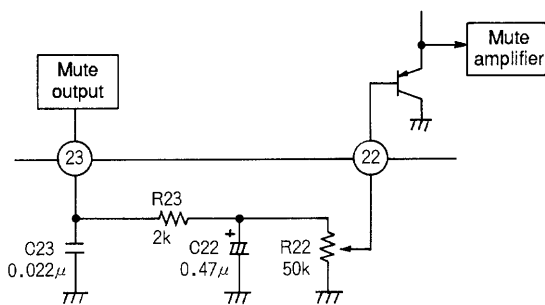

- ① Attack time setting
 $t_a = R_{23} * C_{22} = 940\ \mu\text{sec}$
- ② Recovery time setting
 $t_r = C_{22} * R_{23} = 23500\ \mu\text{sec}$

Unit (resistance: Ω , capacitance: F)

6. FM mute off function

The muting function is turned off if pin 22 is forcibly connected to ground.

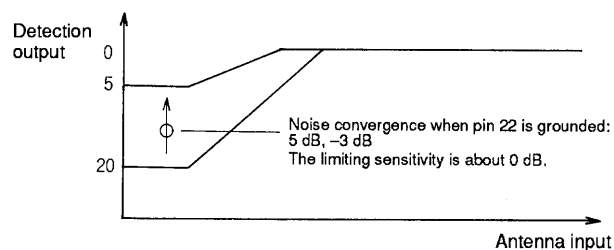

MPX Block

1. HCC (high-cut control frequency characteristics (pin 1))

During HCC control, the output signal frequency characteristics are determined by the capacitance of the external capacitor connected to pin 1.

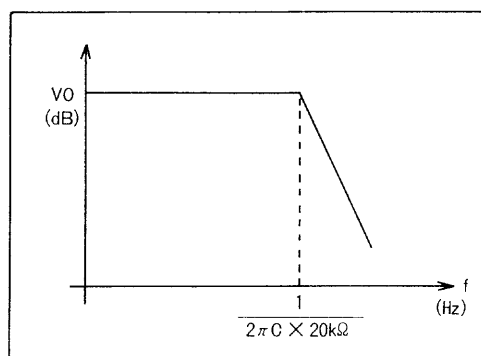
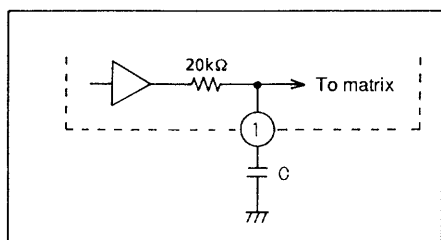

$$f_c = \frac{1}{2\pi \times C \times 20k\Omega} \text{ (Hz)}$$

2. Pilot cancellation adjustment (pins 2 and 3)

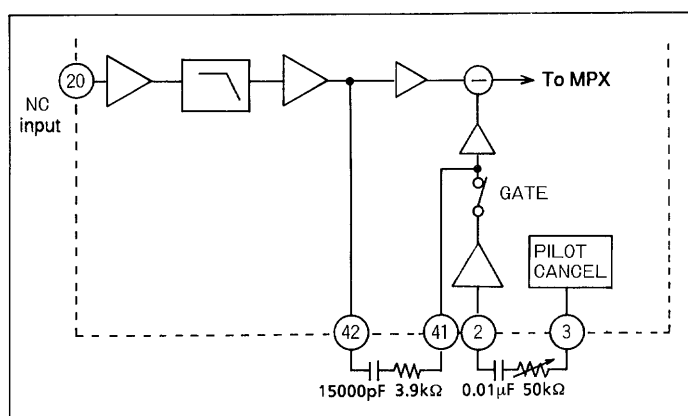

The pin 3 pilot cancellation waveform is a 19 kHz signal that does not include a third upper harmonic component, as shown in the figure above. Also, no capacitor is required between pin 3 and ground since this signal is in phase with the pilot signal. Good pilot cancellation characteristics can be acquired in the left and right channels by adjusting the variable resistor, since the signal does not include a third upper harmonic component.

3. Separation adjustment (pin 9)

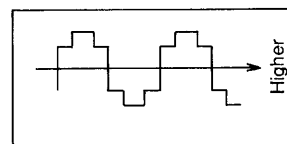
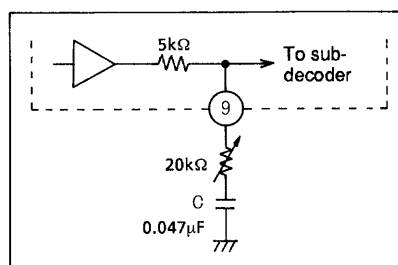

The separation is adjusted by varying the sub-decoder input level with the pin 9 variable resistor. Only the sub-decoder level changes when the variable resistor is changed; the mono (main) output level does not change. Also, the decoder high-band separation in the sub signal frequency band (23 to 53 kHz) will not be degraded if the external capacitor C's value is made sufficiently smaller than the variable resistor's impedance.

Notes on Using the Application Circuits

1. NC Block

- The input impedance of the noise canceller input is about 50 k Ω . Carefully consider the low area frequency characteristics when determining the value of the coupling capacitor. Note that when the value is 1 μ F in the application circuit, f_c will be about 3 Hz.
- Pins 38 and 39 are used to set the noise detection sensitivity and the noise AGC. The values of the external components can be determined more easily by first setting the medium field (antenna input levels of about 50 dB μ) with the noise sensitivity setting pin (pin 38), and then setting the weak field (antenna input levels of about 20 to 30 dB μ) with the AGC adjustment pin (pin 39). Care is required in determining these settings since while the AGC operation improves as the noise detection sensitivity is increased, inversely, the weak field sensitivity decreases.
- If noise is detected again during gating, since the monostable multivibrator will be reset, the gate time will change with the magnitude of the noise. Finally, set the gate time from the point noise is detected. When the circuit constants in the circuit connected to pin 40 are $C = 0.001 \mu$ F and $R = 12 \text{ k}\Omega$, the gate time will be about 10 μ s.

2. MRC Block

- The MRC (multipath rejection circuit) supports three techniques as shown in Figures 2, 3 and 4. Figure 2 shows the technique in which the S-meter AC component is detected directly. Figure 3 shows the technique in which the NC HPF noise is detected, and Figure 4 shows the technique in which multipath is detected using the S-meter high area components.

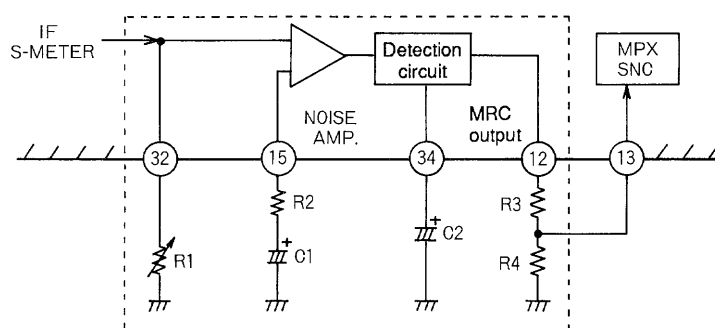

Figure 2 Multipath Circuit

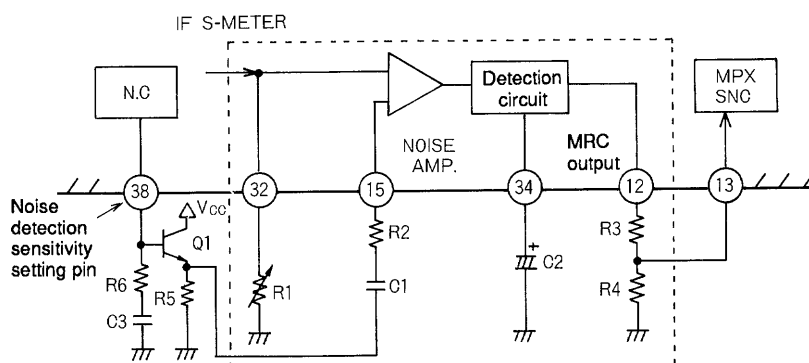

Figure 3 Application Circuit Using NC HPF Noise Detection

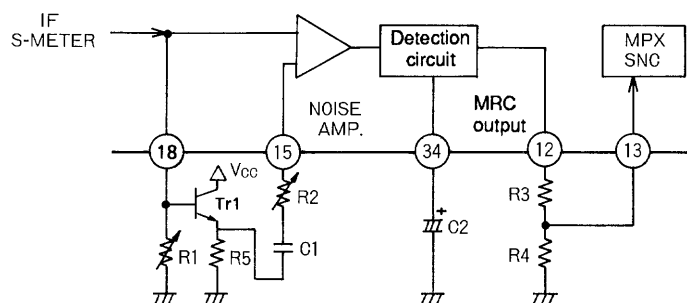

Figure 4 Application Circuit Using IF S-Meter High-Area Detection

- In the technique in which the S-meter AC component is detected directly the noise amplifier gain is determined by R_2 and the internal $30\text{ k}\Omega$ resistance as shown in Figure 5. A certain degree of filtering characteristics can be provided with capacitor C_1 .

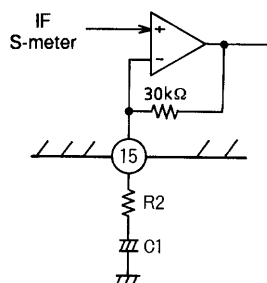

Figure 5

- In the technique of Figure 4, in which multipath is detected using the S-meter high area components, and In the technique of Figure 3, in which the NC HPF noise is detected, the noise amplifier gain is determined by R_2 and the internal $30\text{ k}\Omega$ resistance as shown in Figure 6. The frequency characteristics of the circuit are determined by the capacitor C_1 .

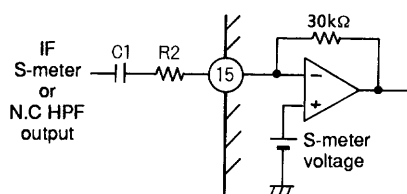

Figure 6

- The time constants with which the MRC controls the separation are determined by the internal 1 kΩ resistance and C₂ on discharge, and the 7 μA fixed current and C₂ on charge.

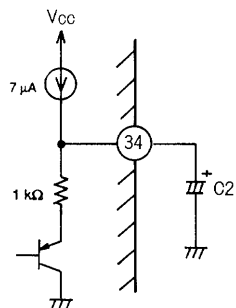

Figure 7

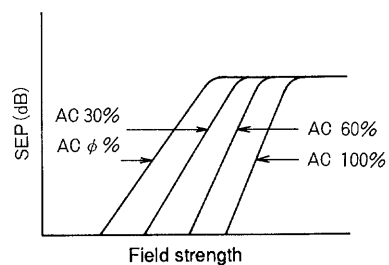
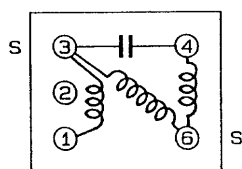

Figure 8

Coil Specifications

- Toko Electric Corporation Coils
7KLS M402AES-1298



A04886

6-4	4T
6-3	22 1/4T
3-1	65T
C	91 pF
Q	30

- Sumida Electric Coils
QU-7L SA-208

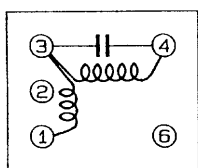

A04887

4-3	18 1/4T
3-1	70 1/4T
C	100 pF
Q	35

- Ceramic Oscillators

- Murata Mfg. Co., Ltd.
CSB912JF104

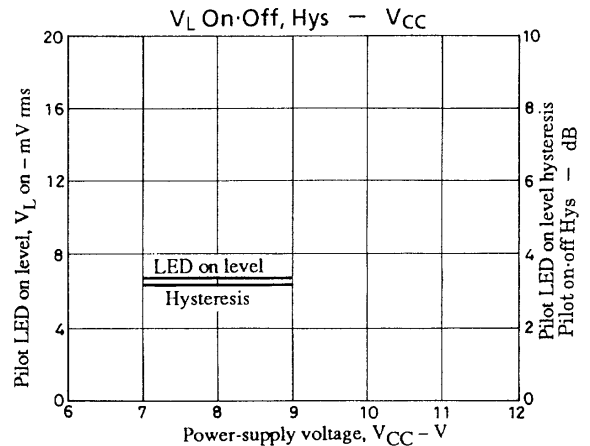
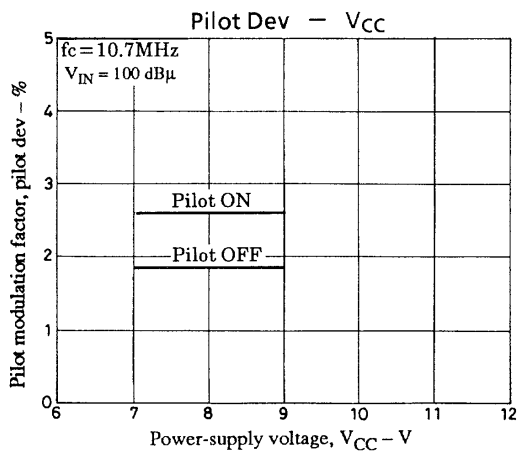
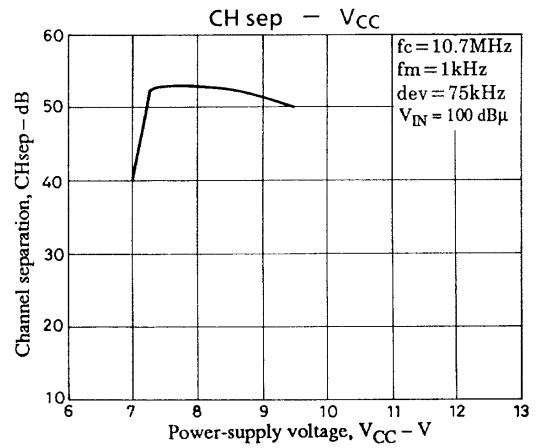
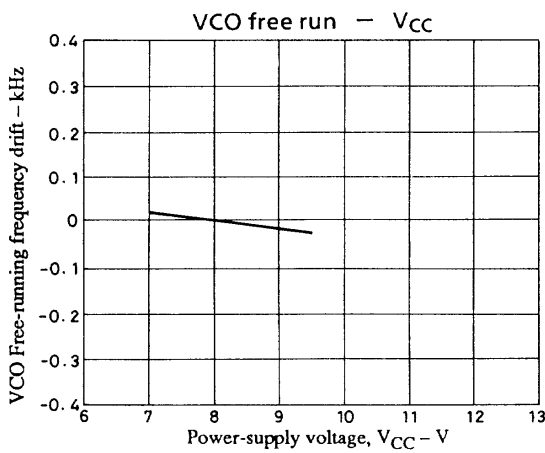
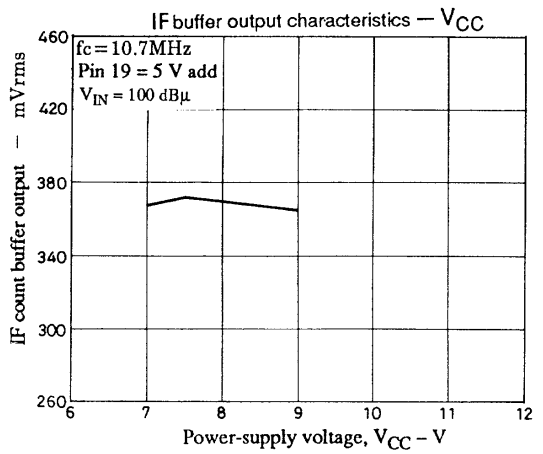
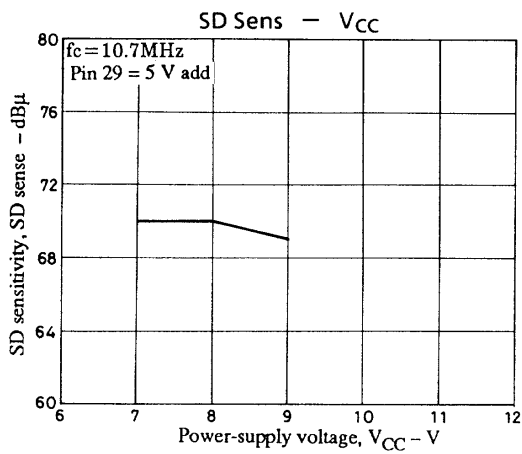
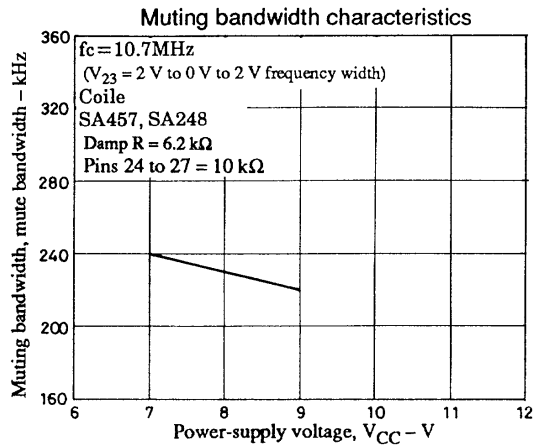
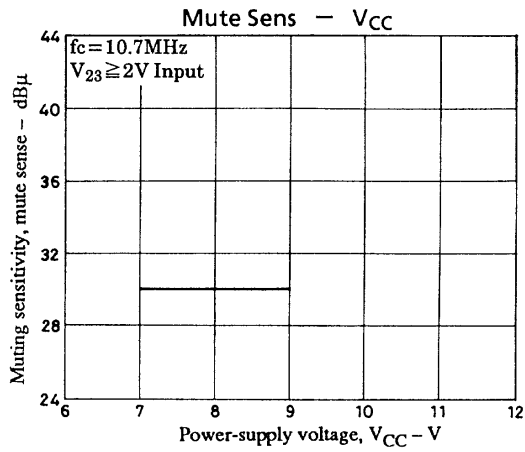

LA1867NM

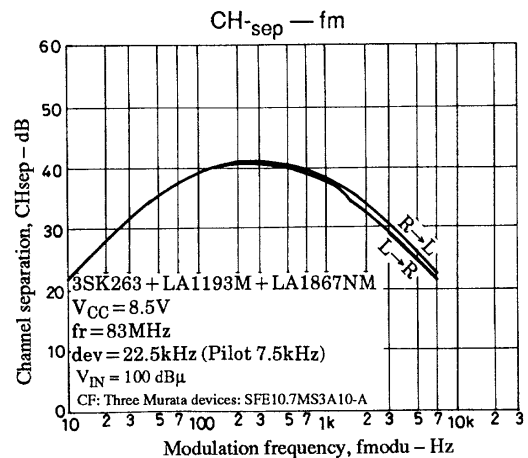
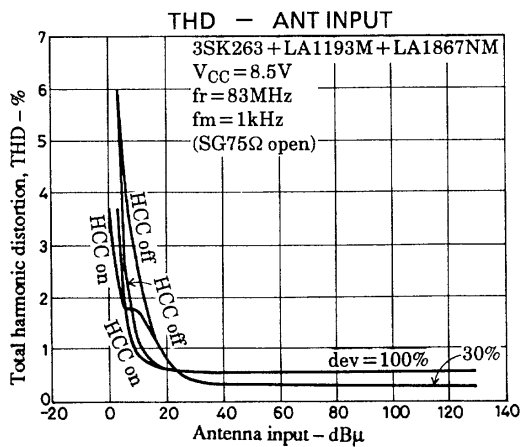
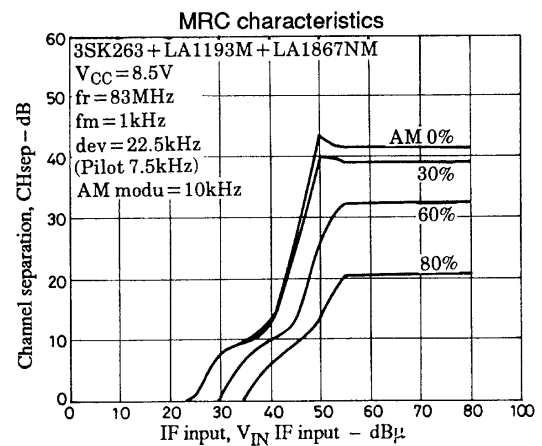
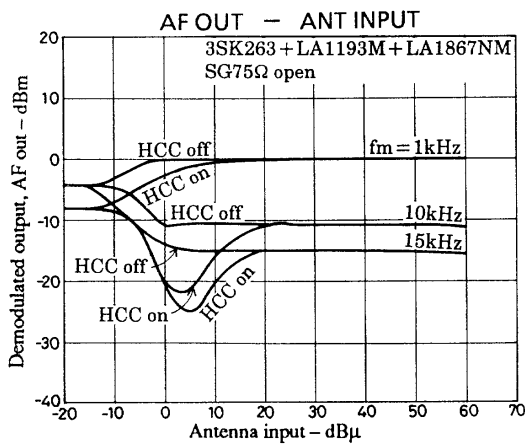
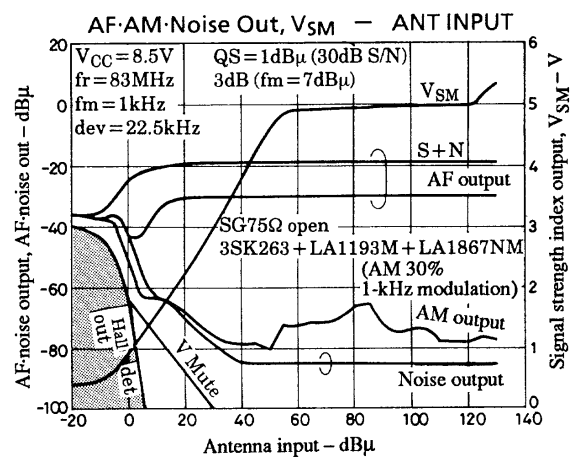
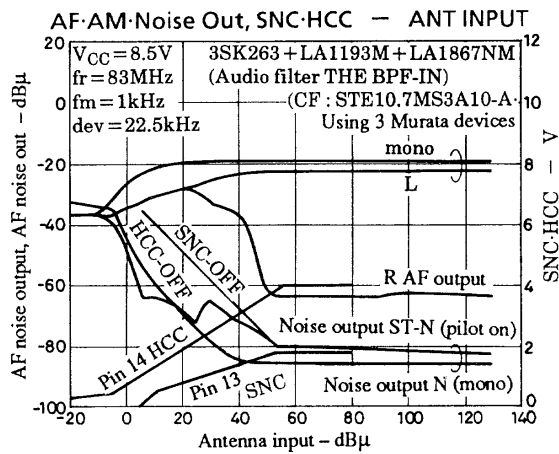
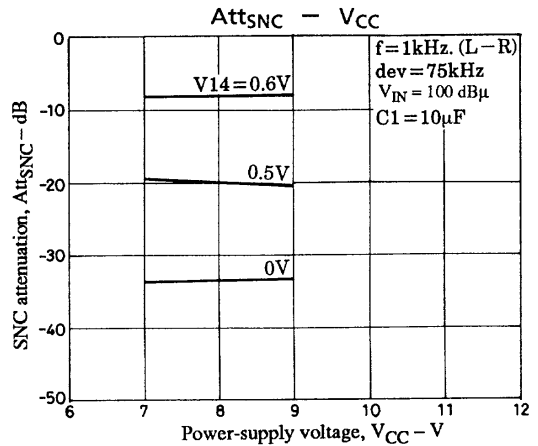
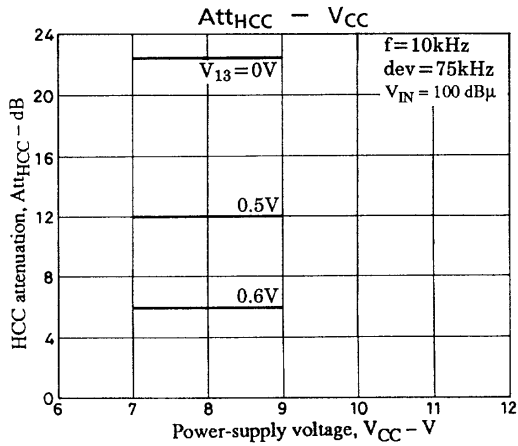

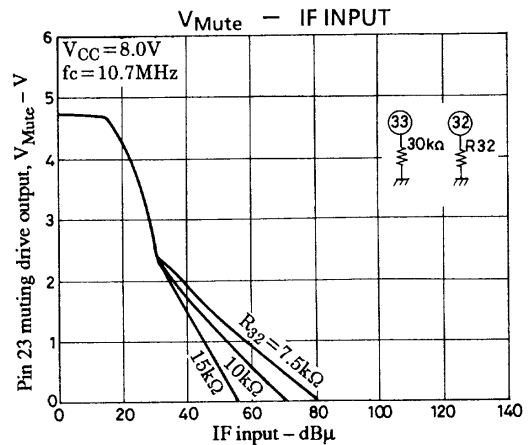
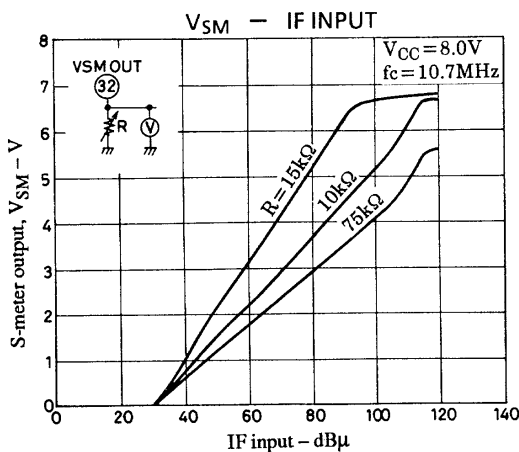
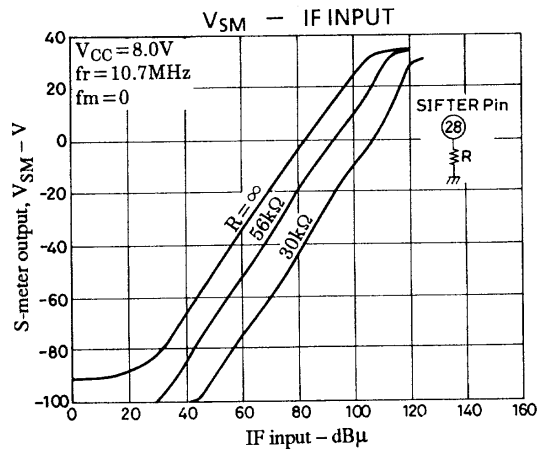
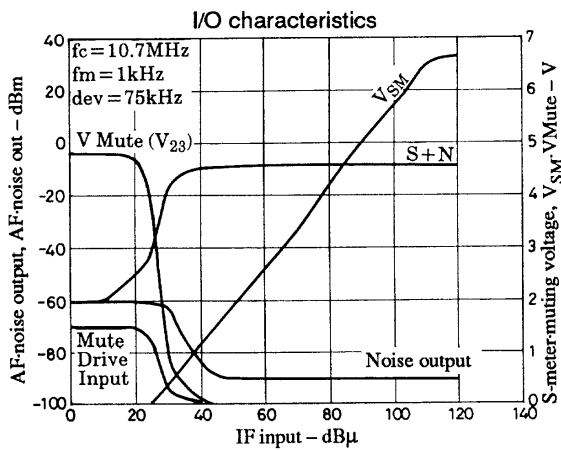
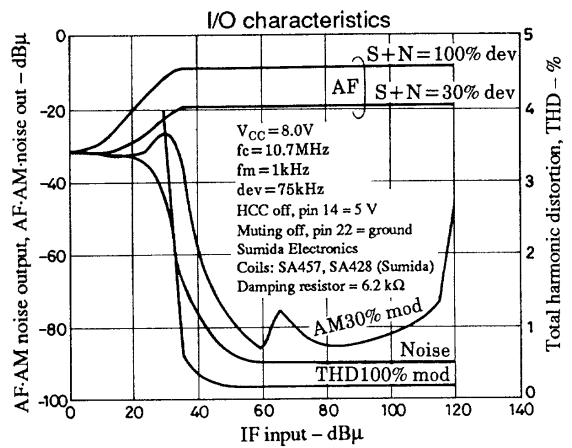
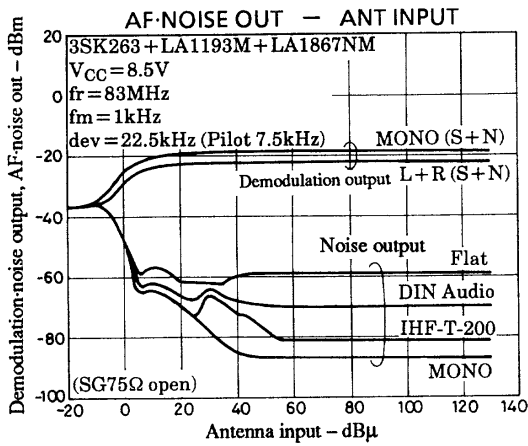
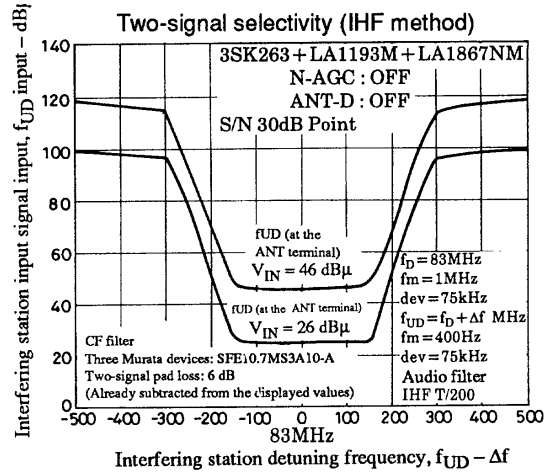
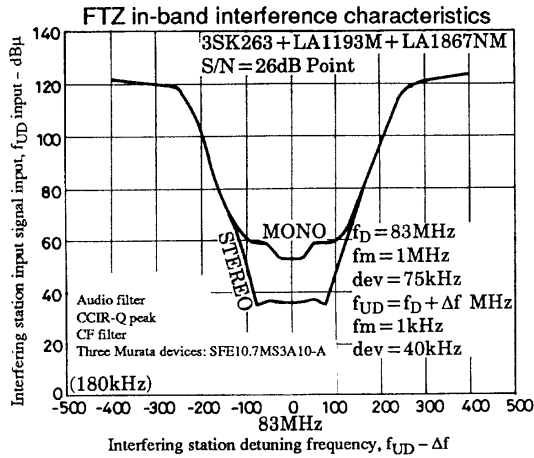

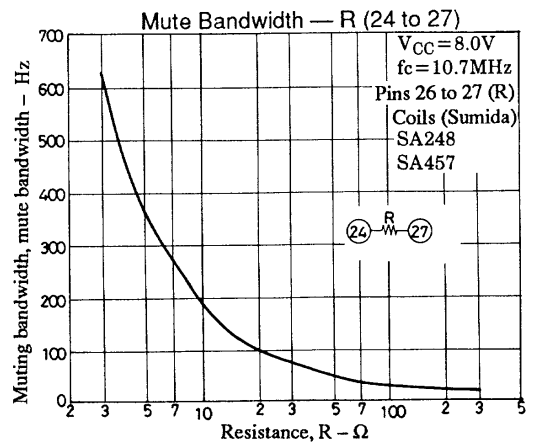
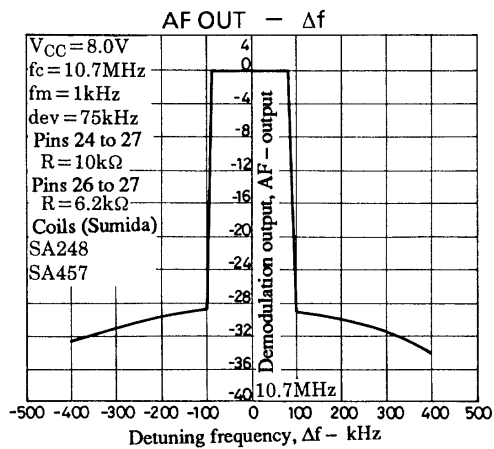
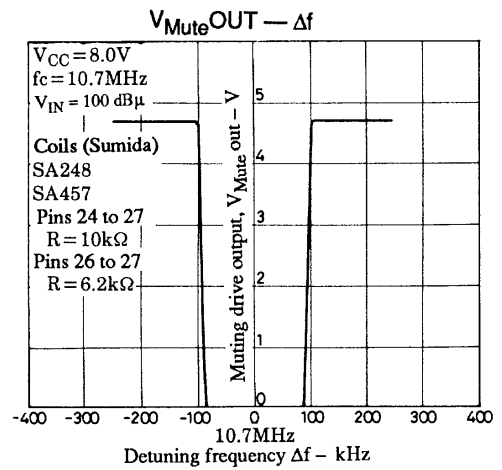
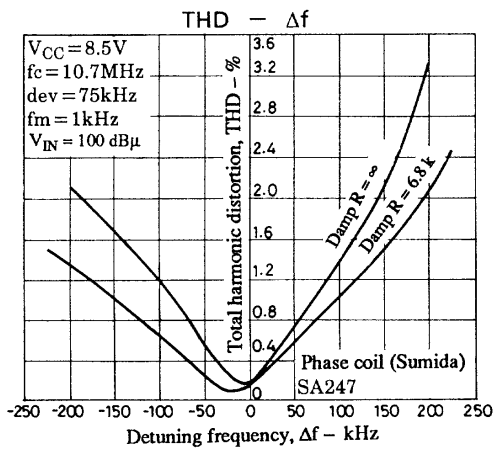
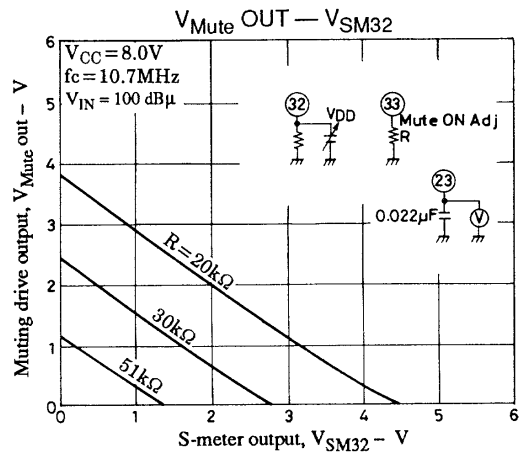
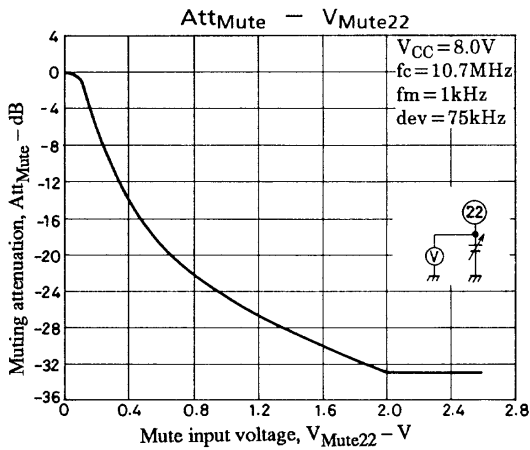
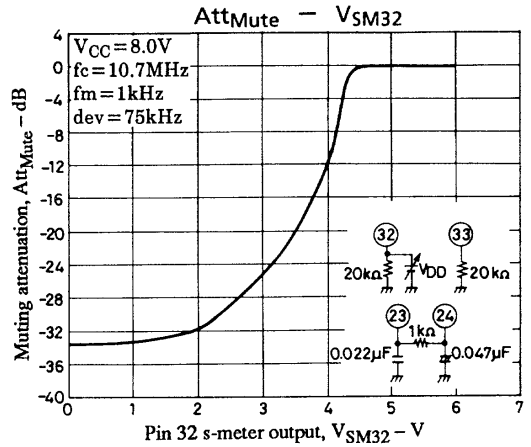
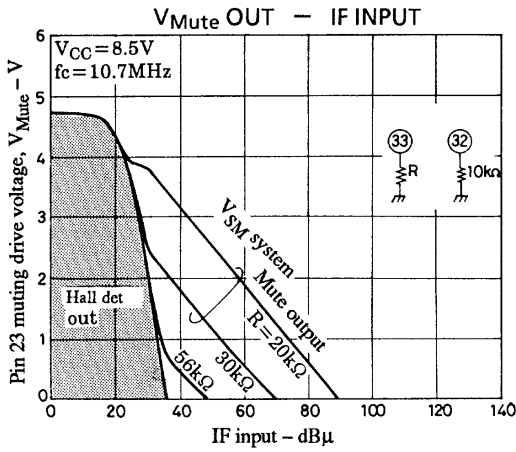

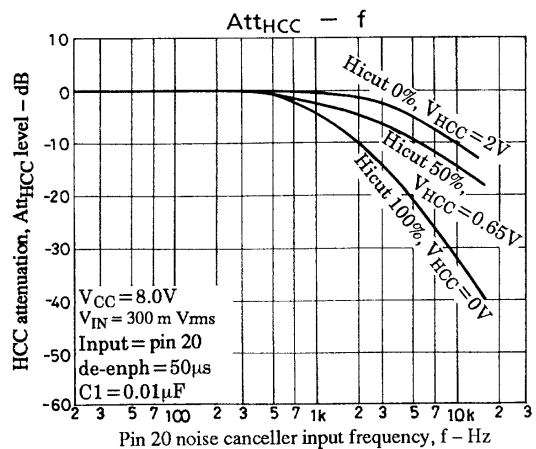
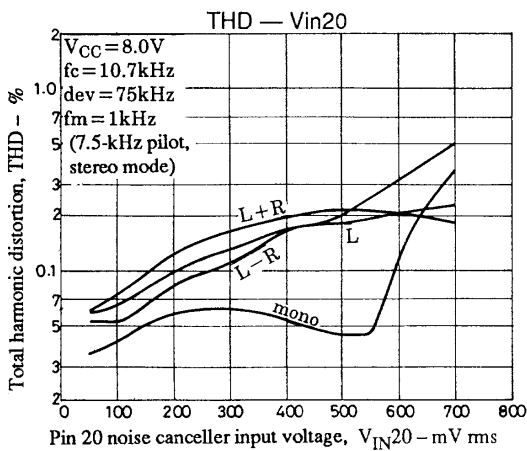
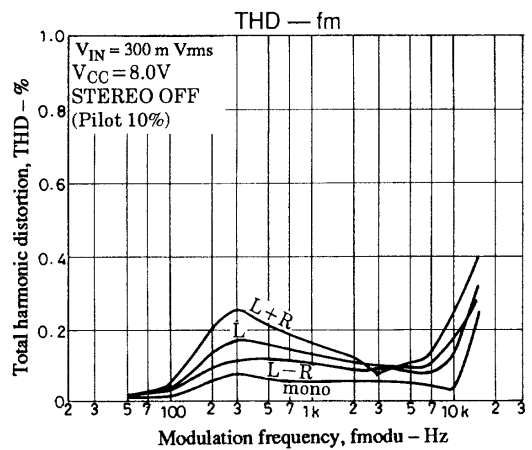
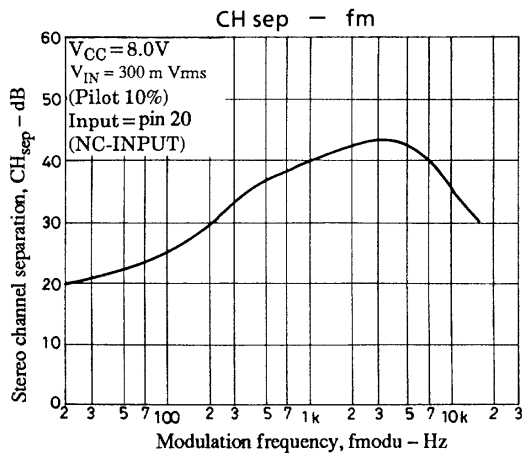
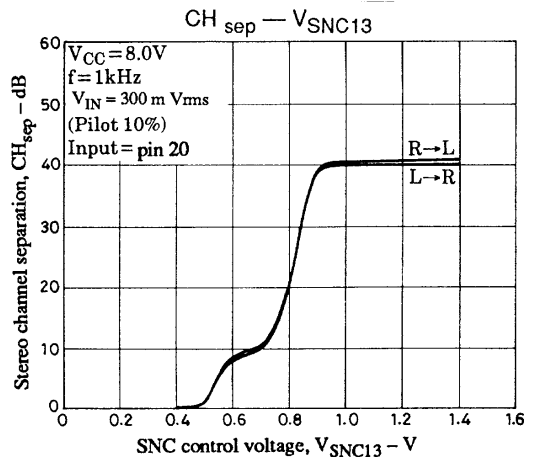
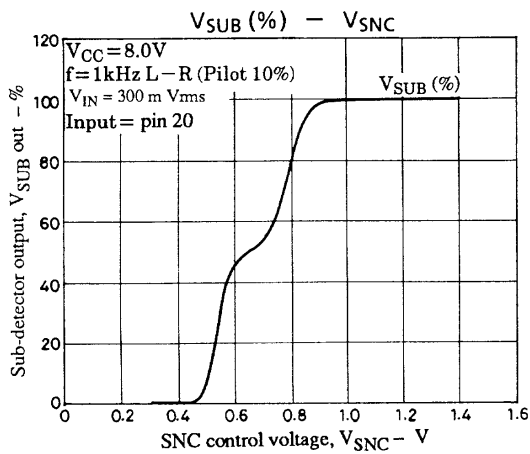
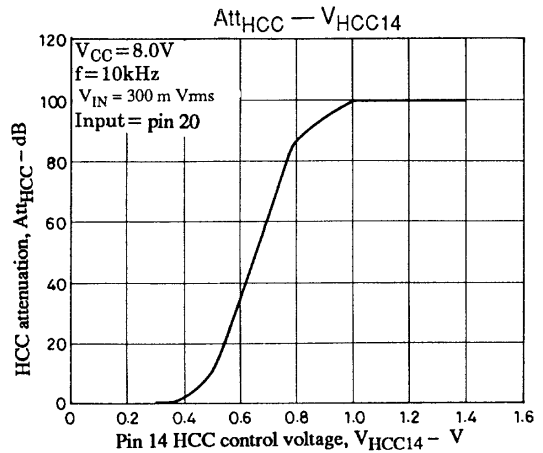
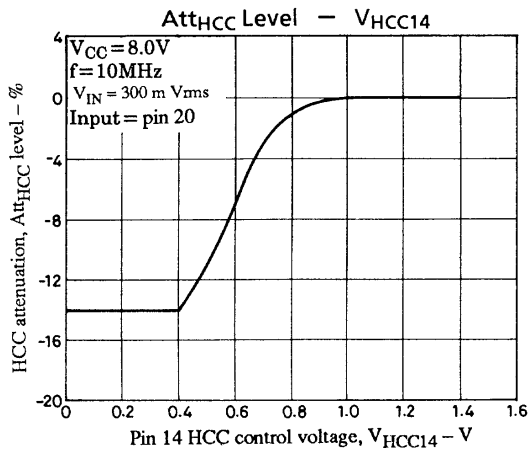

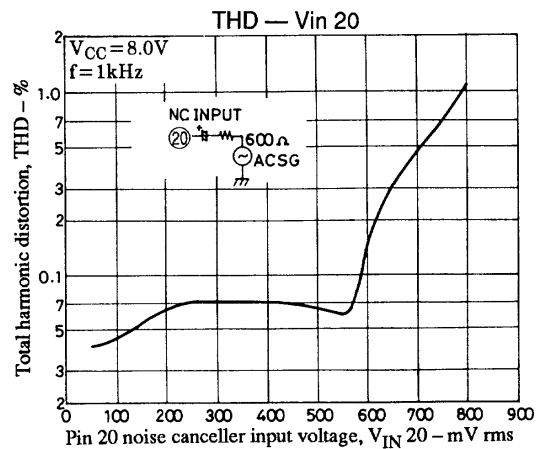
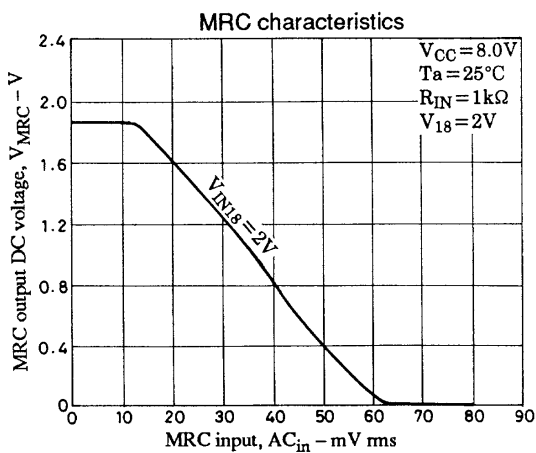
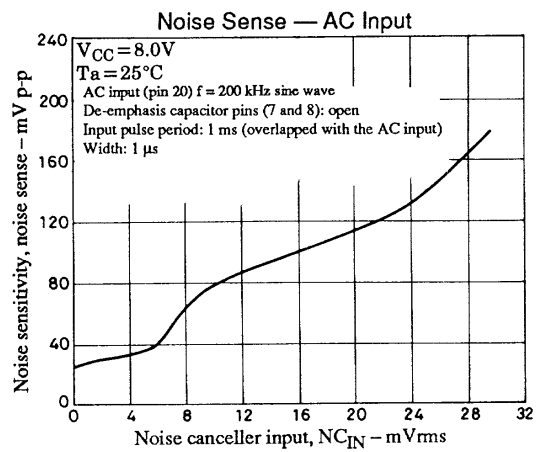
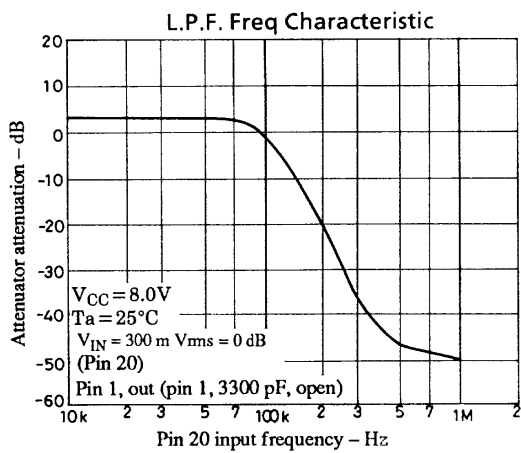
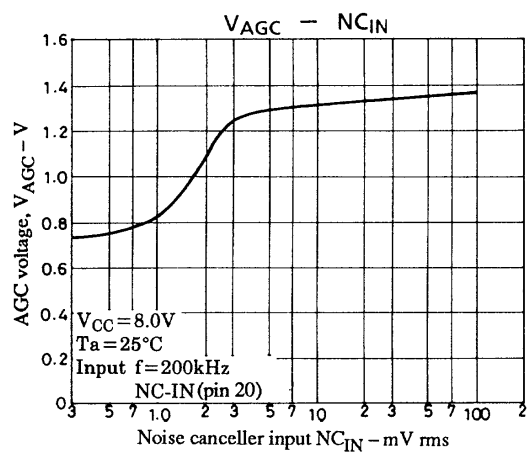
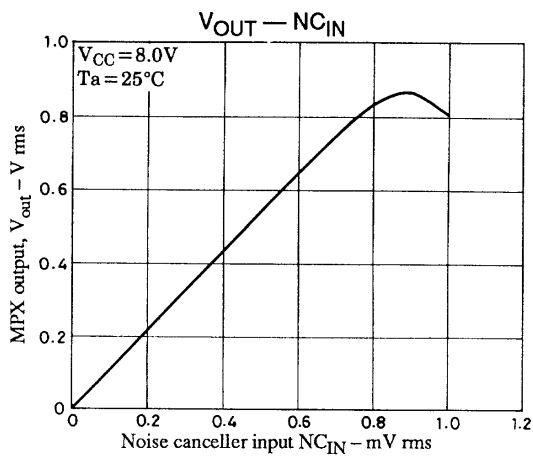
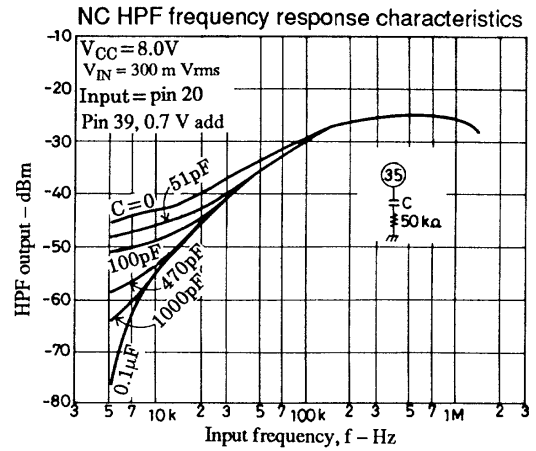
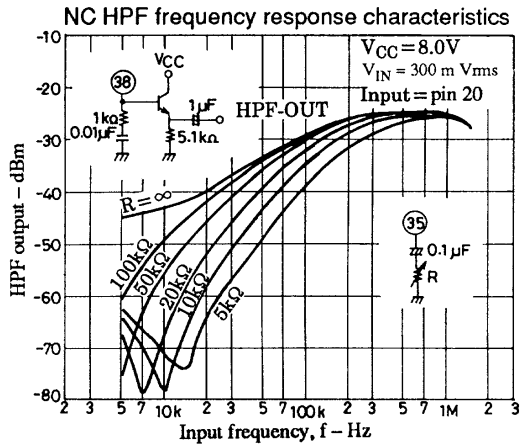

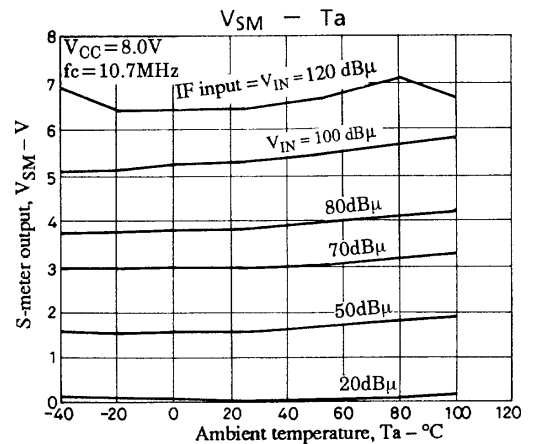
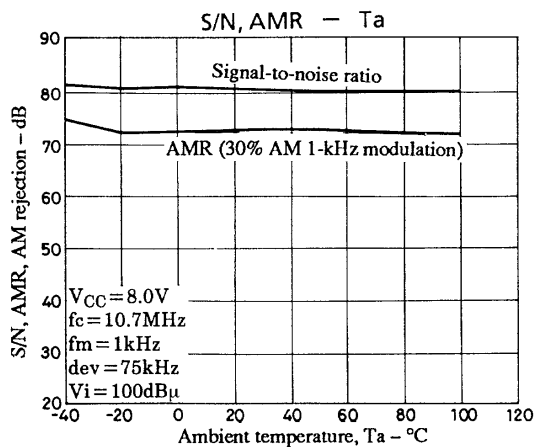
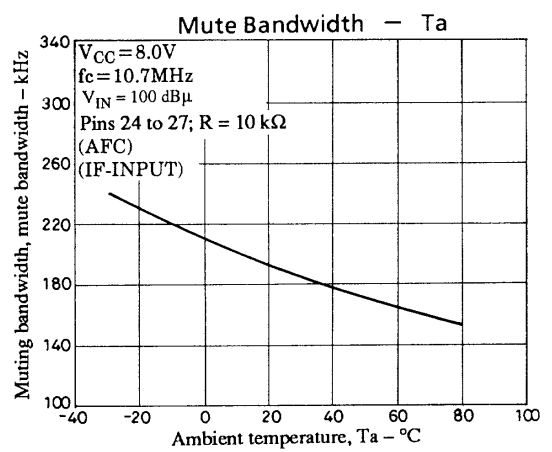
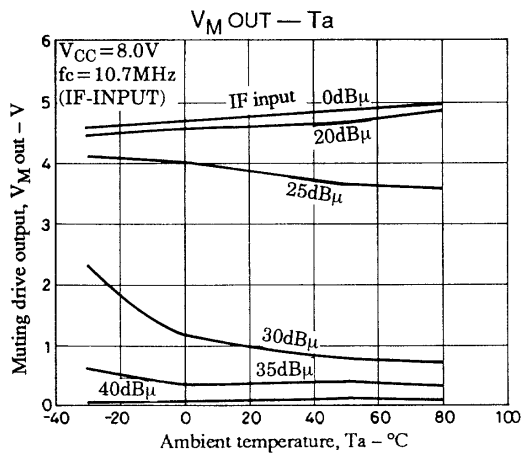
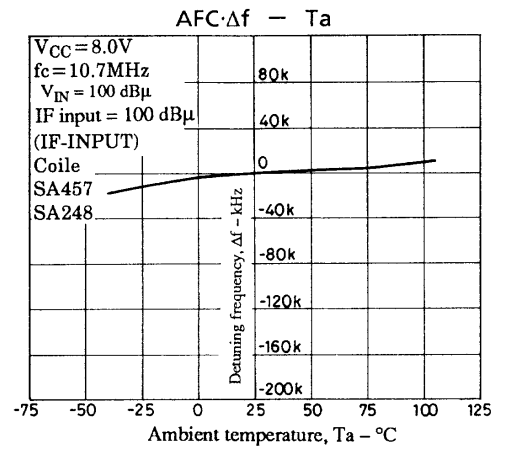
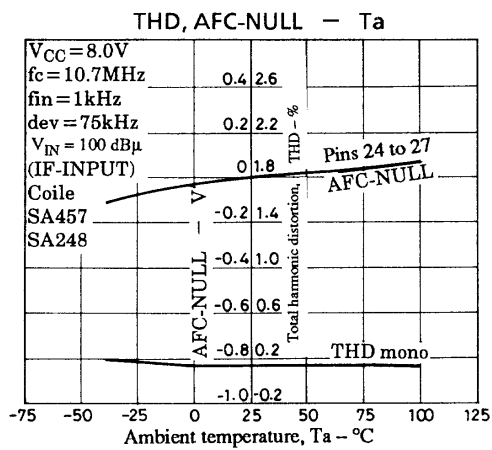
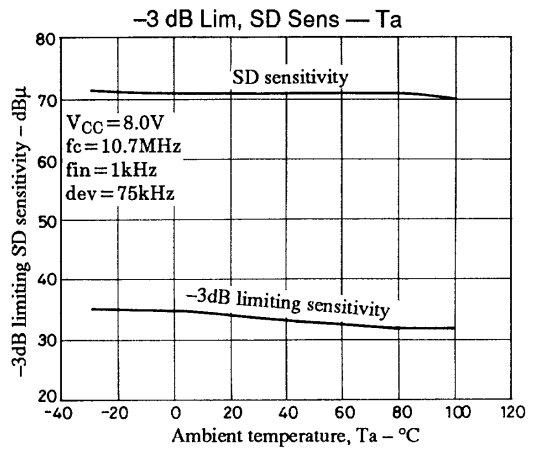
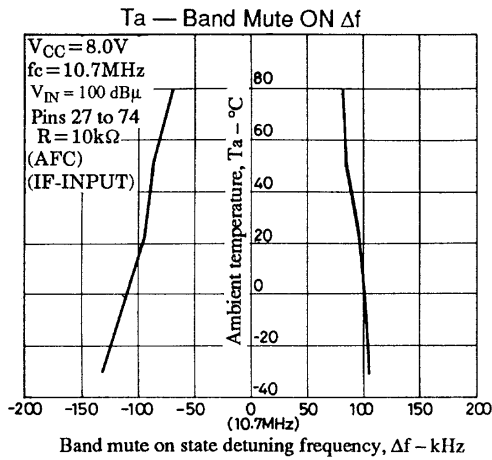

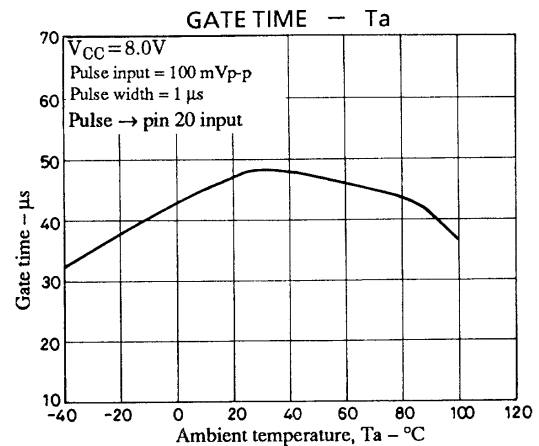
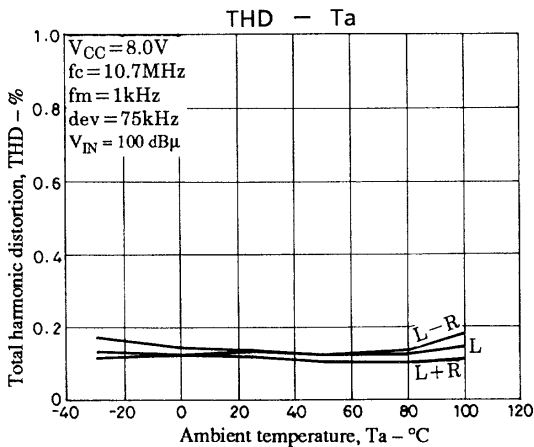
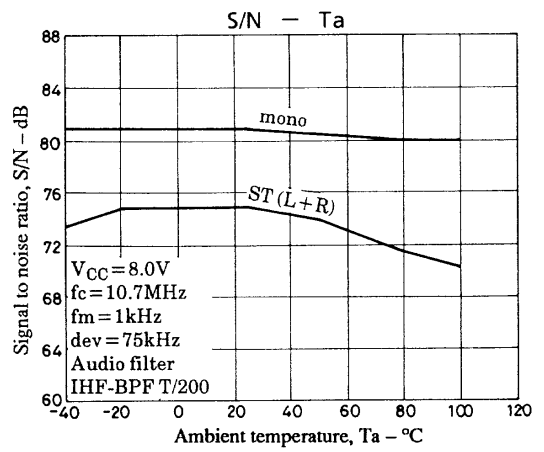
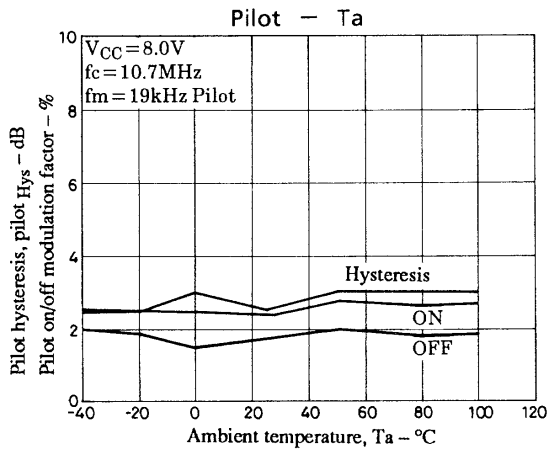
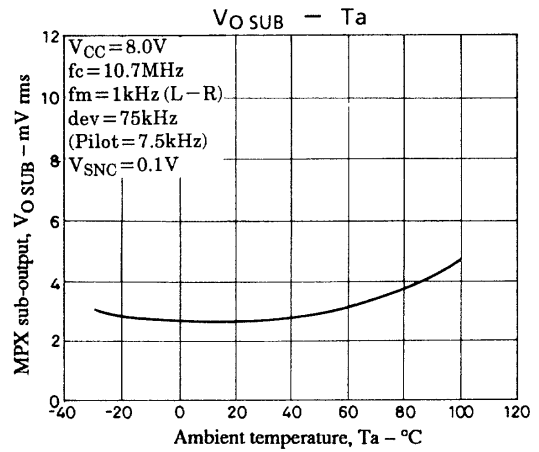
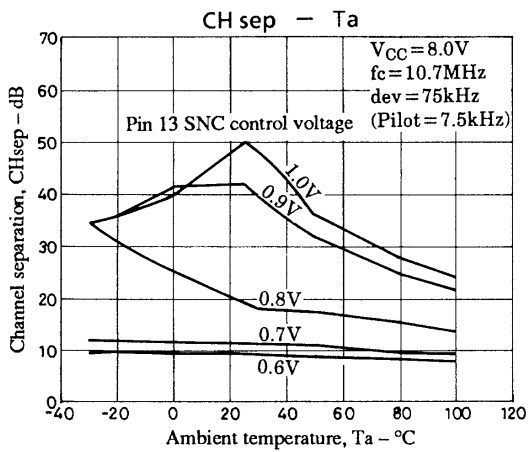
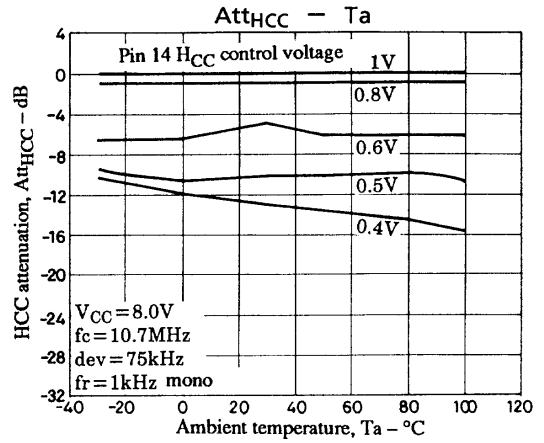
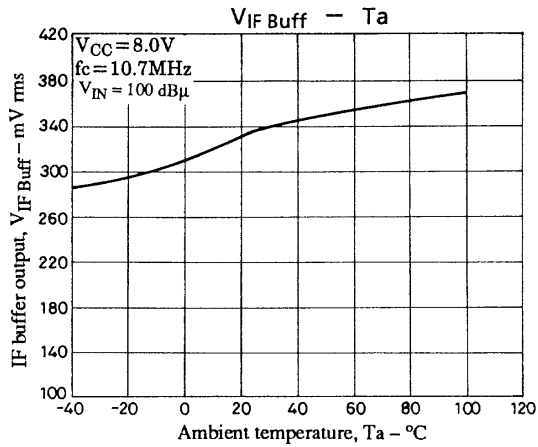

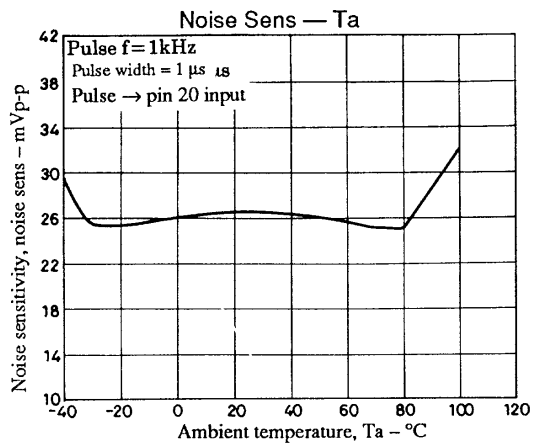

- No products described or contained herein are intended for use in surgical implants, life-support systems, aerospace equipment, nuclear power control systems, vehicles, disaster/crime-prevention equipment and the like, the failure of which may directly or indirectly cause injury, death or property loss.
- Anyone purchasing any products described or contained herein for an above-mentioned use shall:
 - ① Accept full responsibility and indemnify and defend SANYO ELECTRIC CO., LTD., its affiliates, subsidiaries and distributors and all their officers and employees, jointly and severally, against any and all claims and litigation and all damages, cost and expenses associated with such use:
 - ② Not impose any responsibility for any fault or negligence which may be cited in any such claim or litigation on SANYO ELECTRIC CO., LTD., its affiliates, subsidiaries and distributors or any of their officers and employees jointly or severally.
- Information (including circuit diagrams and circuit parameters) herein is for example only; it is not guaranteed for volume production. SANYO believes information herein is accurate and reliable, but no guarantees are made or implied regarding its use or any infringements of intellectual property rights or other rights of third parties.

This catalog provides information as of February, 1997. Specifications and information herein are subject to change without notice.