

# Hyper 3 mm (T1) LED, Diffused Hyper-Bright LED

LS 3366, LA 3366, LO 3366, LY 3366



## Besondere Merkmale

- **Gehäusotyp:** eingefärbtes, diffuses 3 mm (T1) Gehäuse
- **Besonderheit des Bauteils:** Lötspieße mit Aufsetzebene
- **Wellenlänge:** 633 nm (super-rot), 615 nm (amber), 606 nm (orange), 587 nm (gelb)
- **Abstrahlwinkel:** 70°
- **Technologie:** InGaAlP
- **optischer Wirkungsgrad:** 11 lm/W (gelb, orange, amber), 7 lm/W (super-rot)
- **Gruppierungsparameter:** Lichtstärke
- **Lötmethode:** Wellenlöten (TTW)
- **Verpackung:** Schüttgut, gegurtet lieferbar
- **ESD-Festigkeit:** ESD-sicher bis 2 kV nach EOS/ESD-5.1-1993

## Anwendungen

- optischer Indikator
- Hinterleuchtung (LCD, Schalter, Tasten, Displays, Werbebeleuchtung, Allgemeinbeleuchtung)
- Innenbeleuchtung im Automobilbereich (z.B. Instrumentenbeleuchtung, u.ä.)
- Markierungsbeleuchtung (z.B. Stufen, Fluchtwege, u.ä.)
- Signal- und Symbolleuchten

## Features

- **package:** colored, diffused 3 mm (T1) package
- **feature of the device:** solder leads with stand-off
- **wavelength:** 633 nm (super-red), 615 nm (amber), 606 nm (orange), 587 nm (yellow)
- **viewing angle:** 70°
- **technology:** InGaAlP
- **optical efficiency:** 11 lm/W (yellow, orange, amber), 7 lm/W (super-red)
- **grouping parameter:** luminous intensity
- **soldering methods:** TTW soldering
- **packing:** bulk, available taped on reel
- **ESD-withstand voltage:** up to 2 kV acc. to EOS/ESD-5.1-1993

## Applications

- coupling into light guides
- backlighting (LCD, switches, keys, displays, illuminated advertising, general lighting)
- interior automotive lighting. (e.g. dashboard backlighting, etc.)
- marker lights (e.g. steps, exit ways, etc.)
- signal and symbol luminaire

Typ Type	Emissions- farbe Color of Emission	Gehäuse- farbe Color of Package	Lichtstärke Luminous Intensity $I_F = 20 \text{ mA}$ $I_V \text{ (mcd)}$	Lichtstrom Luminous Flux $I_F = 20 \text{ mA}$ $\Phi_V \text{ (mlm)}$	Bestellnummer Ordering Code
LS 3366-NR LS 3366-Q LS 3366-R LS 3366-PS LS 3366-R1S2	super-red	red diffused	28 ... 180 71 ... 112 112 ... 180 45 ... 280 112 ... 280	360 (typ.) 300 (typ.) 480 (typ.) 580 (typ.) 650 (typ.)	Q62703Q3457 Q62703Q3459 Q62703Q3460 Q62703Q3461 Q65110A0560
LA 3366-PS LA 3366-Q LA 3366-R LA 3366-S LA 3366-QT	amber	orange diffused	45 ... 280 71 ... 112 112 ... 180 180 ... 280 71 ... 450	540 (typ.) 280 (typ.) 450 (typ.) 720 (typ.) 840 (typ.)	Q62703Q3881 Q62703Q3882 Q62703Q3883 Q62703Q3884 Q62703Q3885
LO 3366-PS LO 3366-Q LO 3366-R LO 3366-S LO 3366-QT	orange	orange diffused	45 ... 280 71 ... 112 112 ... 180 180 ... 280 71 ... 450	540 (typ.) 280 (typ.) 450 (typ.) 720 (typ.) 840 (typ.)	Q62703Q3127 Q62703Q3172 Q62703Q3173 Q62703Q3174 Q62703Q3175
LY 3366-PS LY 3366-Q LY 3366-R LY 3366-S LY 3366-QT	yellow	yellow diffused	45 ... 280 71 ... 112 112 ... 180 180 ... 280 71 ... 450	540 (typ.) 280 (typ.) 450 (typ.) 720 (typ.) 840 (typ.)	Q62703Q3462 Q62703Q3464 Q62703Q3465 Q62703Q3463 Q62703Q3466

Anm.: Die Standardlieferform von Serientypen beinhaltet eine untere bzw. eine obere Familiengruppe oder mindestens zwei Einzelgruppen.

In einer Verpackungseinheit / Gurt ist immer nur eine Helligkeitsgruppe enthalten.

Die technologiebedingte Helligkeits-Streuung der heutigen LED-Herstellprozesse über einen längeren Fertigungszeitraum (Halbleitermaterial - Chipherstellung - Montageprozess) erlaubt keine Zusage einer einzelnen Helligkeitsgruppe. Daher müssen mindestens zwei Helligkeitsgruppen vorgesehen werden!

Note: The standard shipping format for serial types includes a lower or upper family group or at least two individual groups.

No packing unit / tape ever contains more than one luminous intensity group.

Luminosity variations caused by the technology used in current LED manufacturing processes over a protracted manufacturing period (semiconductor material - chip fabrication - assembly process) mean that it is not possible to assign LEDs to a single luminous intensity group. For this reason at least two luminous intensity groups must be provided!

**Grenzwerte**  
**Maximum Ratings**

Bezeichnung Parameter	Symbol Symbol	Werte Values		Einheit Unit
		LS, LO, LA	LY	
Betriebstemperatur Operating temperature range	$T_{op}$	- 55 ... + 100		°C
Lagertemperatur Storage temperature range	$T_{stg}$	- 55 ... + 100		°C
Sperrschichttemperatur Junction temperature	$T_j$	+ 100		°C
Durchlassstrom Forward current	$I_F$	30		mA
Stoßstrom Surge current $t \leq 10 \mu s, D = 0.005$	$I_{FM}$	1	0.2	A
Sperrspannung <sup>1)</sup> Reverse voltage	$V_R$	12		V
Leistungsaufnahme Power consumption $T_A \leq 25 \text{ °C}$	$P_{tot}$	80		mW
Wärmewiderstand <sup>2)</sup> Thermal resistance Sperrschicht/Umgebung Junction/ambient	$R_{th JA}$	500		K/W
Sperrschicht/Löt看 Junction/solder point Montage auf PC-Board FR 4 (Padgröße $\geq 16 \text{ mm}^2$ ) mounted on PC board FR 4 (pad size $\geq 16 \text{ mm}^2$ ) Minimale Beinchenlänge Minimum lead length	$R_{th JS}$	280		K/W

1) für kurzzeitigen Betrieb geeignet / suitable for short term application

2)  $R_{th}$  erhöht sich um 13 K/W pro mm Beinchenlänge.  
Each additional 1 mm of lead length increases  $R_{th}$  by 13 K/W.

**Kennwerte** ( $T_A = 25\text{ °C}$ )

**Characteristics**

Bezeichnung Parameter	Symbol Symbol	Werte Values				Einheit Unit
		LS	LA	LO	LY	
Wellenlänge des emittierten Lichtes Wavelength at peak emission $I_F = 20\text{ mA}$	(typ.) $\lambda_{\text{peak}}$	645	622	610	591	nm
Dominantwellenlänge Dominant wavelength $I_F = 20\text{ mA}$	(typ.) $\lambda_{\text{dom}}$	633	615	606	587	nm
Spektrale Bandbreite bei 50 % $I_{\text{rel max}}$ Spectral bandwidth at 50 % $I_{\text{rel max}}$ $I_F = 20\text{ mA}$	(typ.) $\Delta\lambda$	16	16	16	15	nm
Abstrahlwinkel bei 50 % $I_V$ (Vollwinkel) Viewing angle at 50 % $I_V$	(typ.) $2\phi$	70	70	70	70	Grad deg.
Durchlassspannung <sup>1)</sup> Forward voltage <sup>1)</sup> $I_F = 20\text{ mA}$	(typ.) $V_F$ (max.) $V_F$	2.0 2.4	2.0 2.4	2.0 2.4	2.0 2.4	V V
Sperrstrom Reverse current $V_R = 12\text{ V}$	(typ.) $I_R$ (max.) $I_R$	0.01 10	0.01 10	0.01 10	0.01 10	$\mu\text{A}$ $\mu\text{A}$
Temperaturkoeffizient von $\lambda_{\text{peak}}$ Temperature coefficient of $\lambda_{\text{peak}}$ $I_F = 20\text{ mA}; -10\text{ °C} \leq T \leq 100\text{ °C}$	(typ.) $TC_{\lambda_{\text{peak}}}$	0.14	0.13	0.13	0.13	nm/K
Temperaturkoeffizient von $\lambda_{\text{dom}}$ Temperature coefficient of $\lambda_{\text{dom}}$ $I_F = 20\text{ mA}; -10\text{ °C} \leq T \leq 100\text{ °C}$	(typ.) $TC_{\lambda_{\text{dom}}}$	0.05	0.06	0.07	0.10	nm/K
Temperaturkoeffizient von $V_F$ Temperature coefficient of $V_F$ $I_F = 20\text{ mA}; -10\text{ °C} \leq T \leq 100\text{ °C}$	(typ.) $TC_V$	-2.0	-1.8	-1.7	-2.5	mV/K
Optischer Wirkungsgrad Optical efficiency $I_F = 20\text{ mA}$	(typ.) $\eta_{\text{opt}}$	7	11	11	11	lm/W

<sup>1)</sup> Spannungswerte werden mit einer Stromeinprägedauer von 1 ms und einer Genauigkeit von  $\pm 0,1\text{ V}$  ermittelt.  
Voltages are tested at a current pulse duration of 1 ms and a tolerance of  $\pm 0.1\text{ V}$ .

**Helligkeits-Gruppierungsschema**  
**Luminous Intensity Groups**

<b>Lichtgruppe</b> <b>Luminous Intensity Group</b>	<b>Lichtstärke</b> <b>Luminous Intensity</b> <b><math>I_v</math> (mcd)</b>	<b>Lichtstrom</b> <b>Luminous Flux</b> <b><math>\Phi_v</math> (mlm)</b>
N	28 ... 45	115 (typ.)
P	45 ... 71	190 (typ.)
Q	71 ... 112	300 (typ.)
R	112 ... 180	480 (typ.)
S	180 ... 280	720 (typ.)
T	280 ... 450	1150 (typ.)

Helligkeitswerte werden mit einer Stromeinprägedauer von 25 ms und einer Genauigkeit von  $\pm 11\%$  ermittelt.  
 Luminous intensity is tested at a current pulse duration of 25 ms and a tolerance of  $\pm 11\%$ .

Relative spektrale Emission  $I_{rel} = f(\lambda)$ ,  $T_A = 25\text{ °C}$ ,  $I_F = 20\text{ mA}$

**Relative Spectral Emission**

$V(\lambda)$  = spektrale Augenempfindlichkeit

Standard eye response curve

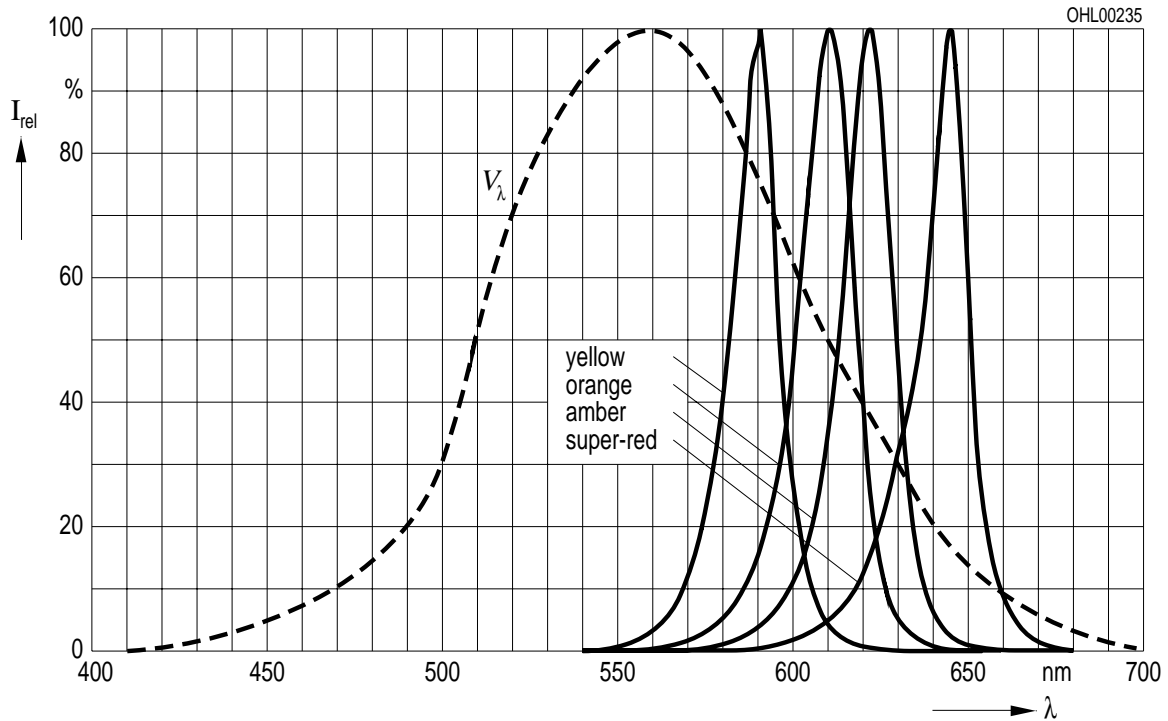

Abstrahlcharakteristik  $I_{rel} = f(\varphi)$

**Radiation Characteristic**

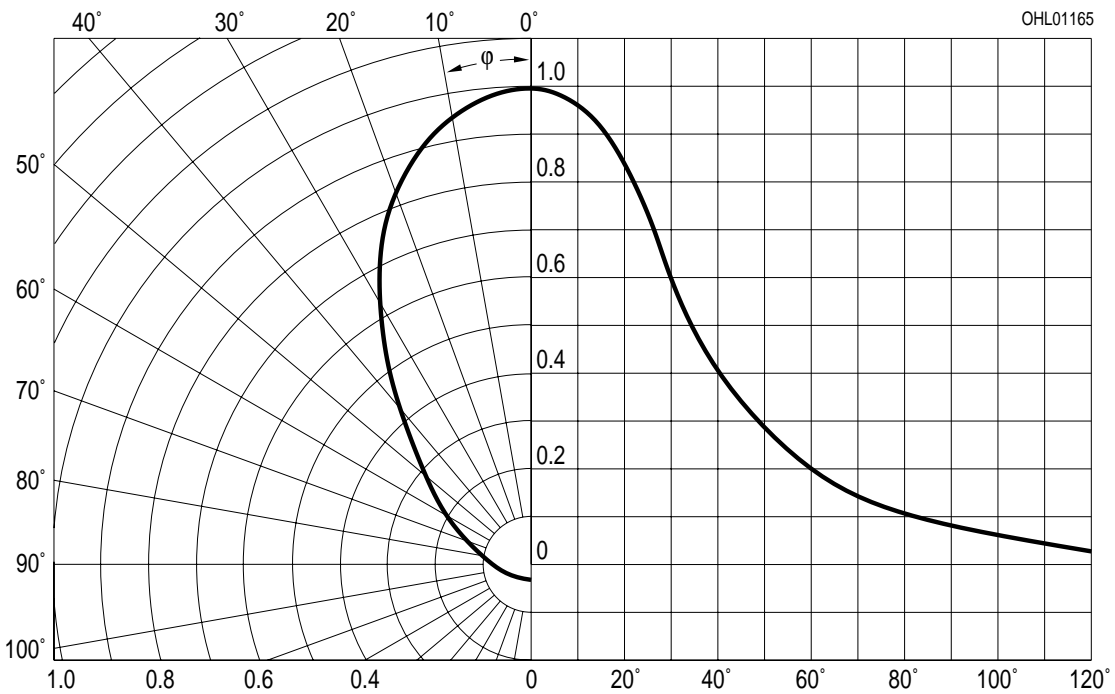

**Durchlassstrom  $I_F = f(V_F)$**   
**Forward Current**

$T_A = 25\text{ °C}$

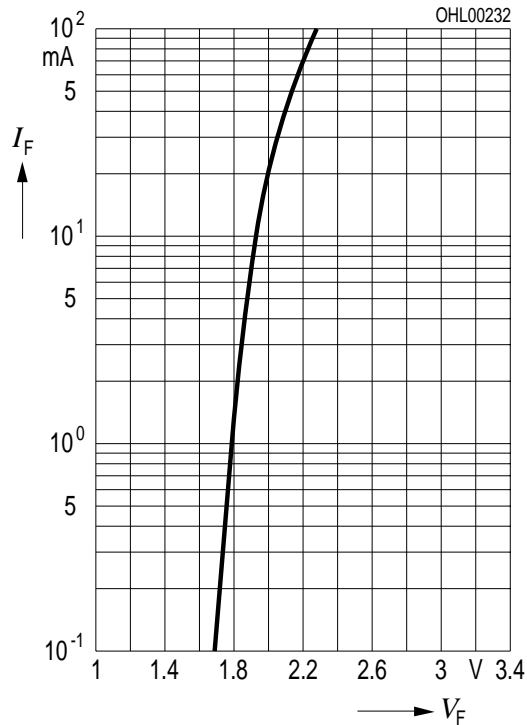

**Relative Lichtstärke  $I_V/I_{V(20\text{ mA})} = f(I_F)$**   
**Relative Luminous Intensity**

$T_A = 25\text{ °C}$

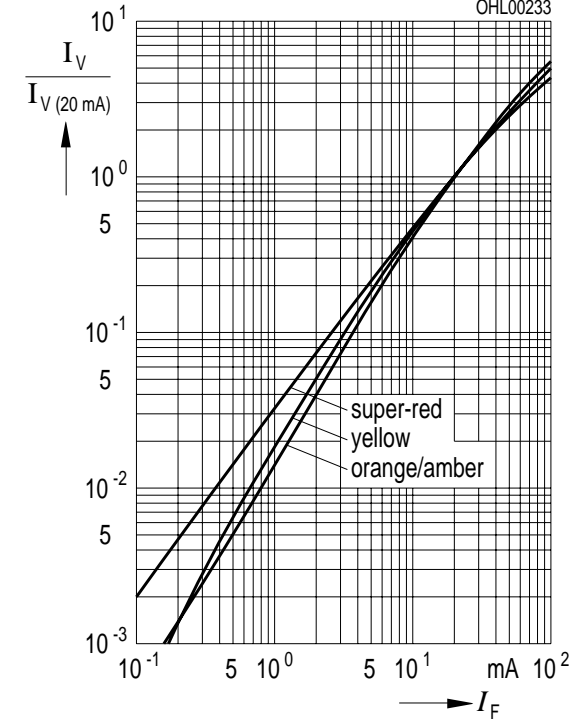

**Maximal zulässiger Durchlassstrom  $I_F = f(T)$**   
**Max. Permissible Forward Current**

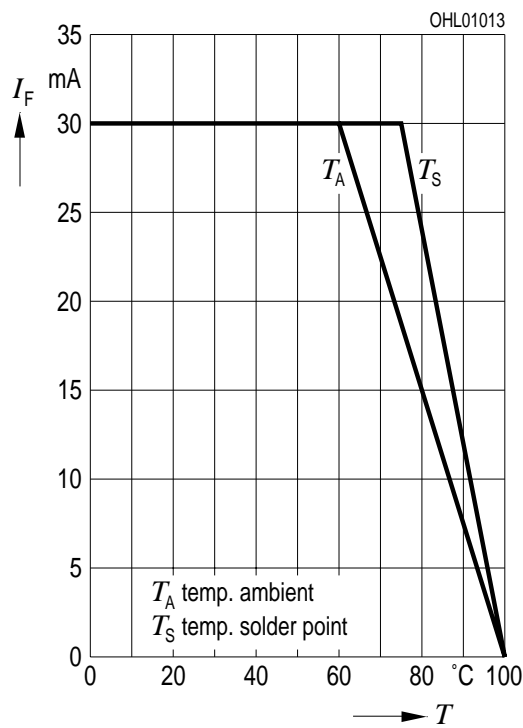

**Relative Lichtstärke  $I_V/I_{V(25\text{ °C})} = f(T_A)$**   
**Relative Luminous Intensity**

$I_F = 20\text{ mA}$

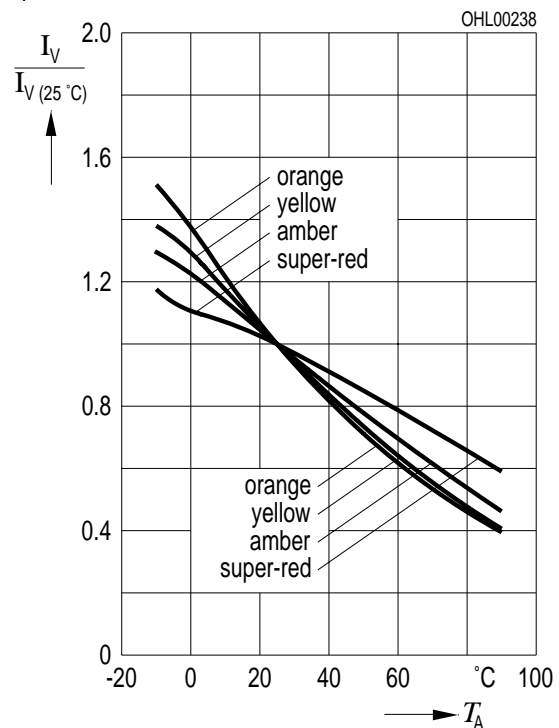

**Zulässige Impulsbelastbarkeit  $I_F = f(t_p)$**   
**Permissible Pulse Handling Capability**  
 Duty cycle  $D =$  parameter,  $T_A = 25\text{ °C}$   
**LS, LA, LO**

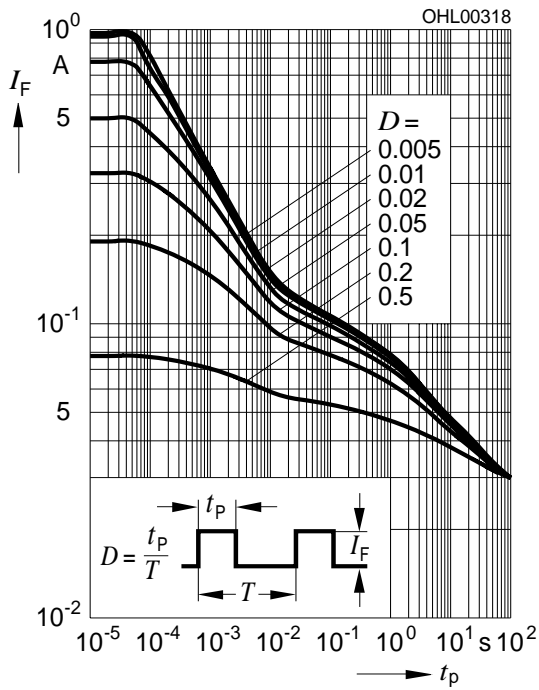

**Zulässige Impulsbelastbarkeit  $I_F = f(t_p)$**   
**Permissible Pulse Handling Capability**  
 Duty cycle  $D =$  parameter,  $T_A = 25\text{ °C}$   
**LY**

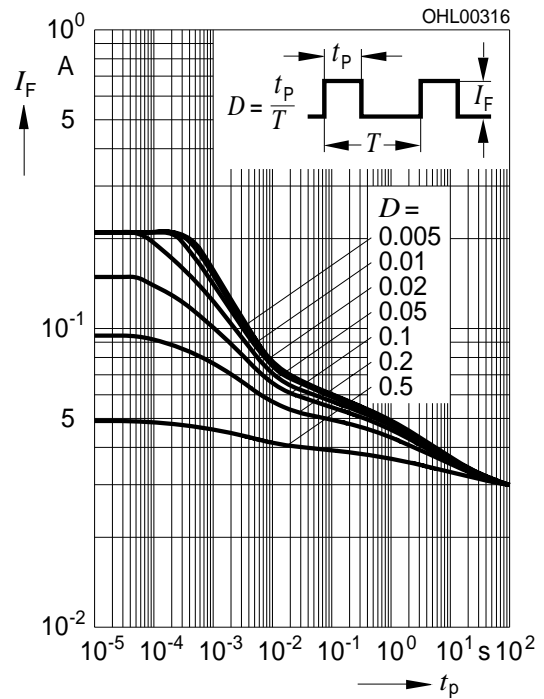

**Zulässige Impulsbelastbarkeit  $I_F = f(t_p)$**   
**Permissible Pulse Handling Capability**  
 Duty cycle  $D =$  parameter,  $T_A = 85\text{ °C}$   
**LS, LA, LO**

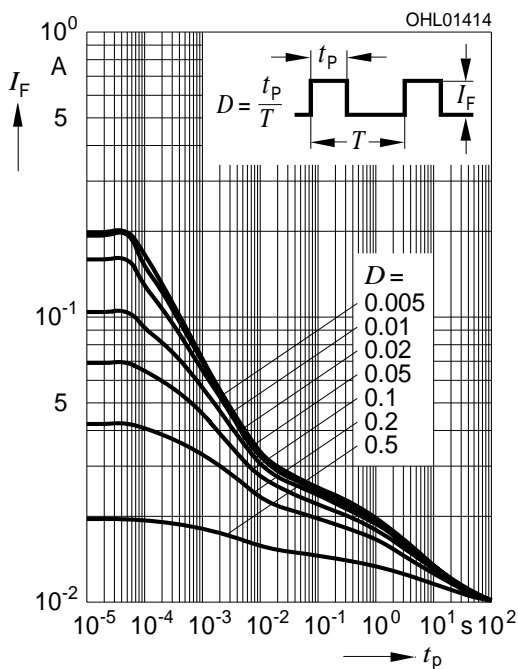

**Zulässige Impulsbelastbarkeit  $I_F = f(t_p)$**   
**Permissible Pulse Handling Capability**  
 Duty cycle  $D =$  parameter,  $T_A = 85\text{ °C}$   
**LY**

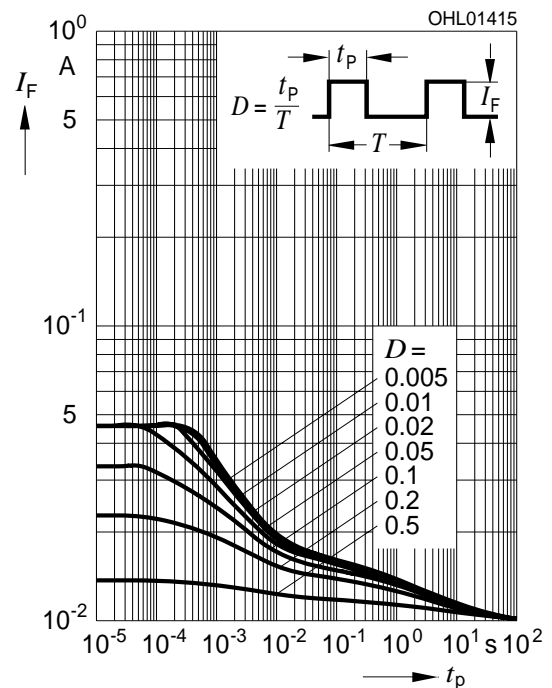





**Lötbedingungen**  
**Soldering Conditions**

**Wellenlöten (TTW)** (nach CECC 00802)  
**TTW Soldering** (acc. to CECC 00802)

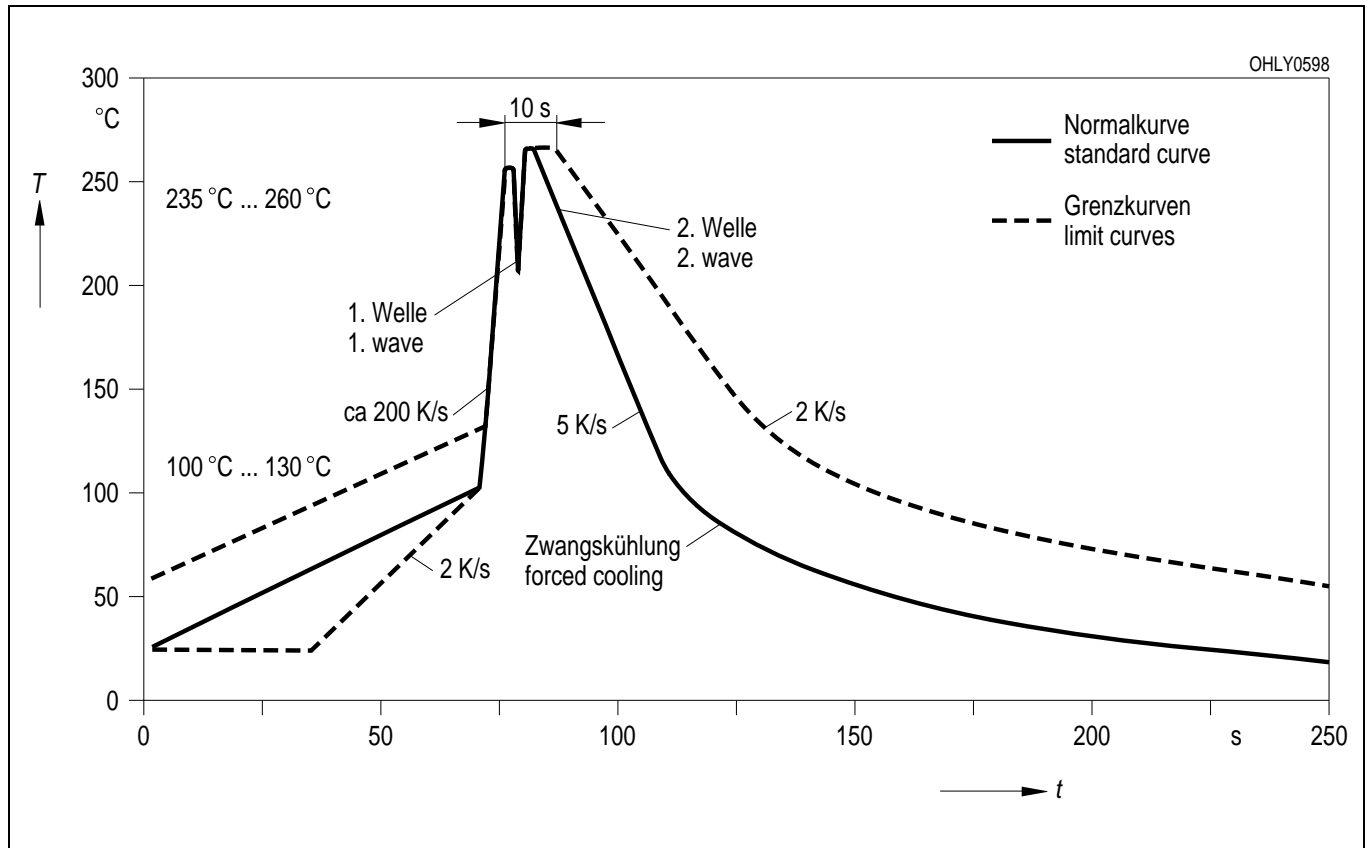

**Empfohlenes Lötpaddesign** Wellenlöten (TTW)  
**Recommended Solder Pad** TTW Soldering

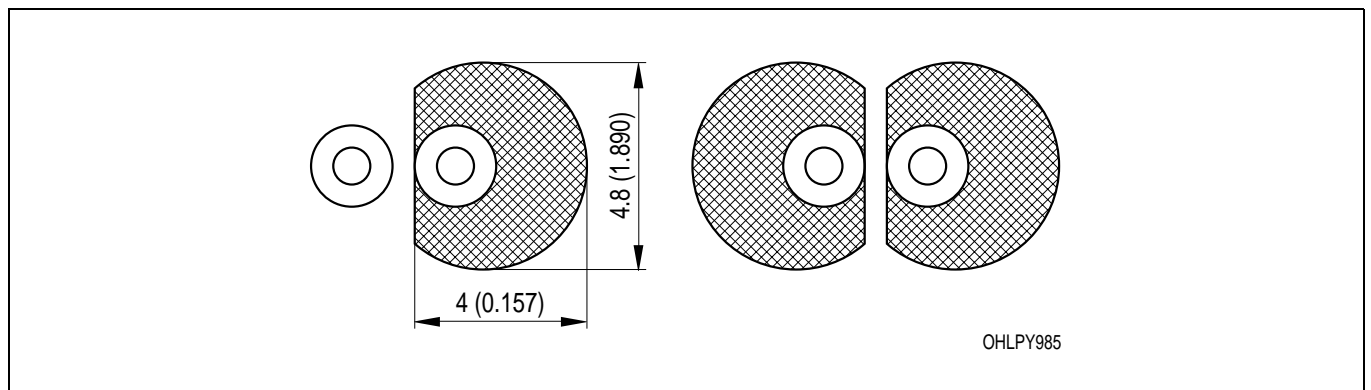

Maße werden wie folgt angegeben: mm (inch) / Dimensions are specified as follows: mm (inch)

Revision History: 2003-03-10		Date of change
Previous Version: 2002-12-06		
Page	Subjects (major changes since last revision)	
3	thermal resistance (footnote)	
4	value (wavelength super-red/amber/orange)	
10	annotations	2002-07-25
4	value ( $TC_{\lambda_{dom}}$ from 0.01 to 0.05 nm/K)	2002-07-25
5	luminous intensity groups	2002-07-30
3, 4	value (reverse voltage from 3 V to 12 V)	2002-09-18
2	LS 3366-P is "Not for new designs"	2002-10-18
2	new type LS 3366-R1S2	2002-11-04
1	ESD-withstand voltage	2002-12-06
2	LS 3366-P deleted	2003-03-10

**Published by OSRAM Opto Semiconductors GmbH**  
**Wernerwerkstrasse 2, D-93049 Regensburg**  
**© All Rights Reserved.**

**Attention please!**

The information describes the type of component and shall not be considered as assured characteristics. All typical data and graphs are basing on representative samples, but don't represent the production range. If requested, e.g. because of technical improvements, these typ. data will be changed without any further notice. Terms of delivery and rights to change design reserved. Due to technical requirements components may contain dangerous substances. For information on the types in question please contact our Sales Organization. If printed or downloaded, please find the latest version in the Internet.

**Packing**

Please use the recycling operators known to you. We can also help you – get in touch with your nearest sales office. By agreement we will take packing material back, if it is sorted. You must bear the costs of transport. For packing material that is returned to us unsorted or which we are not obliged to accept, we shall have to invoice you for any costs incurred.

**Components used in life-support devices or systems must be expressly authorized for such purpose!** Critical components <sup>1</sup> may only be used in life-support devices or systems <sup>2</sup> with the express written approval of OSRAM OS.

<sup>1</sup> A critical component is a component used in a life-support device or system whose failure can reasonably be expected to cause the failure of that life-support device or system, or to affect its safety or the effectiveness of that device or system.

<sup>2</sup> Life support devices or systems are intended (a) to be implanted in the human body, or (b) to support and/or maintain and sustain human life. If they fail, it is reasonable to assume that the health of the user may be endangered.