



LA3401

VCO Non-Adjusting PLL FM MPX Stereo Demodulator with FM Accessories

Overview

The LA3401 is a multifunctional MPX demodulator IC designed for FM stereo electronic tuning. It features the VCO non-adjusting function that eliminates the need to adjust free-running frequency of VCO and the accessory functions such as FM/AM input, FM/AM input changeover, muting.

Applications

- Home stereos, portable hi-fi sets.

Functions

- VCO non-adjusting function.
- PLL MPX stereo demodulator.
- Gain variable type post amplifier.
- FM-AM changeover.
- Muting at the FM-AM changeover mode (changeover mute)
- Muting function.
- Drive pin for external muting.
- VCO stop function.
- Separation adjust function.
- Muting at the V_{CC}-ON mode.

Features

- Non-adjusting VCO : Eliminates the need to adjust free-running frequency.
- Good temperature characteristic of VCO : $\pm 0.1\%$ typ. for $\pm 50^\circ\text{C}$ change.
- Less high frequency distortion of stereo main signal (0.07% typ. at $f=10\text{kHz}$) (Non-adjusting PLL makes it possible to make the capture range narrower, providing less high frequency beat distortion of stereo main signal.)
- Low distortion : Mono 0.01% typ.
Main 0.025% typ.
- High S/N : 91dB typ./mono 300mV input, LPF
94dB typ./mono 400mV input, LPF

- High voltage gain : Approximately 13dB (Common FM, AM at standard constants) This gain can be varied by external constants.
- Wide dynamic range : Distortion 1.0%/mono 800mV, 1kHz input (Post amplifier gain : Approximately 13dB)
- The semifixed resistor (pin 4) for separation adjust can be changed to a fixed resistor or can be removed.
- High ripple rejection : 34dB typ.

Package Dimensions

unit:mm

3059-DIP22S

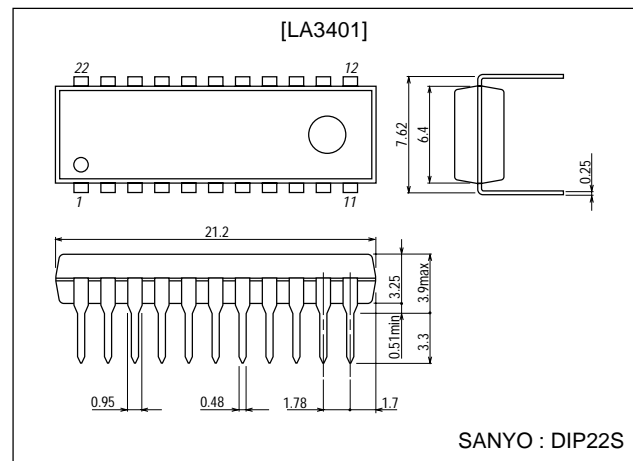

■ Any and all SANYO products described or contained herein do not have specifications that can handle applications that require extremely high levels of reliability, such as life-support systems, aircraft's control systems, or other applications whose failure can be reasonably expected to result in serious physical and/or material damage. Consult with your SANYO representative nearest you before using any SANYO products described or contained herein in such applications.

■ SANYO assumes no responsibility for equipment failures that result from using products at values that exceed, even momentarily, rated values (such as maximum ratings, operating condition ranges, or other parameters) listed in products specifications of any and all SANYO products described or contained herein.

SANYO Electric Co., Ltd. Semiconductor Company

TOKYO OFFICE Tokyo Bldg., 1-10, 1 Chome, Ueno, Taito-ku, TOKYO, 110-8534 JAPAN

12800TH (KT)/41594HK/O077KI/6066KI/6195KI, TS No.1868-1/15

Specifications

Absolute Maximum Ratings at Ta = 25°C

Parameter	Symbol	Conditions	Ratings	Unit
Maximum Supply Voltage	V _{CC} max		16.0	V
Lamp Driving Current	I _L max		30.0	mA
Allowable Power Dissipation	Pd max	Ta≤45°C	620	mW
Operating Temperature	Topr		-20 to +70	°C
Storage Temperature	Tstg		-40 to +125	°C

Operating Conditions at Ta = 25°C

Parameter	Symbol	Conditions	Ratings	Unit
Recommended Supply Voltage	V _{CC}		13.0	V
Recommended Input Signal Voltage	V _i		300 to 400	mV
Operating Voltage Range	V _{CC} op		6.5 to 14.0	V

Operating Characteristics at Ta = 25°C, V_{CC}=13V, f=1kHz, input 400mV, L+R=90%, pilot=10%

Parameter	Symbol	Conditions	Ratings			Unit
			min	typ	max	
Quiescent Current	I _{cco}	Quiescent		25	35	mA
Input Resistance	r _i	FM, AM input	14	20		kΩ
Ripple Rejection of Power Supply				34		dB
Channel Separation	Sep	f=100Hz		45		dB
		f=1kHz	40	55		dB
		f=10kHz		50		dB
Total Harmonic Distortion	THD	Mono		0.01	0.08	%
		Stereo main		0.025	0.1	%
		Stereo sub		0.02	0.1	%
		AM		0.01	0.08	%
Allowable Input Level	V _{in} max	THD=1% (FM mono, AM)	800			mV
S/N		Mono, 300mV, Rg=5.1kΩ, LPF		91		dB
		Mono, 400mV, Rg=5.1kΩ, LPF	80	94		dB
Output Voltage (*1)	V _o	Mono, AM, Input 300mV	802	1162	1545	mV
		Mono, AM, Input 400mV	1070	1550	2060	mV
Channel Balance	CB	Mono, AM			1	dB
Muting Attenuation	Attmute	External mute OFF	70	79		dB
Crosstalk	CT	AM → FM	65	72		dB
		FM → AM	65	72		dB
Mute-ON Voltage	V _{mton}	Pin 15 voltage	3.5		V _{CC} -3	V
Mute-OFF Voltage	V _{mtoff}	Pin 15 voltage			0.3	V
		Pin 10 voltage, AM → FM			0.5	V
FM/AM Changeover Voltage	V _{FM-AM}	Pin 10 voltage, FM → AM	4.3		10	V
					V _{CC} -2	V
		Pin 17 voltage	5.0		V _{CC} -2	V
19kHz Carrier Leak	CL19	De-emphasis		33		dB
38kHz Carrier Leak	CL38	De-emphasis		46		dB
Variation in DC Output Voltage (External mute OFF)		Mono-stereo		35	140	mV
		Mono-mute		15	110	mV
		Stereo-mute		35	140	mV
		AM-mute		15	110	mV
Lamp Lighting Level		Pilot	4	8	17	mV
Lamp Hysteresis				3		dB
Capture Range		Pilot 30mV		±1.2		%

(Note) *1 : The signal voltage after separation adjust is measured.

*2 : The maximum voltage applied to pin 10 (FM/AM changeover voltage) is set to V_{CC}-2V (not exceeding 10V).

*3 : Capture range is defined by :

$$\text{Capture range} = \left(\frac{F_0 - F_1}{F_1} - \frac{F_0 - 456}{456} \right) \times 100 [\%]$$

Where F₀ : Free-running frequency

F₁ : Capture frequency when input frequency is changed.

LA3401

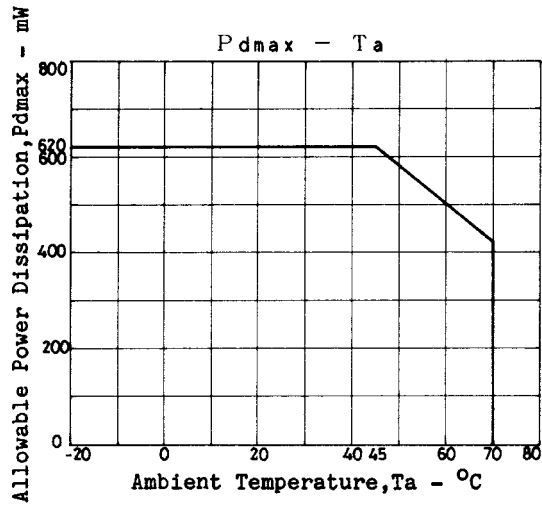

Test Circuit

Unit (resistance: Ω , capacitance: F)

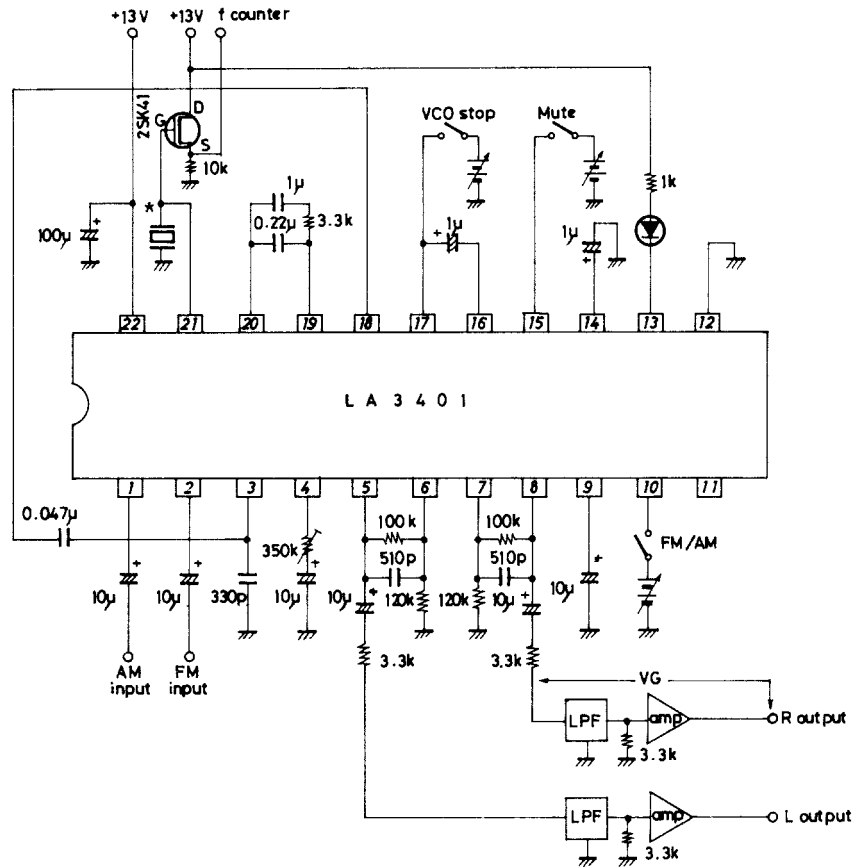

* : CSB456F 11typ (Murata)

LPF : BL-13 (Korin Giken)

amp : THE=0.005% max, V_{N1}=1µV max, band width : 100kHz min, r_i=330kΩ max.

VG : S/N, muting attenuation, crosstalk measurement=50dBmin, Other measurements than above=0dB

LA3401

Sample Application Circuit

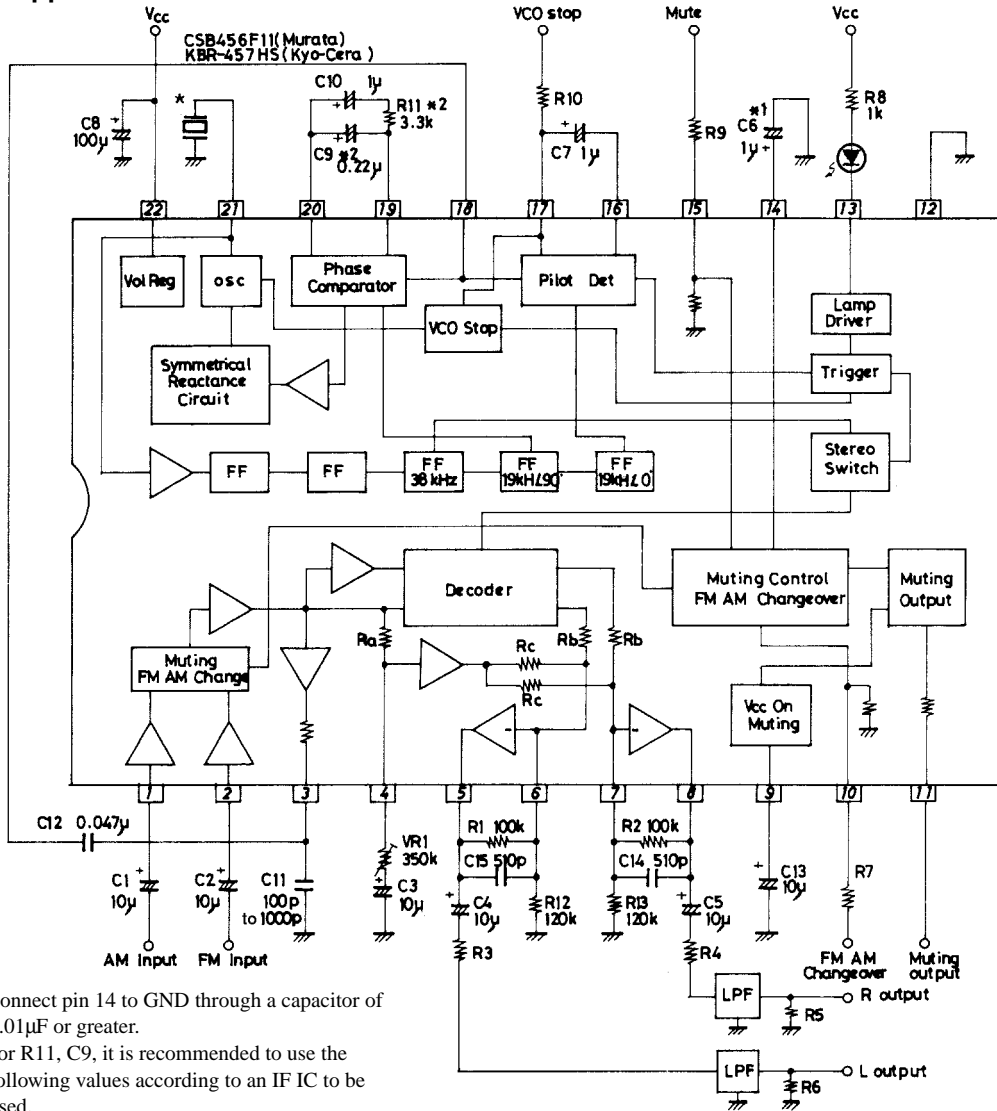

(Note 1) Connect pin 14 to GND through a capacitor of 0.01 μ F or greater.

(Note 2) For R11, C9, it is recommended to use the following values according to an IF IC to be used.

IF IC	R11	C9
LA1235	3.3k	0.22 μ
LA1265, 1230, 1231N	5.6k	0.22 μ
LA1260	10k	0.1 μ

*: CBS456F11 (Murata)
KBR-457HS (Kyocera)

Unit (resistance: Ω , capacitance: F)

Sample Printed Circuit Pattern

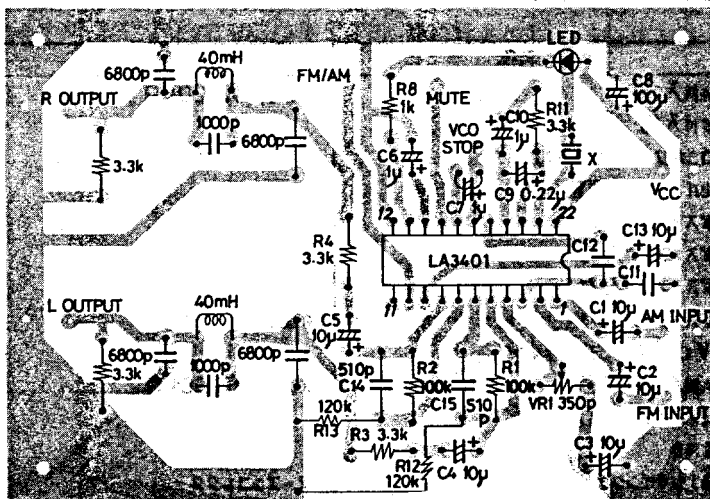

(Cu-foiled area 110 x 75 mm²)

LA3401

External Parts

Part No.	Description	Remarks
C1	DC cut	
C2	DC cut	Decreasing the value worsens separation at low frequencies.
C3	DC cut	Decreasing the value worsens separation at low frequencies.
C4, 5	DC cut	
C6	Time constant for muting at changeover mode	Even when no FM/AM changeover muting is provided, a capacitor of 0.01 μ F or greater is connected.
C7	Sync detect filter	
C8	Power supply ripple filter	
C9	PLL loop filter	A capacitor value from 0.1 to 0.22 μ F is selected according to demodulation output of FM IF. (Note 1)
C10	PLL loop filter	Decreasing the value widens capture range ; increasing the value delays stereo operation start timing after release of VCO stop.
C11	Improvement in low frequency stereo distortion	(L-R) signal and decoder 38kHz switching signal are phased with each other by a capacitor of 100 to 1000pF (differs with each audio set) connected.
C12	DC cut	
C13	Time constant for muting at V _{CC} -ON mode	Output signal is muted for a certain time after application of power.
C14, 15	De-emphasis constant	The values of C14, C15 are determined so that $R1 \cdot C15 = R2 \cdot C14 = 50\mu s$ (75 μs) is yielded.
R1, 2	Post amplifier feedback resistor de-emphasis constant	$R1 \cdot C15 = R2 \cdot C14 = 50\mu s$ (75 μs)
R3, R4	LPF input resistor	3.3k Ω or greater (If less than this, the maximum output voltage cannot be obtained.) Wiring between pin 5 and R3 and between pin 8 and R4 must be made as short as possible.
R5, 6	LPF output resistor	
R7	Limiting resistor	The value of R7 is determined so that voltage applied to pin 10 becomes a value from 4.3V to V _{CC} -2V (not exceeding 10V).
R8	Limiting resistor	Current flowing into pin 13 must not exceed 30mA.
R9	Limiting resistor	The value of R9 is determined so that voltage applied to pin 15 becomes a value from 3.5V to V _{CC} -3V.
R10	Limiting resistor	The value of R10 is determined so that voltage applied to pin 17 becomes a value from 5V to V _{CC} -2V. For how to obtain R10, refer to VCO stop application mentioned later.
R11	Loop filter	A resistor value from 3.3 to 10k Ω is selected according to demodulation output of FM IF (Note 1). Increasing the value widens capture range, but delays stereo operation start timing after release of VCO stop (Note 2).
R12, 13	Output DC voltage setting	Post amplifier output DC voltage. 3.3 (1+R1/R12) or 3.3 (1+R2/R13), extension in output dynamic range.
VR1	Separation adjust	Separation is adjusted by changing (L+R) signal level with VR1.
X	Free-running frequency setting	CSB456F11 (Murata), KBR-457HS (Kyocera)

Note 1 : For C9, R11 setting, refer to Sample Application Circuit (Note 2) and Note 2 for Using IC.

Note 2 : To advance stereo operation start timing, the value of C10 is decreased. Decreasing the value of C10 narrows capture range. This narrowing also depends on the value of C9. It is recommended to use C10 of 0.47 μ F or greater.

Pin Voltage, Name Remarks

Part No.	Voltage [V]	Pin Name	Remarks
1	3.3	AM input	Input resistor 20k Ω
2	3.3	FM input	Input resistor 20k Ω
3	3.3	Composite amplifier output	Output resistor 1k Ω
4	3.3	Separation adjust	
5	3.3	Post amplifier output	L output
6	3.3	Post amplifier input	Minus input
7	3.3	Post amplifier input	Minus input
8	3.3	Post amplifier output	R output
9	3.3	V _{CC} -ON muting	
10	-	FM/AM changeover	Input resistor 80k Ω
11	-	Muting output	
12	0	GND	
13	-	Stereo indicator	Open collector
14	0 or 4.9	Changeover mute	Gnd through a capacitor of 0.01 μ F or greater
15	-	Muting	Input resistor 80k Ω

Continued on next page.

LA3401

Continued from preceding page.

Part No.	Voltage [V]	Pin Name	Remarks
16	2.7	Pilot sync detect filter	
17	2.7	Pilot sync detect filter, VCO stop	
18	2.7	PLL input	
19	2.7	Loop filter	
20	2.7	Loop filter	
21	-	OSC	
22	V _{CC}	Power supply	

Note for Using IC

1. Ceramic resonator

(1) Shown below are ceramic resonators recommended for use in the LA3401.

Type No.	Supplier
CSB456F11	Murata
KBR-457HS	Kyocera

(2) By externally connecting a capacitor in parallel with a ceramic resonator, ceramic resonators shown below can be also used.

Ceramic resonator	Parallel external capacitor
CSB456F10 (Murata)	20pF
KBR-457HS1 (Kyocera)	15pF

2. Capture range and PLL loop filter constants

(1) It is desirable that the capture range, which is related to the stereo distortion, should be set in the range where the capture range does not depend on the pilot level. For example, when the PLL loop filter constants are C9=0.22μF, C10=1μF, R11=3.3kΩ, the capture range characteristic becomes as shown in Fig. 1. For these loop filter constants, it is desirable that the input pilot level should be approximately 20mV or greater where the capture range does not depend on the pilot level. Figs. 2, 3 shows how the capture range characteristic changes with the loop filter constants.

Capture Range Characteristic (1) Fig. 1

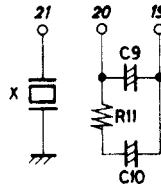
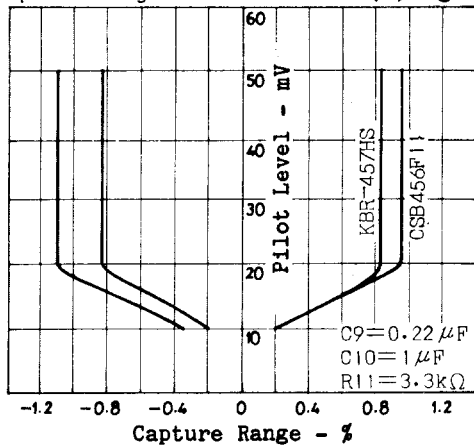

Capture Range Characteristic (2) Fig. 2

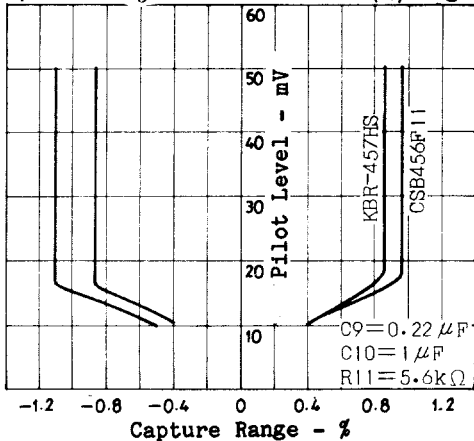

Capture Range Characteristic (3) Fig. 3

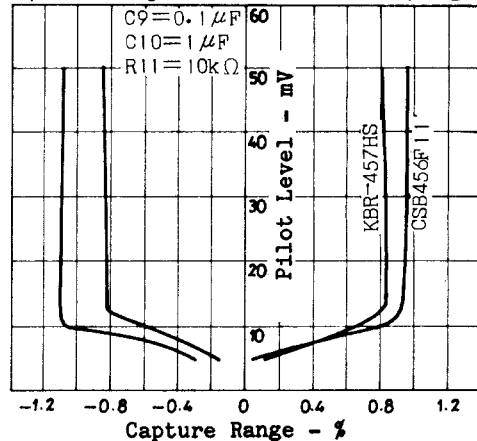

Capture Range Characteristic (4) Fig. 4

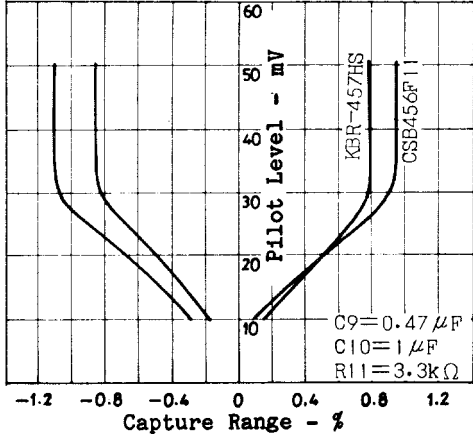

(2) Fig. 5 shows how the capture range changes with loop filter constant R11.

Capture Range Characteristic (5) Fig. 5

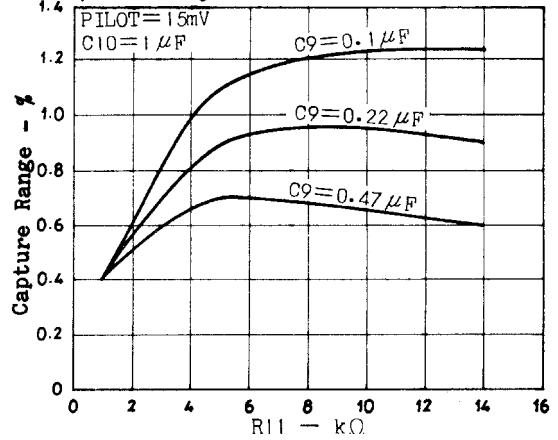

(3) Fig. 6 shows how the distortion of stereo main (L + R) changes with loop filter C9.

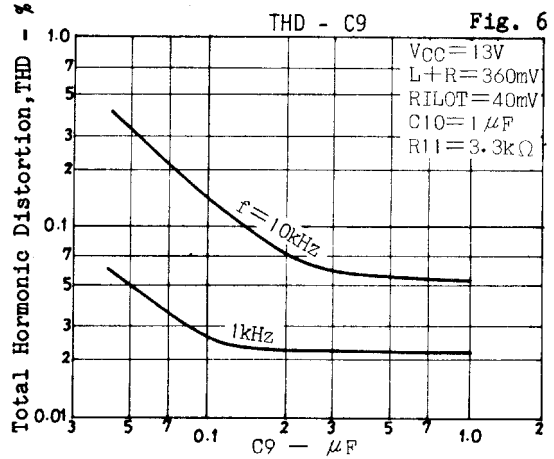

3. VCO stop method

The relation between VCO stop supply V_S and limiting resistor R_S is shown in Fig. 7. R_S must be set so that the voltage on pin 17 is within the specified range when V_S is applied. For example, it is seen from Fig. 7 that the value of R_S is approximately 33kΩ when the voltage on pin 17 is set to 7V at $V_S=12V$. The relation between R_S and the voltage on pin 17 at the VCO stop mode is shown in Fig. 8. The voltage on pin 17 at the VCO stop mode increases with increasing R_S . The lower value on pin 17 is set by adding an increase in the voltage to the minimum value specified.

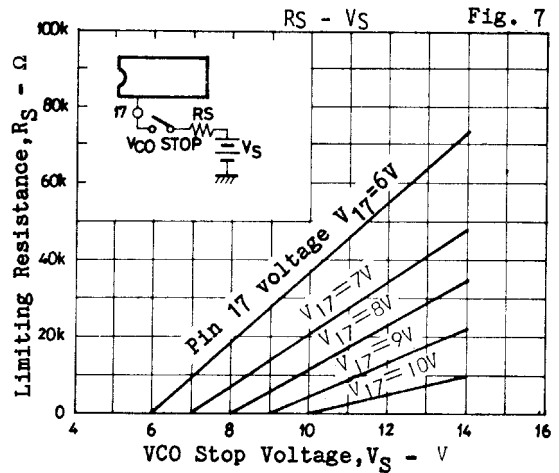

4. Forced monaural mode

To provide the forced monaural mode, pin 16 is connected to GND through a resistor of 10kΩ. In this case, VCO oscillation does not stop.

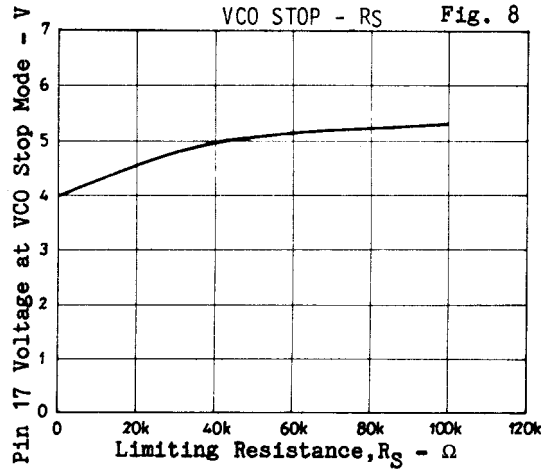

FM/AM mode changeover

(1) How to change over

Changeover is performed by externally applying voltage to pin 10.

FM → AM changeover : Apply a voltage of 4.3V to V_{CC-2} (not exceeding 10V) to pin.

AM → FM changeover : Apply a voltage of 0.5V or less to pin 10.

Fig. 9 shows the relation between the voltage on pin 10 and the flow-in current.

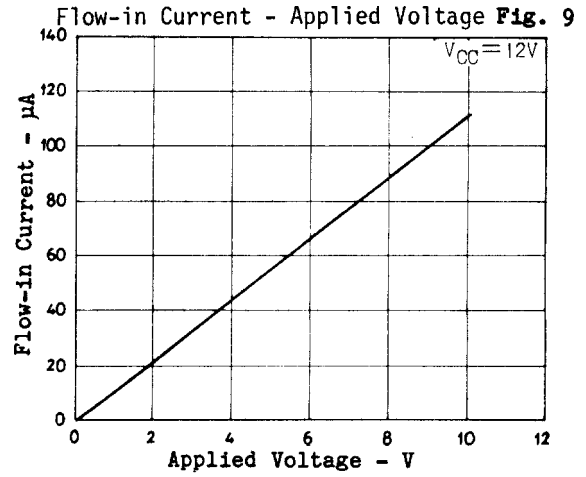

(2) Muting in the changeover mode

Muting is turned ON for a certain period of time fixed by external capacitor C6 in the FM → AM or AM → FM changeover mode (muting in the changeover mode).

Fig. 10 shows the relation between the muting time in the chageover mode and C6.

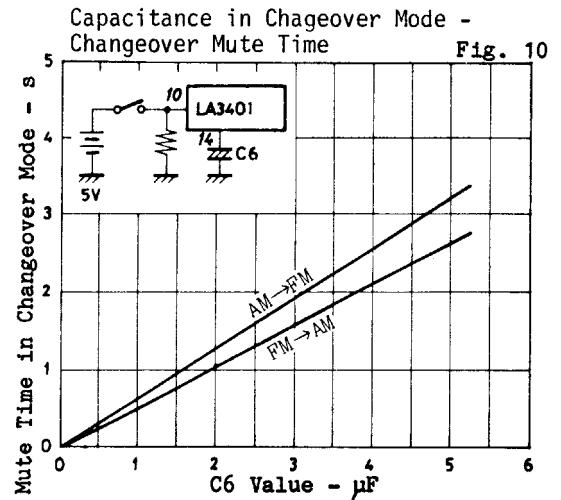

(3) VCO oscillation stop in the AM mode

By externally applying a specified voltage to pin 10 to select the AM mode, VCO oscillation stops automatically and the monaural mode is forced to be entered.

Muting function

(1) How to turn ON/OFF muting

Muting is turned ON/OFF by externally applying voltage to pin 15.

Muting ON : Apply a voltage of 3.5V to V_{CC-3V} to pin 15.

Muting OFF : Apply a voltage of 0.3V or less to pin 15.

Fig. 9 shows the relation between the voltage on pin 15 and the flow-in current.

(2) Hysteresis characteristic

Muting ON/OFF is allowed a hysteresis of approximately 6dB to prevent malfunction attributable to ripple included in the IF meter output, muting drive output.

(3) Forced monaural in the muting mode

By externally applying a specified voltage to pin 15 to select the muting mode, the forced monaural mode is automatically entered.

Muting output

Since the muting signal is delivered at the muting output (pin 11) in the following mode, external transistors can be used to provide external muting.

- ① AM → FM changeover mode (muting in the changeover mode)
- ② Muting mode
- ③ V_{CC}-ON/OFF mode

Fig. 11 shows a sample application of external muting.

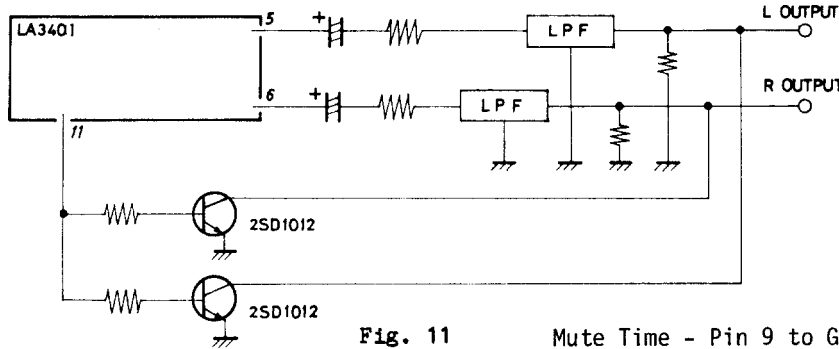

Fig. 11

Muting in the V_{CC}-ON mode

1. Muting time

Muting is turned ON for a certain period of time fixed by external capacitor C13. Fig. 12 shows the relation between the muting time and C13.

Mute Time - Pin 9 to GND Capacitance Fig. 12

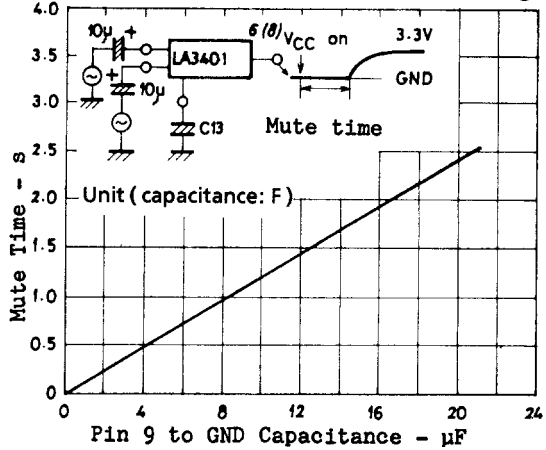

2. Values of AM/FM input coupling capacitors (C1, C2) and value of C13

If muting is released before the DC voltage on the AM input (pin 1) or FM input (pin 2) is stabilized after V_{CC} is turned ON, pop noise is generated. Therefore, the value of C13 must be determined by the input coupling capacitor value. The adequate value of C13 for C1, C2 of 10µF is 10µF or thereabouts. If the value of C1, C2 is increased, the value of C13 is also increased accordingly.

Feedback resistance of post amplifier and total gain, de-emphasis constant values

Table 1 shows the feedback resistance of post amplifier and total gain, de-emphasis

Table 1. Feedback resistance of post amplifier and total gain, de-emphasis

R1 (R2)	Total	C13 (C14) 50µs	C13 (C14) 50ms
33kΩ	3.0dB	1500pF	2200pF
39kΩ	4.5dB	1200pF	2000pF
51kΩ	6.5dB	1000pF	1500pF
62kΩ	8.5dB	750pF	1200pF
82kΩ	11.0dB	620pF	910pF
100kΩ	13.0dB	510pF	750pF
130kΩ	15.0dB	390pF	560pF
150kΩ	16.0dB	330pF	510pF
180kΩ	17.5dB	270pF	390pF

Total gain : Value in monaural mode

$$R1 \cdot C15 = R2 \cdot C14 = 50\mu s, 75\mu s$$

How to extend the dynamic range of the post amplifier

In the Sample Application Circuit of the LA3401 the dynamic range of the post amplifier is extended by connecting resistors R12, R13 across the virtual GND points (pins 6, 7) of the post amplifier and GND as shown in Fig. 13 to set the output (pins 5, 8) DC voltages to an adequate value.

The DC voltages on pins 5, 8 are obtained as follows :

$$3.3 \left(\frac{R_B + R1}{R_B} \right) = 3.3 \left(1 + \frac{R1}{R_B} \right)$$

$$3.3 \left(\frac{R_B + R2}{R_B} \right) = 3.3 \left(1 + \frac{R2}{R_B} \right)$$

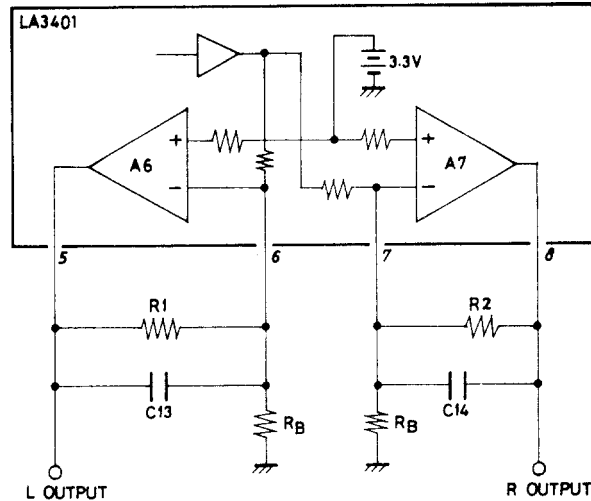

Fig. 13

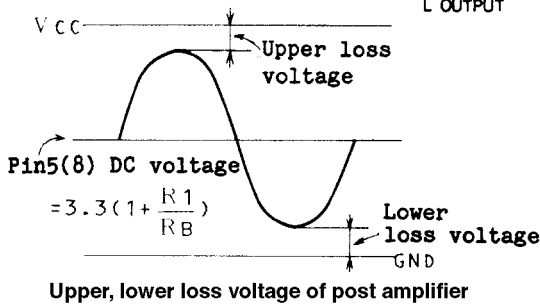

Fig. 14

The upper and lower loss voltages of the post amplifier output are approximately 2V and 0.5V respectively as shown in Fig. 14. With these loss voltages considered, the voltages on pins 5, 8 are set.

In the Sample Application Circuit the voltages on pins 5, 8 are set to 6V and the maximum output voltage is obtained at $V_{CC}=13V$.

The Sample Application Circuit provides the reduced voltage characteristic at approximately 9V. If the reduced voltage characteristic at approximately 6V is required, remove R12, R13 shown in the Sample Application Circuit. Then, the output (pins 5, 8) DC voltages becomes approximately 3.3V and the reduced voltage characteristic becomes as shown in Fig. 15. Fig. 15 shows the THD vs. V_{CC} characteristic, but other characteristics such as separation are also available at $V_{CC}=6V$ by removing R12, R13.

Low-pass filter

Fig. 16 shows a sample circuit configuration where an LC filter is used as the low-pass filter and Fig. 17 shows a sample characteristic of this filter. As compared with the LPF (BL-13) in the Sample Application Circuit, the use of this filter makes the attenuation less at 19kHz, 38kHz : therefore, carrier leak at the LPF output causes the stereo distortion and separation characteristic to get worse than specified in the Operating Characteristics. For the stereo distortion, the BL-13 provides approximately 0.02%, while the LC filter provides approximately 0.5%.

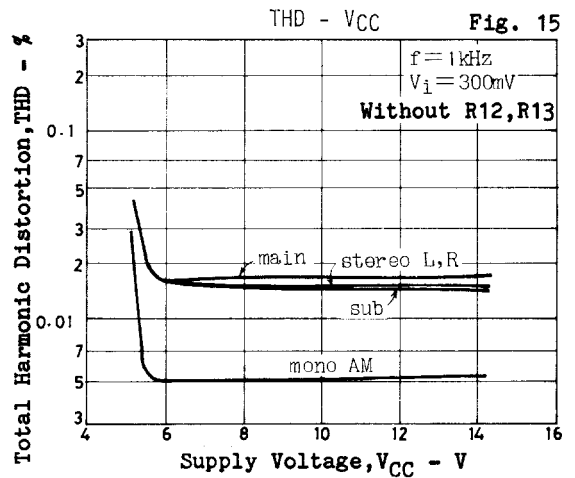

LA3401

Unit (resistance: Ω , capacitance: F)

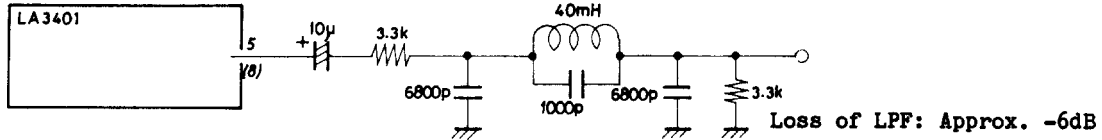
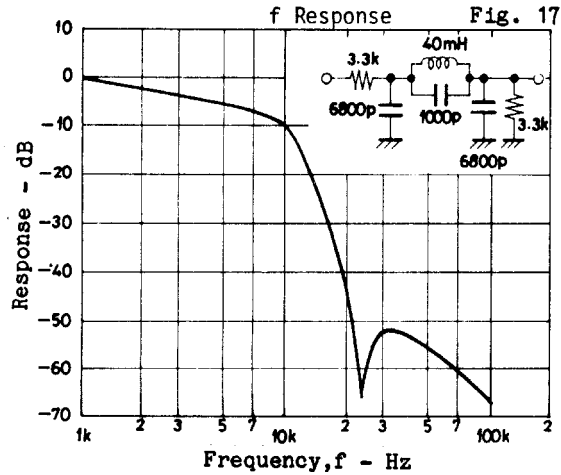

Fig. 16 Sample LC filter circuit (including de-emphasis circuit)



Decoder circuit (Refer to the Block Diagram in the Sample Application Circuit.)

The LA3401 adopts a decoder circuit of chopper type. The sub signal syncdetected by this decoder is applied to the post amplifier minus input through R_b as shown in the Sample Application Circuit. This signal is matrixed with the main signal coming out of amplifier A5 and passing through R_c .

The gain for the sub signal is :

$$V_S \frac{R_1}{R_b} \cdot \frac{2}{\pi} \text{ or } V_S \frac{R_2}{R_b} \cdot \frac{2}{\pi}$$

R_1, R_2 : Post amplifier feedback resistor

V_S : Peak value of input sub signal

The gain for the main signal is :

$$V_M \frac{VR_1}{R_a + VR_1} \cdot \frac{R_1}{R_c} \text{ or } V_M \frac{VR_1}{R_a + VR_1} \cdot \frac{R_2}{R_c}$$

VR_1 : Semifixed resistor for separation adjust

V_M : Peak value of input main signal

In the LA3401, the gain of the main signal is varied with VR_1 to adjust the separation. Since the IF output is generally such that the sub signal level is lower than the main signal level, the separation can be adjusted by attenuating the main signal level with VR_1 . The use of an antibirdie filter across the IF output and the FM input of the LA3401 may cause the sub signal level to be raised, and when the sub signal level is higher than the main signal level the separation cannot be adjusted with VR_1 . In this case, the sub signal level is attenuated to be less than the main signal level and applied to the LA3401 and the separation is adjusted with VR_1 .

LA3401

Unit (resistance: Ω , capacitance: F)

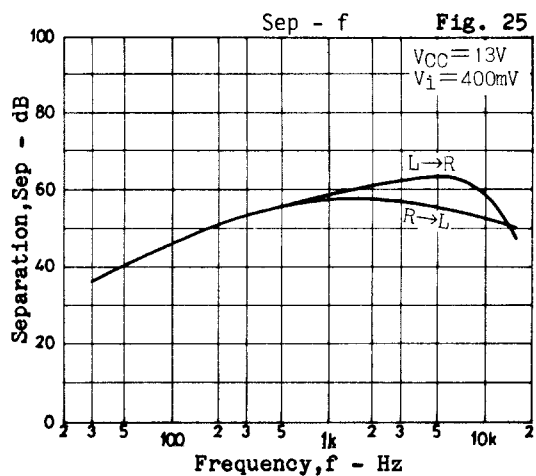
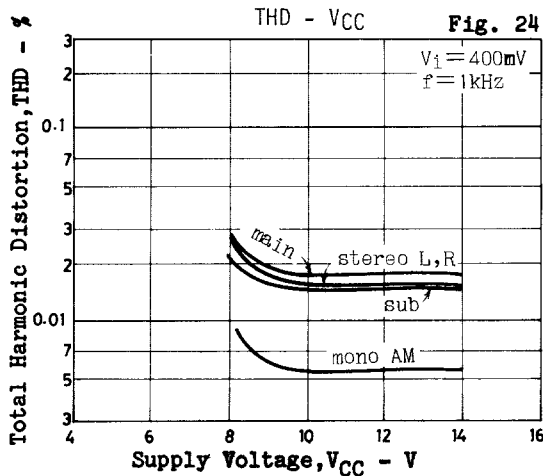
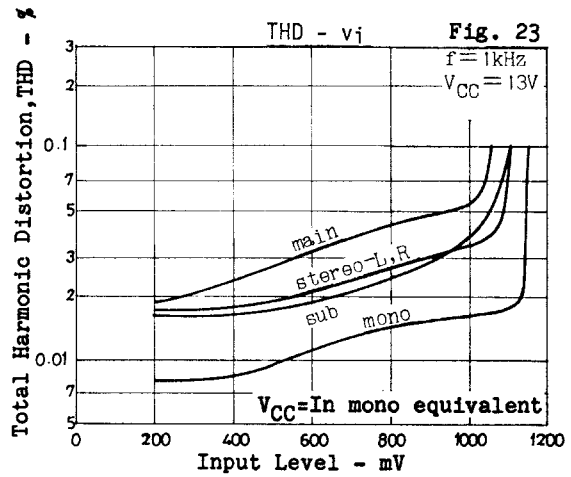
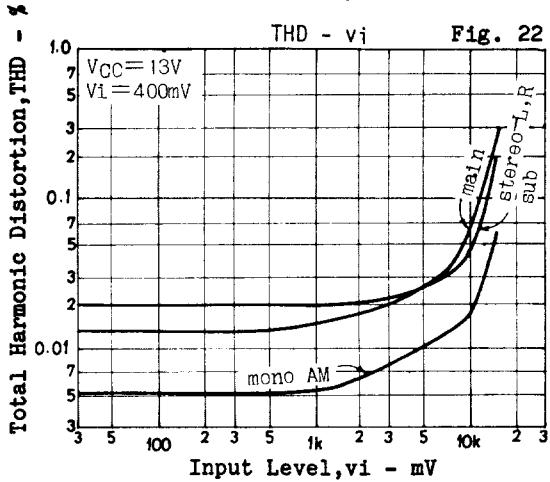
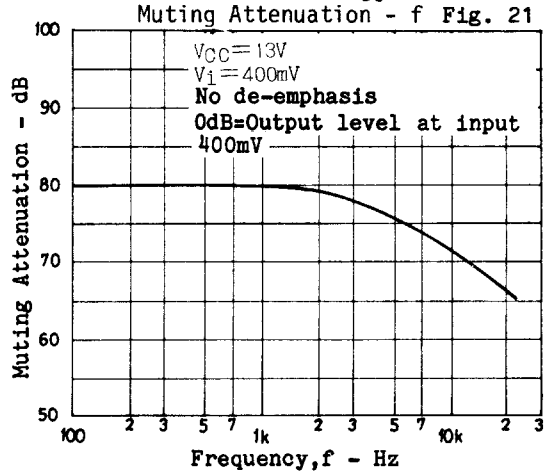
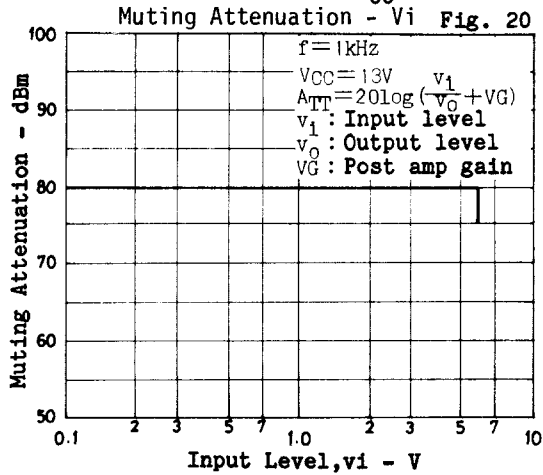
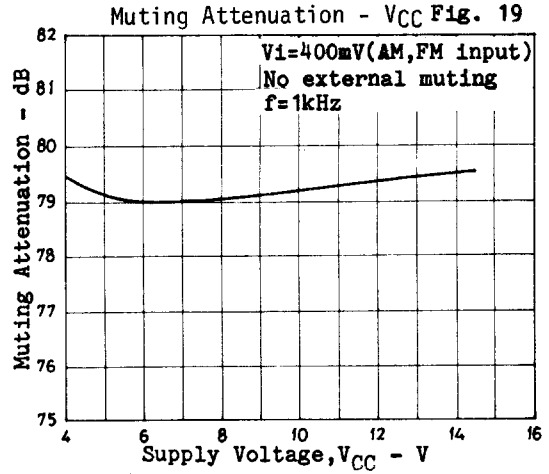
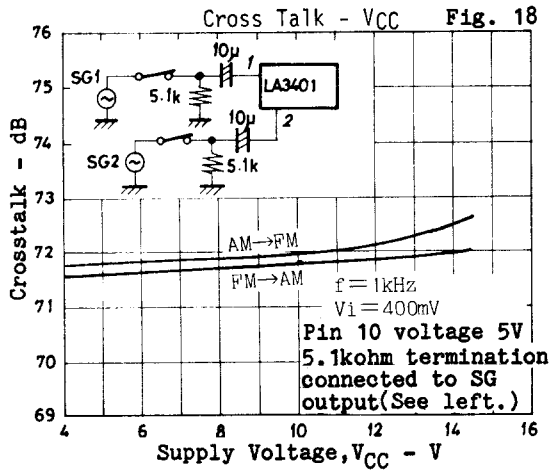

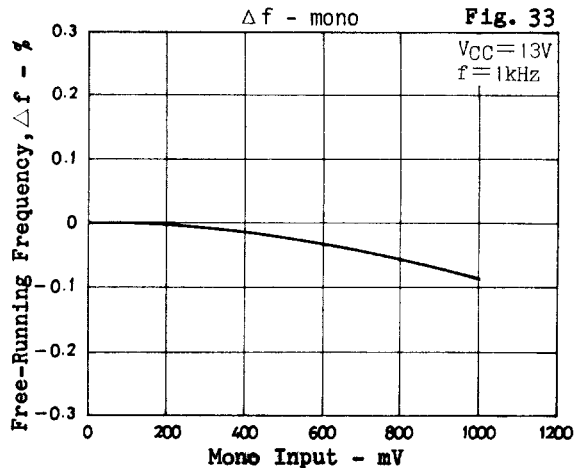
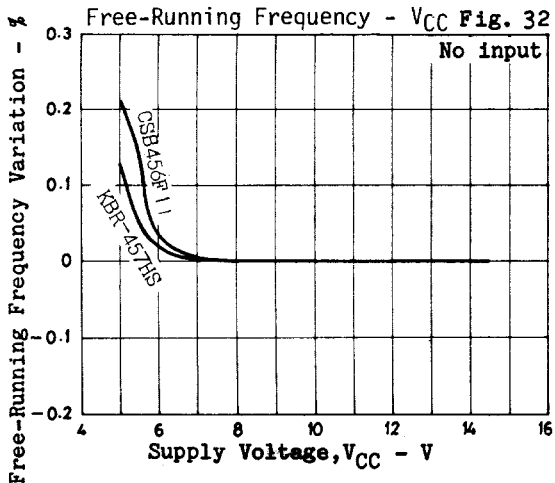
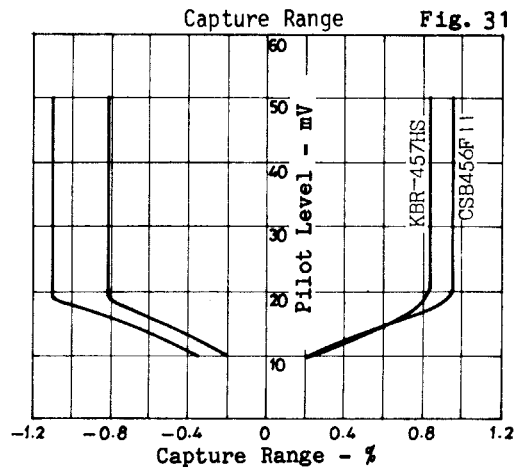
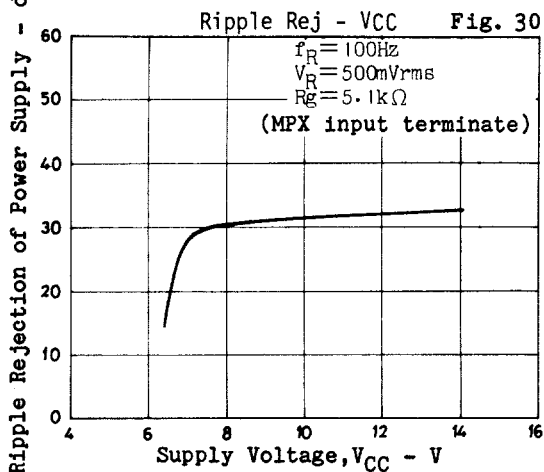
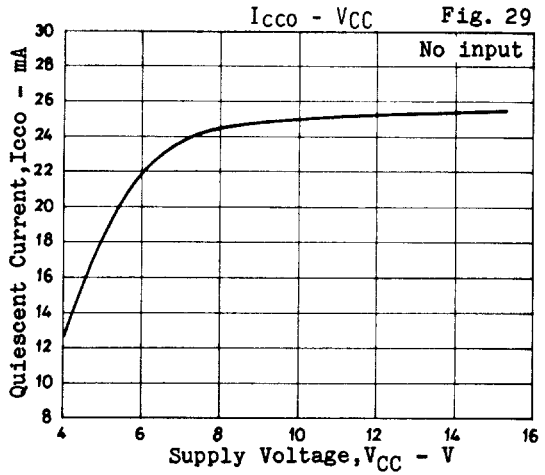
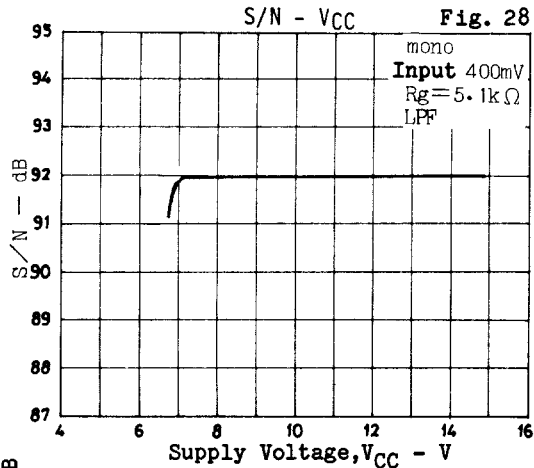
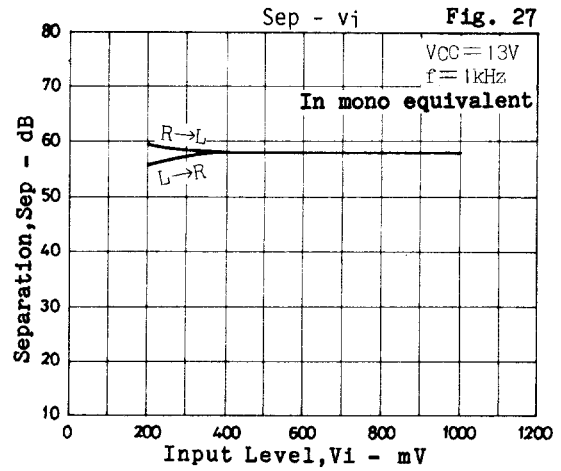
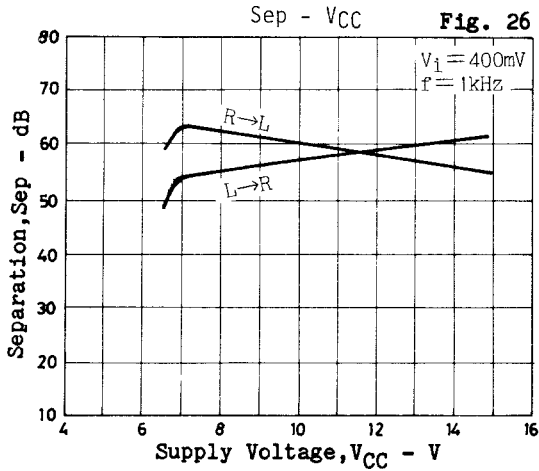

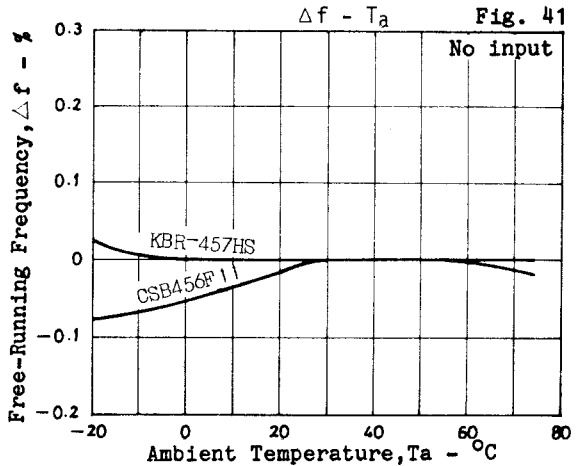
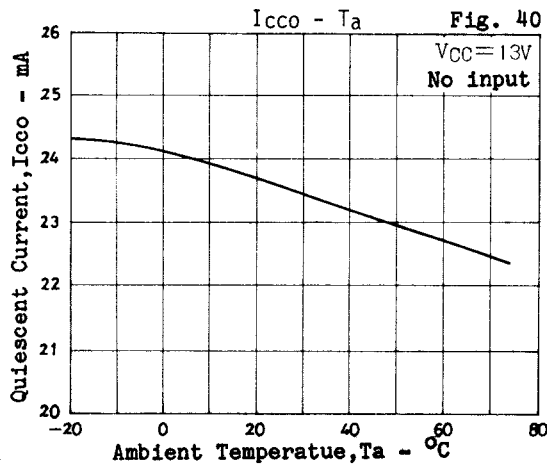
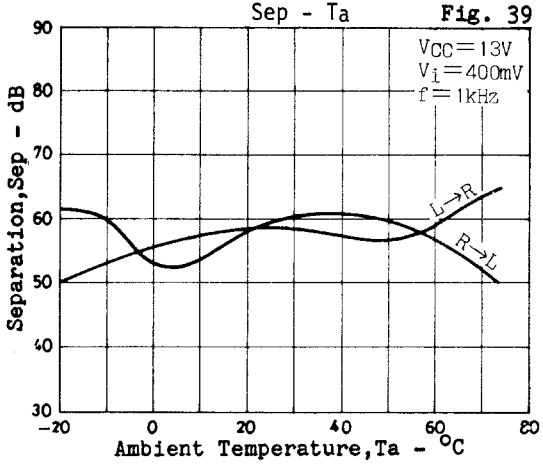
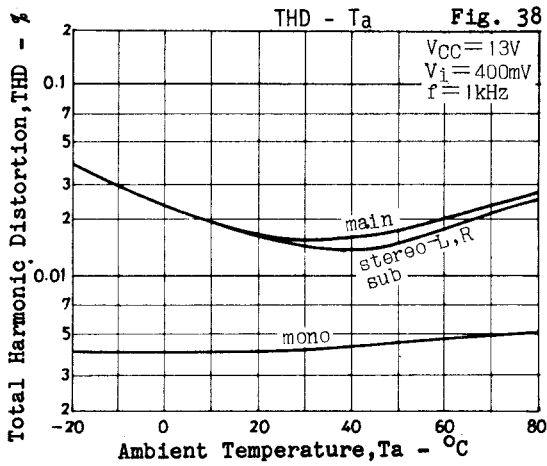
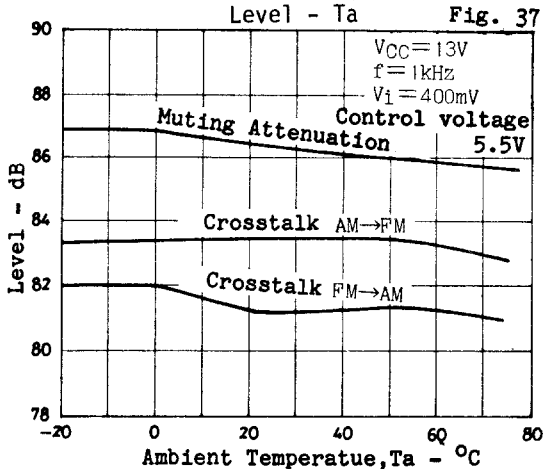
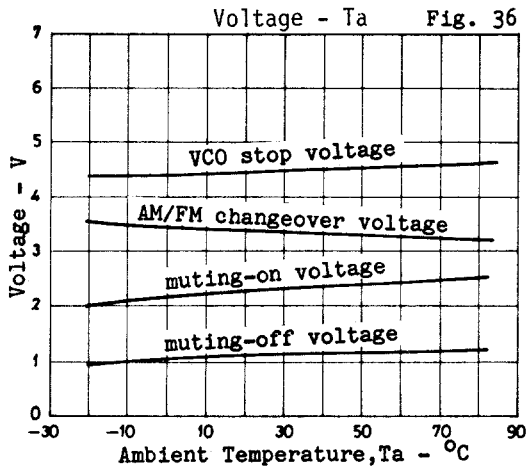
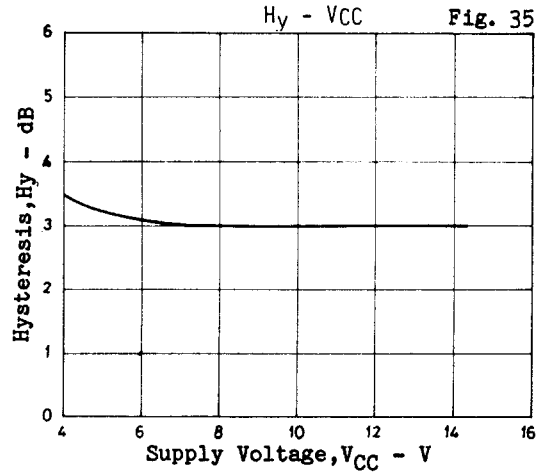
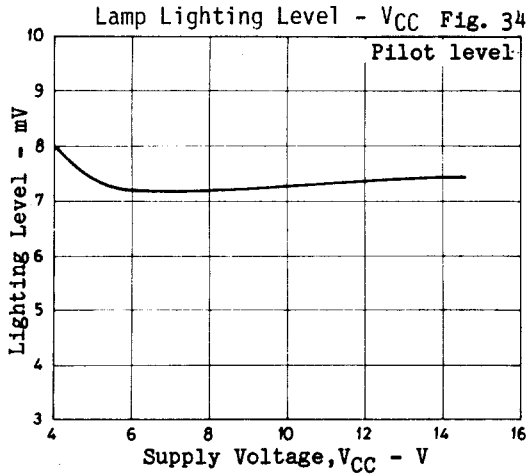

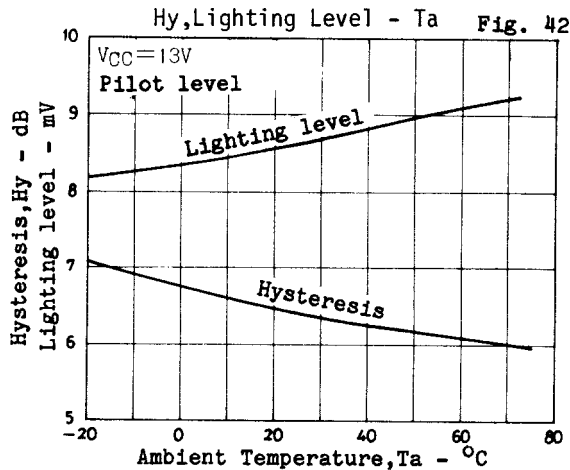

- Specifications of any and all SANYO products described or contained herein stipulate the performance, characteristics, and functions of the described products in the independent state, and are not guarantees of the performance, characteristics, and functions of the described products as mounted in the customer's products or equipment. To verify symptoms and states that cannot be evaluated in an independent device, the customer should always evaluate and test devices mounted in the customer's products or equipment.
- SANYO Electric Co., Ltd. strives to supply high-quality high-reliability products. However, any and all semiconductor products fail with some probability. It is possible that these probabilistic failures could give rise to accidents or events that could endanger human lives, that could give rise to smoke or fire, or that could cause damage to other property. When designing equipment, adopt safety measures so that these kinds of accidents or events cannot occur. Such measures include but are not limited to protective circuits and error prevention circuits for safe design, redundant design, and structural design.
- In the event that any or all SANYO products (including technical data, services) described or contained herein are controlled under any of applicable local export control laws and regulations, such products must not be exported without obtaining the export license from the authorities concerned in accordance with the above law.
- No part of this publication may be reproduced or transmitted in any form or by any means, electronic or mechanical, including photocopying and recording, or any information storage or retrieval system, or otherwise, without the prior written permission of SANYO Electric Co., Ltd.
- Any and all information described or contained herein are subject to change without notice due to product/technology improvement, etc. When designing equipment, refer to the "Delivery Specification" for the SANYO product that you intend to use.
- Information (including circuit diagrams and circuit parameters) herein is for example only; it is not guaranteed for volume production. SANYO believes information herein is accurate and reliable, but no guarantees are made or implied regarding its use or any infringements of intellectual property rights or other rights of third parties.

This catalog provides information as of January, 2000. Specifications and information herein are subject to change without notice.