



LA7282, 7282M

VCR Audio Signal Recording / Playback Processor

Overview

The LA7282 and 7282M are small package ICs containing all functions necessary to record and playback VCR audio signal.

Features

- Small package leaves large space for other components.
- Delete of In and Output electrolysis capacitor.
- Low capacitor (0.1 μ F) for the line amplifier inputs (PB IN and AUDIO IN)
- Non-Adjustment of PB Gain by less gain scatter.

Package Dimensions

unit:mm

3067A-DIP24S

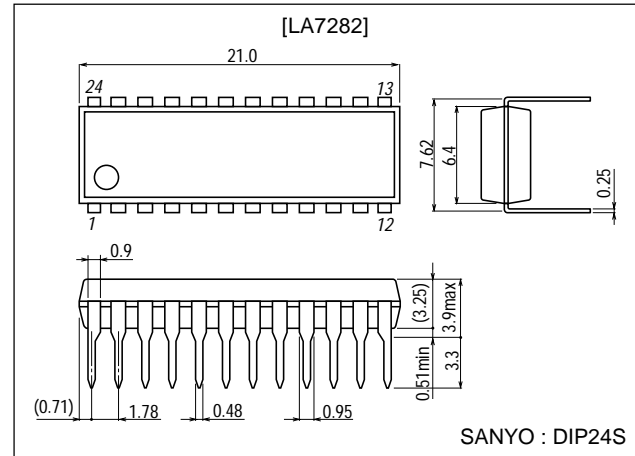

unit:mm

3112A-MFP24S

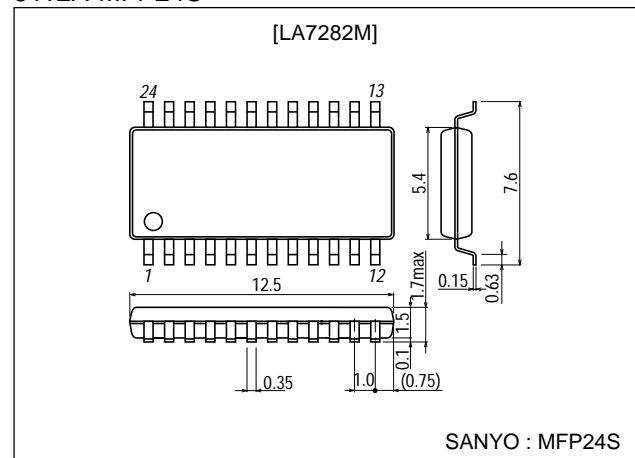

■ Any and all SANYO products described or contained herein do not have specifications that can handle applications that require extremely high levels of reliability, such as life-support systems, aircraft's control systems, or other applications whose failure can be reasonably expected to result in serious physical and/or material damage. Consult with your SANYO representative nearest you before using any SANYO products described or contained herein in such applications.

■ SANYO assumes no responsibility for equipment failures that result from using products at values that exceed, even momentarily, rated values (such as maximum ratings, operating condition ranges, or other parameters) listed in products specifications of any and all SANYO products described or contained herein.

SANYO Electric Co.,Ltd. Semiconductor Company

TOKYO OFFICE Tokyo Bldg., 1-10, 1 Chome, Ueno, Taito-ku, TOKYO, 110-8534 JAPAN

LA7282, 7282M

Specifications

Maximum Ratings at Ta = 25°C

Parameter	Symbol	Conditions	Ratings	Unit
Maximum supply voltage	V _{CC} max		14	V
Pin 1 input voltage	V _{IN1}	Ta=65°C, f=80kHz (sin), I _{LK} =10μA	90 (±45)	Vp-p
Pin 1 input current	I _{IN1}		±1.5	mA
Allowable power dissipation	Pd max	Ta≤65°C, when mounted on the recommended PCB	400	mW
Operating temperature	Topr		-10 to +65	°C
Storage temperature	Tstg		-55 to +125	°C

Operating Conditions at Ta = 25°C

Parameter	Symbol	Conditions	Ratings	Unit
Recommended supply voltage	V _{CC}		12.0	V
Operating voltage range	V _{CC} op		11.25 to 12.75	V

Operating Characteristics at Ta = 25°C, V_{CC}=12V, f=1kHz, 0dBv = : 1.0Vrms

Parameter	Symbol	Conditions	Ratings			Unit
			min	typ	max	
Current drain (FE)	I _{CCE}	Quiescent	8.0	12.0	17.0	mA
Current drain (PB)	I _{CCP}	Quiescent	9.0	13.0	18.0	mA
Current drain (REC)	I _{CCR}	Quiescent	7.0	10.0	14.0	mA
Overall gain at PB mode	V _G PB	EQ IN-LINE OUT, V _O =-5dBv	59.0	59.5	60.0	dB
[Equalizing amplifier]						
Open loop voltage gain	V _G OE	V _O =-5dBv	66.0	71.0		dB
Equivalent input noise voltage	V _N IE	Rg=2.2kΩ, DIN audio filter		1.2	1.8	μVrms
Input impedance	Z _I NE			130		kΩ
[Line amplifier]						
Voltage gain (PB IN)	V _G LP	V _O =-5dBv	21.0	21.5	22.0	dB
Voltage gain (EE, REC IN)	V _G LR	V _O =-5dBv	21.0	21.5	22.0	dB
Total harmonic distortion	THD _L	V _O =-5dBv		0.3	0.5	%
Output noise voltage	V _N OL	DIN audio filter		-70.0	-64.0	dBv
Input impedance (PB IN)	Z _I IN1			120		kΩ
Input impedance (EE, REC IN)	Z _I IN2			120		kΩ
Maximum output voltage	V _O ML	THD=3%	1.5	2.1		Vrms
Output voltage at ALC	V _O OA	V _I N=-28dBv	-9.0	-8.0	-7.0	dBv
ALC Effect	ALC	V _I N=-28 to -8dBv		1.5	3.0	dB
Total harmonic distortion at ALC	THD _A	V _I N=-28dBv		0.25	0.6	%
[Recording amplifier]						
Voltage gain (open loop)	V _G OR	V _O =-5dBv	47.0	52.0		dB
Voltage gain (closed loop)	V _G CR	V _O =-5dBv	12.5	13.0	13.5	dB
Total harmonic distortion	THD _R	V _O =-5dBv		0.1	0.3	%
Input impedance	Z _I NR			50		kΩ
Maximum output voltage	Z _O MR	THD=3%	1.5	2.0		Vrms
[Muting circuit]						
On voltage	V _M ON	Pin 22, DC	3.8		6.0	V
Off voltage	V _M OFF	Pin 22, DC	0		1.0	V
Mute attenuation level (PB, EE)	M _P , M _E		80.0	90.0		dB
Mute attenuation level (REC)	M _R		65.0	70.0		dB
[PB/EE selector circuit]						
PB mode hold voltage	V _P PP	Pin 23, DC	0		1.0	V
EE mode hold voltage	V _P PE	Pin 23, DC	3.3		6.0	V
[REC/EE selector circuit]						
REC mode hold voltage	V _R RR	Pin 24, DC	3.3		V _{CC}	V
EE mode hold voltage	V _R RE	Pin 24, DC	0		1.0	V
[Equalizer selector circuit]						
Switch on voltage	V _E ON	Pin 20, 21, DC	3.5		6.0	V
Switch off voltage	V _E OFF	Pin 20, 21, DC	0		0.8	V
[Head selector switch]						
Pin 1 on resistance	R _O N1	I1=±1mA		15	30	Ω
Pin 2 on resistance	R _O N2	I2=±1mA		5	10	Ω
Pin 1 input voltage	V _I N1	Ta=65°C, f=80kHz (sin), I _{LK} =10μA			±45	V

LA7282, 7282M

Block Diagram

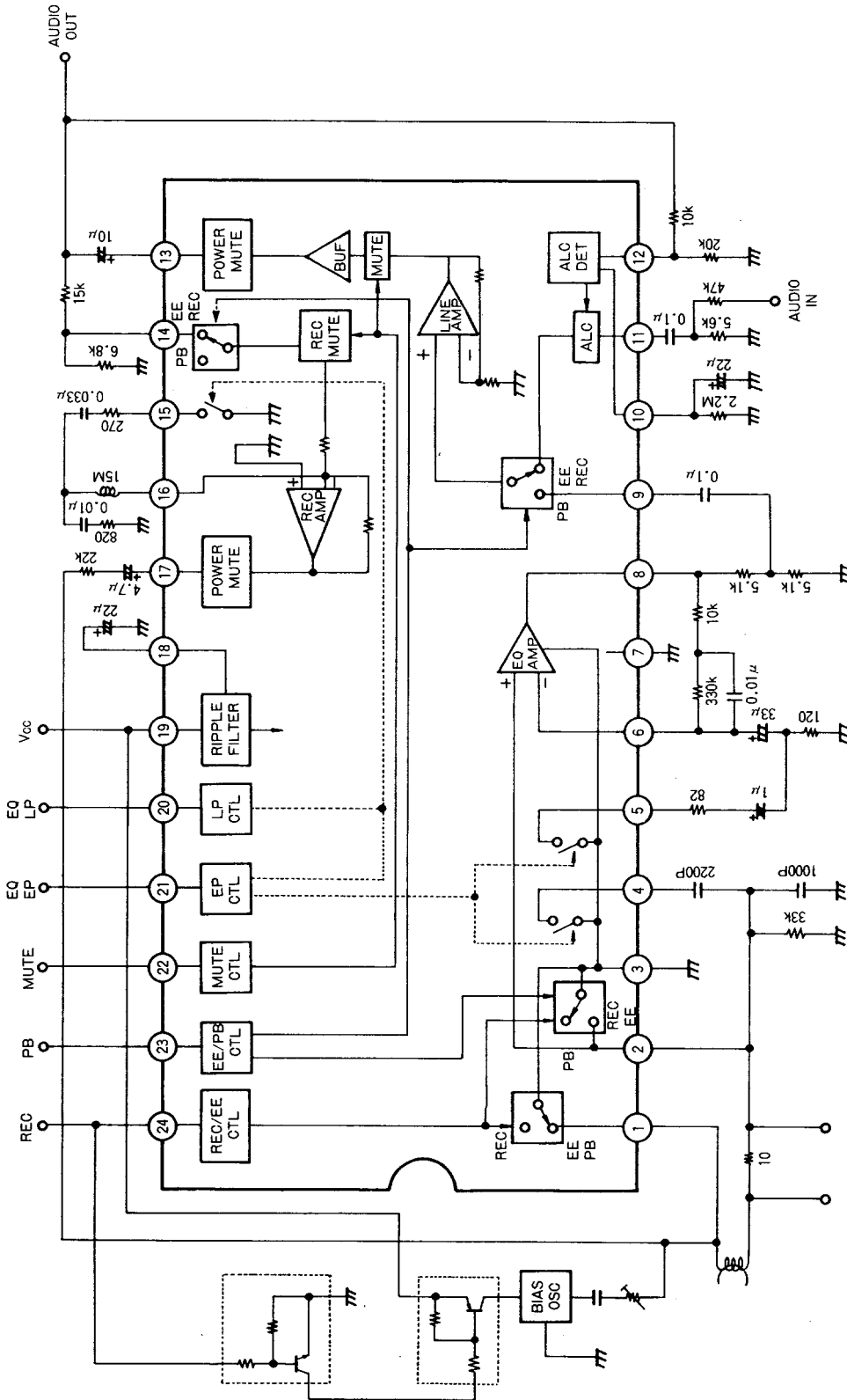

Unit (resistance : Ω, capacitance : F)

LA7282, 7282M

Test Circuit

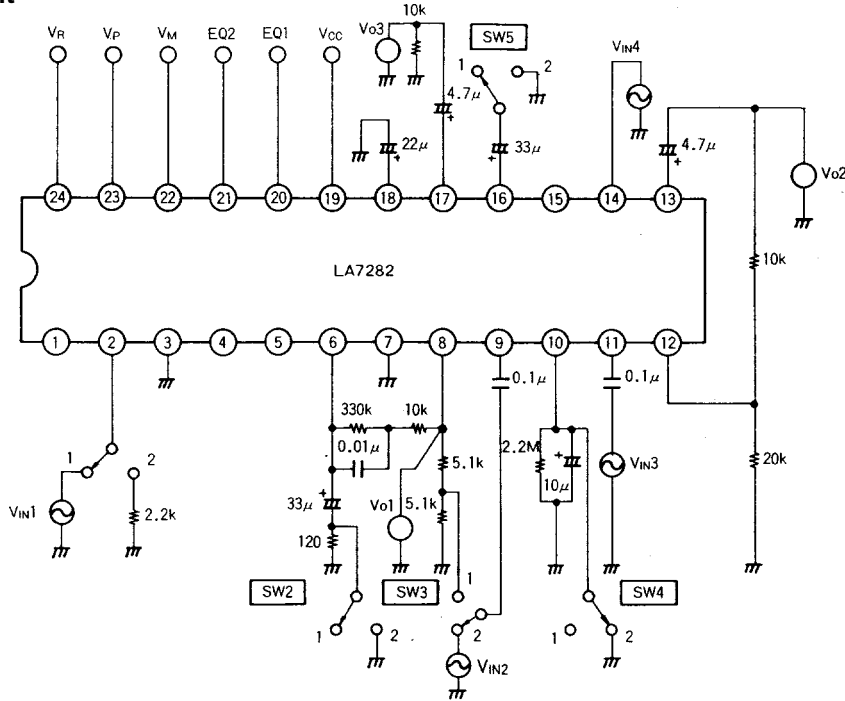

Unit (resistance : Ω , capacitance : F)

<Switch Setting Table>

Parameter (Symbol)	SW1	SW2	SW3	SW4	SW5	V _M	V _P	V _R	Input	Measurement
I _{CCE}	2	1	1	2	1	GND	5V	GND	-	A
I _{CCP}	2	1	1	2	1	GND	GND	GND	-	A
I _{CCR}	2	1	1	2	1	GND	5V	5V	-	A
V _{GPB}	1	1	1	2	1	GND	GND	GND	V _{IN1}	V _{O2}
V _{GOE}	1	2	2	2	1	GND	GND	GND	V _{IN1}	V _{O1}
V _{NIE}	2	1	2	2	1	GND	GND	GND	-	V _{O1}
V _{GLP} , THD _L , V _{OML}	2	1	2	2	1	GND	GND	GND	V _{IN2}	V _{O2}
V _{GLR}	2	1	1	2	1	GND	5V	GND	V _{IN3}	V _{O2}
V _{NOL}	2	1	2	2	1	GND	5V	GND	-	V _{O2}
V _{OA} , ALC, THD _A	2	1	2	1	1	GND	5V	GND	V _{IN3}	V _{O2}
V _{GOR}	2	1	2	2	2	GND	5V	GND	V _{IN4}	V _{O3}
V _{GCR} , THDR, V _{OMR}	2	1	2	2	1	GND	5V	GND	V _{IN4}	V _{O3}
M _P	1	1	1	2	1	5V	GND	GND	V _{IN1}	V _{O2}
M _R	2	1	1	2	1	5V	5V	GND	V _{IN4}	V _{O3}
M _E	2	1	2	2	1	5V	5V	GND	V _{IN2}	V _{O2}

Pin Assignment

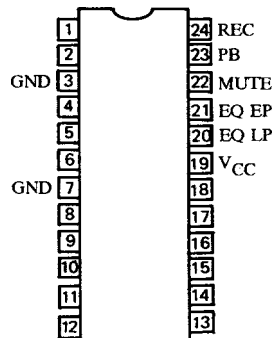

Top view

LA7282, 7282M

Pin Functions

Unit (resistance : Ω)

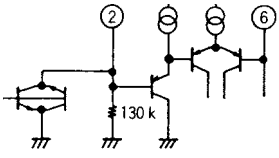
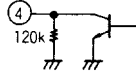
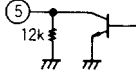
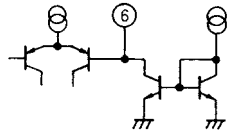
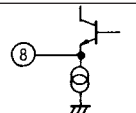
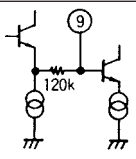
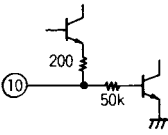
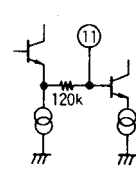
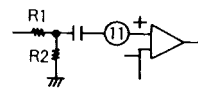
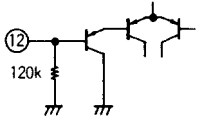
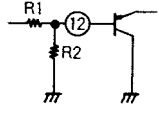
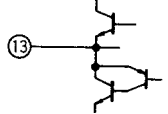
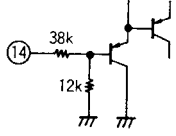
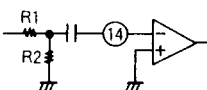
Pin No.	Function	Terminal Circuit	Description
1	Head Switch 1 (High voltage)		EE, PB : on ; REC : off On resistance : 10Ω , type. With stand voltage during off : $\pm 45V$ ($f=80kHz$)
2	EQ AMP Input and Head Switch 2		Input playback signal to the head. Input impedance : $130k\Omega$, typ. EE, REC : on ; PB : off Switch on resistance : 5Ω , typ.
3	GND		An exclusive GND for pin 1 head switch 1, EQ AMP and playback EP switch.
4	EP Switch 1		Sets the tape head resonant frequency. On resistance : 15Ω typ. Input impedance : $120k\Omega$, typ. (playback EP mode)
5	EP Switch 2		Increases the voltage gain at higher frequencies by reducing negative feedback amount of the PB EQ AMP. On resistance : 15Ω , typ. Input impedance : $12k\Omega$, typ. (playback EP mode)
6	EQ AMP NFB		Input of negative feedback of the EQ AMP to establish desired equalizing characteristics.
7	GND		Common return for all circuits except for EQ AMP and head switch 1.
8	EQ AMP Output		
9	LINE AMP PB Input		Input PB signal to the EQ AMP. The input impedance of pin 9 is high ($120k\Omega$) and requires a small coupling capacitor of $0.1\mu F$.
10	ALC FILTER		Connecting this pin to GND through a capacitor enables detection. The RC time constant sets attack recovery time.
11	LINE AMP Audio Input		Input EE, REC signal.  Select value of R_1 and R_2 so that the reference input is at the shoulder of the ALC. The amplifier gain should be set for 21.5dB. The input impedance of pin 11 is high ($120k\Omega$) and requires a small coupling capacitor of $0.1\mu F$.
12	ALC Detect Input		 Accepts the output signal of LINE amplifier. The ALC level is determined by the voltage divider consisting of R_1 and R_2 .
13	LINE AMP Output		Output impedance : 50Ω , typ.
14	REC AMP Input		Input recording signal from LINE AMP.  Input current is set by the divider consisting of R_1 and R_2 . Pin 14 requires no coupling capacitor since REC AMP is to operate at zero level and as inverting amplifier.

Continued on next page.

LA7282, 7282M

Continued from preceding page.

Unit (resistance : Ω)

Pin No.	Function	Terminal Circuit	Description																								
15	LP Switch		Sets the high peaking point to the frequency suitable for LP. On resistance : 15 Ω typ. Input impedance : 60k Ω typ.																								
16	REC AMP NFB		Connecting an L, C, R network to this pin causes a peaking frequency to rise.																								
17	REC AMP Output		Output impedance : 40 Ω typ.																								
18	Ripple Filter		Connecting a electrolytic capacitor across this pin and GND smoothes ripples.																								
19	Supply Voltage (VCC)		VCC=15V max VCC=11.25 - 12.75V typ.																								
20	LP Control		Applying 3.5V DC or more (6.0V max) to this pin turns on LP switch (pin 15). The switch turns off at 0.8V or below.																								
21	EP Control		Applying 3.5V DC or more (6.0V max.) to this pin turns on EP switch (pin 4, 5) and LP switch (pin 15). The switches turn off at 0.8V or below.																								
22	MUTE Control		Applying 3.8V DC or more (6.0V max.) to this pin turns on mute circuit. The mute is disabled at 1.0V or below. [Control mode]																								
			<table border="1" style="margin-left: auto; margin-right: auto; border-collapse: collapse; text-align: center;"> <thead> <tr> <th rowspan="2">Mode</th> <th colspan="2">MUTE [L]</th> <th colspan="2">MUTE [H]</th> </tr> <tr> <th>LINE AMP</th> <th>REC AMP</th> <th>LINE AMP</th> <th>REC AMP</th> </tr> </thead> <tbody> <tr> <td>PB Mode</td> <td>○</td> <td>×</td> <td>×</td> <td>×</td> </tr> <tr> <td>EE Mode</td> <td>○</td> <td>○</td> <td>×</td> <td>×</td> </tr> <tr> <td>REC Mode</td> <td>○</td> <td>○</td> <td>○</td> <td>×</td> </tr> </tbody> </table> <p style="text-align: center;">[○ : Pass signal, × : Block signal]</p>	Mode	MUTE [L]		MUTE [H]		LINE AMP	REC AMP	LINE AMP	REC AMP	PB Mode	○	×	×	×	EE Mode	○	○	×	×	REC Mode	○	○	○	×
Mode	MUTE [L]		MUTE [H]																								
	LINE AMP	REC AMP	LINE AMP	REC AMP																							
PB Mode	○	×	×	×																							
EE Mode	○	○	×	×																							
REC Mode	○	○	○	×																							
23	PB Control		Applying 3.3V DC or more (6.0V max.) to this pin enters EE mode and 1.0V or below PB mode.																								
24	REC Control		Applying 3.0V DC or more (up to VCC) to this pin enters REC mode and 1.0V or below EE mode.																								

- Specifications of any and all SANYO products described or contained herein stipulate the performance, characteristics, and functions of the described products in the independent state, and are not guarantees of the performance, characteristics, and functions of the described products as mounted in the customer's products or equipment. To verify symptoms and states that cannot be evaluated in an independent device, the customer should always evaluate and test devices mounted in the customer's products or equipment.
- SANYO Electric Co., Ltd. strives to supply high-quality high-reliability products. However, any and all semiconductor products fail with some probability. It is possible that these probabilistic failures could give rise to accidents or events that could endanger human lives, that could give rise to smoke or fire, or that could cause damage to other property. When designing equipment, adopt safety measures so that these kinds of accidents or events cannot occur. Such measures include but are not limited to protective circuits and error prevention circuits for safe design, redundant design, and structural design.
- In the event that any or all SANYO products(including technical data, services) described or contained herein are controlled under any of applicable local export control laws and regulations, such products must not be exported without obtaining the export license from the authorities concerned in accordance with the above law.
- No part of this publication may be reproduced or transmitted in any form or by any means, electronic or mechanical, including photocopying and recording, or any information storage or retrieval system, or otherwise, without the prior written permission of SANYO Electric Co., Ltd.
- Any and all information described or contained herein are subject to change without notice due to product/technology improvement, etc. When designing equipment, refer to the "Delivery Specification" for the SANYO product that you intend to use.
- Information (including circuit diagrams and circuit parameters) herein is for example only ; it is not guaranteed for volume production. SANYO believes information herein is accurate and reliable, but no guarantees are made or implied regarding its use or any infringements of intellectual property rights or other rights of third parties.

This catalog provides information as of October, 2000. Specifications and information herein are subject to change without notice.