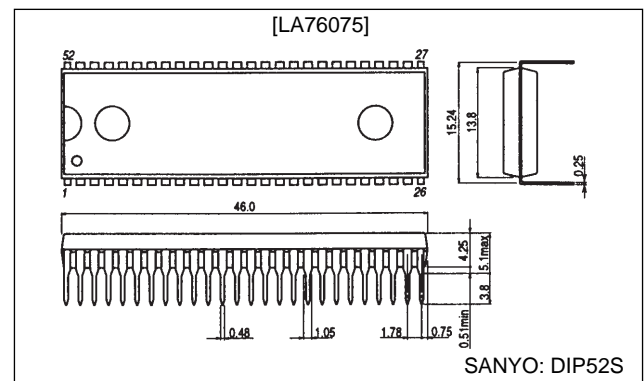

**LA76075****NTSC Color Television Sets****Features**

- I<sup>2</sup>C bus control
- VIF, SIF, Y, C, and deflection blocks on a single chip

**Package Dimensions**

unit: mm

**3128-DIP52S****Specifications****Absolute Maximum Ratings at Ta = 25°C**

Parameter	Symbol	Conditions	Ratings	Unit
Maximum power supply voltage	V4 max		9.6	V
	V26 max		9.6	V
Maximum power supply current	I21 max		25	mA
Allowable power dissipation	Pd max	*Ta ≤ 65°C	1.5	W
Operating temperature	Topr		-10 to +65	°C
Storage temperature	Tstg		-55 to +150	°C

\*Mounted on paper-backed phenol circuit board

**Operating Conditions at Ta = 25°C**

Parameter	Symbol	Conditions	Ratings	Unit
Recommended power supply voltage	V4		7.6	V
	V26		7.6	V
Recommended power supply current	I21		19	mA
Operating power supply voltage range	V4 op		7.3 to 7.9	V
	V26 op		7.3 to 7.9	V
Operating power supply current range	I21 op		17 to 25	mA

■ Any and all SANYO products described or contained herein do not have specifications that can handle applications that require extremely high levels of reliability, such as life-support systems, aircraft's control systems, or other applications whose failure can be reasonably expected to result in serious physical and/or material damage. Consult with your SANYO representative nearest you before using any SANYO products described or contained herein in such applications.

■ SANYO assumes no responsibility for equipment failures that result from using products at values that exceed, even momentarily, rated values (such as maximum ratings, operating condition ranges, or other parameters) listed in products specifications of any and all SANYO products described or contained herein.

**SANYO Electric Co., Ltd. Semiconductor Business Headquarters**

TOKYO OFFICE Tokyo Bldg., 1-10, 1 Chome, Ueno, Taito-ku, TOKYO, 110-8534 JAPAN

## LA76075

### Operating Characteristics at $T_a = 25^\circ\text{C}$ , $V_{CC} = V_4 = V_{26} = 7.6\text{ V}$ , $I_{CC} = I_{21} = 19\text{ mA}$

Parameter	Symbol	Conditions	Ratings			Unit
			min	typ	max	
[Circuit Voltages and Currents]						
Horizontal power supply voltage	HV <sub>CC</sub>		7.2	7.6	8.0	V
IF power supply current	I <sub>4</sub> (IF <sub>CC</sub> )	IF AGC : 5 V	38	46	54	mA
Video, chroma, and vertical power supply current	I <sub>26</sub> (YCV <sub>CC</sub> )	79.5	79.5	93.5	107.5	mA
[VIF Block]						
AFT output voltage with no signal	VAFT <sub>n</sub>	With no signal	2.8	3.8	4.8	V <sub>dc</sub>
Video output voltage with no signal	VO <sub>n</sub>	With no signal	4.7	4.9	5.1	V <sub>dc</sub>
APC pull-in range (U)	f <sub>PU</sub>	After APC and PLL DAC adjustment	1			MHz
APC pull-in range (L)	f <sub>PL</sub>	After APC and PLL DAC adjustment	1			MHz
Maximum RF AGC voltage	V <sub>RFH</sub>	CW = 91 dB $\mu$ , DAC = 0	7.7	8.2	9.0	V <sub>dc</sub>
Minimum RF AGC voltage	VRFL	CW = 91 dB $\mu$ , DAC = 63	0	0.2	0.4	V <sub>dc</sub>
RF AGC delay point (@DAC = 0)	RFAGC0	DAC = 0	96			dB $\mu$
RF AGC delay point (@DAC = 63)	RFAGC63	DAC = 63			86	dB $\mu$
Maximum AFT output voltage	VAFT <sub>H</sub>	CW = 93 dB $\mu$ , Variable frequency	6.2	6.5	7.6	V <sub>dc</sub>
Minimum AFT output voltage	VAFT <sub>L</sub>	CW = 93 dB $\mu$ , Variable frequency	0.5	0.9	1.2	V <sub>dc</sub>
AFT sensitivity	VAFT <sub>S</sub>	CW = 93 dB $\mu$ , Variable frequency	-33	-25	-17	mV/kHz
Video output level	VO	93 dB $\mu$ , 87.5% Video MOD	1.8	2.0	2.2	V <sub>p-p</sub>
Sync tip level	VO <sub>tip</sub>	93 dB $\mu$ , 87.5% Video MOD	2.4	2.6	2.8	V <sub>dc</sub>
Input sensitivity	V <sub>i</sub>	Output at -3 dB		43	46	dB $\mu$
Video/sync ratio	V/S	93 dB $\mu$ , 87.5% Video MOD	2.4	2.5	3.0	
Differential gain	DG	93 dB $\mu$ , 87.5% Video MOD		2	10	%
Differential phase	DP	93 dB $\mu$ , 87.5% Video MOD		2	10	deg
Video signal-to-noise ratio	S/N	CW = 93 dB $\mu$	55	58		dB
920-kHz beat level	I <sub>920</sub>	V3.58 MHz/V920 kHz			-45	dB
[SIF Block]						
FM output level	SOADJ		464	474	484	mV <sub>rms</sub>
FM limiting sensitivity	SLS	Output at -3 dB			55	dB $\mu$
FM frequency characteristic (f <sub>m</sub> = 50 Hz)	SF50	f <sub>m</sub> = 50 Hz	-0.5		+3.0	dB
FM frequency characteristic (f <sub>m</sub> = 100 Hz)	SF100K	f <sub>m</sub> = 100 kHz	-0.5		+3.0	dB
FM total harmonic distortion	STHD	FM = $\pm$ 25 kHz			0.5	%
AM rejection	SAMR	AM = 30%	40			dB
SIF signal-to-noise ratio	SSN		60			dB
[Audio Block]						
Maximum gain	AGMAX	1 kHz	-1.5	1.0	+3.5	dB
Variable range	ARANGE		60	67		dB
Left/right balance	ABAR	1 kHz, 400 mV <sub>rms</sub> , Vol : MAX	-2		+2	dB
f characteristic	AF	20 kHz	-3		+3	dB
Muting	AMUTE	20 kHz	70			dB
Left/right crosstalk	ACT	20 kHz	70			dB
Total harmonic distortion	ATHD	1 kHz, 400 mV <sub>rms</sub> , Vol : MAX			0.5	dB
Signal-to-noise ratio	ASN	DIN.Audio	65	75		dB
[Chroma Block]						
ACC amplitude characteristic 1	ACCM1	Input: +6 dB/0 dB 0 dB = 40IRE	0.8	1.0	1.2	Times
ACC amplitude characteristic 2	ACCM2	Input: -14 dB/0 dB	0.7	0.9	1.0	Times
B-Y/Y amplitude ratio	CLRBY		65	90	110	%
Color control characteristic 1	CLRMN	Color MAX/MOM	1.7	2.0	2.3	Times
Color control characteristic 2	CLRMM	Color MAX/MIN	33	40	50	dB
Color control sensitivity	CLRSE		1	2	4	%/bit
Tint center	TINCEN	TINT NOM	-15		+5	deg

Continued on next page.

## LA76075

Continued from preceding page.

Parameter	Symbol	Conditions	Ratings			Unit
			min	typ	max	
Tint control maximum	TINMAX	TINT MAX	30	45	60	deg
Tint control minimum	TINMIN	TINT MIN	-60	-45	-30	deg
Tint control sensitivity	TINSE		0.7		2.0	deg/bit
Demodulator output R-Y/B-Y ratio	RB	R/B Drive : Adjusted value	0.75	0.85	0.95	
Demodulator output G-Y/B-Y ratio	GB	R/B Drive : Adjusted value	0.28	0.33	0.38	
Demodulator angle B-Y/R-Y	ANGBR		99	104	109	deg
Demodulator angle G-Y/B-Y	ANGGB		230	240	250	deg
Killer operation point	KILL	0 dB = 40 IRE	-36	-26	-20	dB
Chroma VCO free run frequency	CVCOF	Deviation from 3.579545 MHz	-350		+350	Hz
Chroma pull-in range (+)	PULIN+		350			Hz
Chroma pull-in range (-)	PULIN-				-350	Hz
Auto Flesh characteristic 73°	AF073		8	20	30	deg
Auto Flesh characteristic 118°	AF118		-7	0	+7	deg
Auto Flesh characteristic 163°	AF163		-30	-20	-8	deg
Overload characteristic 1	OVL1		3.5		4.9	
Overload characteristic 2	OVL2		6		9.5	
Overload characteristic 3	OVL3		9		15	
fsc output amplitude	Vfsc			300		mVp-p
[Chroma BPF Block]						
Peaker amplitude characteristic 3.08 MHz	CPE308	3.53 MHz standard	-5	-3	-1	dB
Peaker amplitude characteristic 3.88/3.28 MHz	CPE	3.28 MHz standard	-0.5	+1.5	+3.5	dB
Peaker amplitude characteristic 4.08/3.08 MHz	CPE05	3.08 MHz standard	1	4	7	dB
Band pass amplitude characteristic 3.08 MHz	CPE308	3.53 MHz standard	-3.5	-1.5	+0.5	dB
Band pass amplitude characteristic 3.88/3.28 MHz	CBP	3.28 MHz standard	-2	0	+2	dB
Band pass amplitude characteristic 4.08/3.08 MHz	CBP05	3.08 MHz standard	-2.5	0	+2.5	dB
[Video Block]						
Overall video gain at maximum contrast	PIX127		10	12	14	dB
Contrast adjustment characteristic (Normal/max)	PIX63		-7.5	-6.0	-4.5	dB
Contrast adjustment characteristic (Min/max)	PIX0		-15	-12	-9	dB
Video frequency characteristic (f0 = 2)	Y f 02		-12	-9	6	dB
Chroma trapping (f0 = 0)	Ctrap			-25		dB
DC propagation	ClampG		95	100	105	%
Y delay (f0 = 1)	YDLY			430		ns
Maximum black stretching gain	BKSTmax		12	16	20	IRE
Black stretching threshold (40 IRE Δblack)	BKSTH		-2	0	+2	IRE
Sharpness variable range	(normal) Sharp16		4.0	6.0	8.0	dB
	(max) Sharp31		9.0	11.5	14.0	dB
	(min) Sharp0		-6.0	-3.5	-1.0	dB
Coring characteristic	Coring		0.1	0.5	1.2	dB
Horizontal/vertical blanking output level	RGBBLK		1.4	1.7	2.0	V
[On Screen Display (OSD) Block]						
OSD Fast Switch threshold	FS <sub>TH</sub>		0.9	1.2	1.7	V
Red RGB output level	ROSDH		120	165	200	IRE
Green RGB output level	GOSDH		70	120	140	IRE
Blue RGB output level	BOSDH		85	120	155	IRE
Analog OSD Red output level gain match	R <sub>RGB</sub>		1.12	1.4	1.68	Ratio
Linearity	LR <sub>RGB</sub>		45	50	60	%

Continued on next page.

## LA76075

Continued from preceding page.

Parameter	Symbol	Conditions	Ratings			Unit
			min	typ	max	
Analog OSD Green output level gain match	B <sub>RGB</sub>		0.8	1.0	1.2	Ratio
Linearity	LGB <sub>RGB</sub>		45	50	60	%
[RGB Output (Cutoff, Drive) Block]						
Brightness control (normal)	BRT63		2.0	2.50	3.0	V
Hi bright (max)	BRT127		20	25	30	IRE
Low bright (min)	BRT0		-30	-25	-20	IRE
Cutoff control (min)	Vbias0		1.5	2.0	2.5	V
Bias control (max)	Vbias27		3.1	3.6	4.1	V
Resolution	Vbiassns			6.4		mV/Bit
Sub bias control resolution	Bsbiassns		-1	6.4		mV/Bit
Drive adjustment Red/Blue maximum output	RBout127			2.7		Vp-p
Green maximum output	Gout			2.3		Vp-p
Output attenuation	RBout0		7	9	11	dB
Gamma characteristic	* $\gamma$	* = R, G, B	78	85	92	IRE
[Deflection Block]						
Synchronization separation sensitivity	Ssync		3	8	13	IRE
Horizontal free run frequency deviation	$\Delta fH$		15600	15734	15850	Hz
Horizontal pull-in range	fH PULL		$\pm 400$			Hz
Horizontal output pulse width @0	Hduty0	ON time, Hduty : 0	36.1	37.6	39.1	$\mu s$
Horizontal output pulse width @1	Hduty1	ON time, Hduty : 1	34.1	35.6	37.1	$\mu s$
Horizontal output pulse saturation voltage	V Hsat		0	0.2	0.4	V
Horizontal output pulse phase	HPH <sub>CEN</sub>		9.5	10.5	11.5	$\mu s$
Horizontal position adjustment range	HPHrange	5 bits		$\pm 2.4$		$\mu s$
Horizontal position maximum range for adjustment	HPHstep				530.0	ns
Operating voltage for X-ray protection circuit	VXRAY		0.58	0.68	0.78	V
[Vertical screen size adjustment]						
Vertical ramp output width @64	Vsize64	VSIZE : 1000000	1.32	1.62	1.92	Vp-p
Vertical ramp output width @0	Vsize0	VSIZE : 0000000	0.63	0.93	1.23	Vp-p
Vertical ramp output width @127	Vsize127	VSIZE : 1111111	2.00	2.30	2.60	Vp-p
[High-voltage dependent vertical size compensation]						
Vertical size compensation @0	Vsizecomp	VCOMP : 00	0.95	0.97	0.99	ratio
[Vertical screen position adjustment]						
Vertical ramp DC voltage @64	Vdc64	VDC : 1000000	3.39	3.74	4.09	Vdc
Vertical ramp DC voltage @0	Vdc0	VDC : 0000000	2.56	2.91	3.26	Vdc
Vertical ramp DC voltage @127	Vdc127	VDC : 1111111	4.21	4.56	4.91	Vdc
Vertical linearity @16	Vlin16	VLIN : 100000	0.84	0.99	1.14	ratio
Vertical linearity @0	Vlin0	VLIN : 000000	1.25	1.40	1.55	ratio
Vertical linearity @31	Vlin31	VLIN : 111111	0.56	0.71	0.86	ratio
Vertical S-correction @16	VScor16	VS : 10000	0.57	0.72	0.87	ratio
Vertical S-correction @0	VScor0	VS : 00000	0.85	1.00	1.15	ratio
Vertical S-correction @31	VScor31	VS : 11111	0.38	0.53	0.68	ratio
Horizontal size adjustment						
East/West DC voltage @32	EWdc32	EWDC : 100000	3.35	3.80	4.25	Vdc
East/West DC voltage @0	EWdc0	EWDC : 000000	1.40	1.35	2.30	Vdc
East/West DC voltage @63	EWdc63	EWDC : 111111	5.25	5.70	6.15	Vdc
[High-voltage dependent horizontal size compensation]						
Horizontal size compensation @0	Hsizecomp	HCOMP : 000	0.9	1.1	1.3	V

Continued on next page.

## LA76075

Continued from preceding page.

Parameter	Symbol	Conditions	Ratings			Unit
			min	typ	max	
[Pincushion distortion compensation]						
East/West parabola amplitude @32	EWamp32	EWAMP : 100000	1.55	1.90	2.25	Vp-p
East/West parabola amplitude @0	EWamp0	EWAMP : 000000	0.00	0.03	0.35	Vp-p
East/West parabola amplitude @63	EWamp63	EWAMP : 111111	3.45	3.80	4.15	Vp-p
[Keystone distortion compensation]						
East/West parabola tilt @32	EWtilt32	EW TILT : 100000	-0.28	0.12	0.52	V
East/West parabola tilt @0	EWtilt0	EW TILT : 000000	-1.76	-1.36	-0.96	V
East/West parabola tilt @63	EWtilt63	EW TILT : 111111	1.17	1.57	1.92	V
[Corner distortion compensation]						
East/West parabola corner top	EWcorTOP	ORTOP : 1111-0000	0.7	1.0	1.3	V
East/West parabola corner bottom	EWcorBOT	CORBOTTOM : 1111-0000	0.8	1.1	1.4	V

LA76075

LA76075 Bus Control Register Bit Allocation Map

IC Address (WRITE) : 10111010

Control Register Bit Allocations									
Sub Address	MSB		DATA BITS					LSB	
	Bit7	Bit6	Bit5	Bit4	Bit3	Bit2	Bit1	Bit0	
00000000	· (0)	· (0)	T_Enable 1	Audil Mute 0	Video Mute 0	H duty 1	Sync Kill 0	AFC Gain 0	
00001	· (0)	· (0)	· (0)	Horizontal Phase					0
00010	IF AGC DEF 0	AFT DEF 0	RF AGC Delay						0
00011	Video Level			FM Level					0
00100	BNI Enable 0	IF VCO Free Run							0
00101	· (0)	· (0)	IF APC Offset Adjust						0
00110	· (0)	Vol Flr DEF 0	Volume control						0
00111	· (0)	· (0)	East-West DC						0
01000	· (0)	VDC							0
01001	V kill 0	V Size							0
01010	· (0)	Count Down Mode		Vetical Linearity					0
01011	Horizonal Size Comp			Vertical S-correction					0
01100	Vrt Size Comp		East-West Amplitude						0
01101	· (0)	Red Bias							0
01110	· (0)	Green Bias							0
01111	· (0)	Blue Bias							0

(Bits are transmitted in this order.)

LA76075

LA76075 Bus Control Register Bit Allocation Map

Control Register Bit Allocations (continued)								
Sub Address	MSB							
	Bit7	Bit6	Bit5	Bit4	Bit3	Bit2	Bit1	Bit0
00010000	(0)	Red Drive						
		1	1	1	1	1	1	1
10001	(0)	.	.	.	.	.	.	.
		(0)	(0)	(0)	(0)	(0)	(0)	(0)
10010	(0)	Blue Drive						
		1	1	1	1	1	1	1
10011	(0)	Sub Brightness						
		1	0	1	0	1	0	1
10100	(0)	Brightness Control						
		1		0	0	0	0	00
10101	(0)	Pix Control						
		1	0	0	0	0	0	0
10110	Auto Flesh 0	Overload	Coring	Sharpness control				
		0	0	0	0	0	0	0
10111	Tint Test 0	Tint Control						
		1	0	0	0	0	0	0
11000	Color Test 0	Color Control						
		1	0	0	0	0	0	0
11001	F0 Select		BrT ABL DEF	Mid Stp DEF	Emg ABL DEF	Bright ABL Threshold		
	0	1	0	0	0	1	1	1
11010	Chr.BPF	Chr.Bypass	Pix Test	Drive Test	Gamma Def	Blk Str DEF	Blankig DEF	Color Diff
	0	0	0	1	0	0	0	0
11011	(0)	(0)	East-West Tilt					
			1	0	0	0	0	0
11100	East-West Bottom Corner				East-West Top Corner			
	0	0	0	0	0	0	0	0
11101	(0)	(0)	(0)	(0)	(0)	(0)	(0)	(0)
11110	(0)	(0)	(0)	(0)	(0)	Vertical Test		
						0	0	0
11111	(0)	(0)	(0)	(0)	(0)	(0)	(0)	(0)

(Bits are transmitted in this order.)

LA76075 Bus Status Register Bit Allocation Map

IC Address (READ) : 10111011

Status Register Bit Allocations							
MSB		DATA BITS					LSB
Bit7	Bit6	Bit5	Bit4	Bit3	Bit2	Bit1	Bit0
.	Status Field		.	.	.	AFT Field	
.	.	.	.	.	.	.	.

## LA76075

## LA76075 Bus Data

Unit : Decimal

Register	TR(Sub Address)	BIT	INITIAL	MAX	MIN
T Enable	0	1	1	1	0
Audio Mute	0	1	0	1	0
Video Mute	0	1	0	1	0
Horizontal Duty	0	1	1	1	0
Sync Kill	0	1	0	1	0
AFC Gain	0	1	0	1	0
Horizontal Phase	1	5	16	31	0
IF AGC Defeat	2	1	0	1	0
AFT Defeat	2	1	0	1	0
RF AGC Delay	2	6	32	63	0
Video Level	3	3	4	7	0
FM Level	3	5	16	31	0
BNI Defeat	4	1	0	1	0
IF VCO Free Run	4	7	64	127	0
IF APC Offset Adjust	5	6	32	63	0
Volume Filter Defeat	6	1	0	1	0
Volume Control	6	6	32	63	0
East/West DC	7	6	32	63	0
Vertical DC	8	7	64	127	0
Vertical Kill	9	1	0	1	0
Vertical Size	9	7	64	127	0
Count Down Mode	10	2	0	3	0
Vertical Linearity	10	5	16	31	0
Horizontal Size Compensation	11	3	0	7	0
Vertical S-Correction	11	5	0	31	0
Vertical Size Compensation	12	2	2	3	0
East/West Amplitude	12	6	32	63	0
Red Bias	13	7	0	127	0
Green Bias	14	7	0	127	0
Blue Bias	15	7	0	127	0
Red Drive	16	7	127	127	0
Blue Drive	18	7	127	127	0
Sub Brightness	19	7	85	127	0
Brightness Control	20	7	64	127	0
Pix Control	21	7	64	127	0
AutoFlesh	22	1	0	1	0
Overload	22	1	0	1	0
Coring Enable	22	1	0	1	0
Sharpness Control	22	5	0	31	0
Tint DAC Test	23	1	0	1	0
Tint Control	23	7	64	127	0
Color DAC Test	24	1	0	1	0
Color Control	24	7	64	127	0
F0 Select	25	2	1	3	0
Bright ABL Defeat	25	1	0	1	0
Bright Mid Stop Defeat	25	1	0	1	0
Emergency ABL Defeat	25	1	0	1	0
Bright ABL Threshold	25	3	7	7	0
Chroma BPF	26	1	0	1	0
Chroma Bypass	26	1	0	1	0
Pix DAC Test	26	1	0	1	0
Drive DAC Test	26	1	0	1	0
Gamma Defeat	26	1	0	1	0
Black Stretch Defeat	26	1	0	1	0
Blanking Defeat	26	1	0	1	0
Color Difference Mode Enable	26	1	0	1	0
East/West Tilt	27	6	32	63	0
East/West Bottom Corner	28	4	0	15	0
East/West Top Corner	28	4	0	15	0
Vertical Test	30	3	0	7	0



## LA76075 Bus Initial Test Conditions

Initial Test Conditions	
Register	
T Enable	1HEX
Audio Mute	0HEX
Video Mute	0HEX
Horizontal Duty	1HEX
Sync Kill	0HEX
AFC Gain	0HEX
Horizontal Phase	10HEX
IF AGC Defeat	0HEX
AFT Defeat	0HEX
RF AGC Delay	20HEX

Initial Test Conditions(continued)	
Register	
Video Level	4HEX
FM Level	10HEX
BNI Enable	0HEX
IF VCO Free Run	40HEX
IF APC Offset Adjust	20HEX
Volume Filter Defeat	0HEX
Volume Control	20HEX
East/West DC	20HEX
Vertical DC	40HEX
Vertical Kill	0HEX
Vertical Size	40HEX
Count Down Mode	0HEX
Vertical Linearity	10HEX
Horizontal Size Compensation	0HEX
Vertical S-correction	00HEX
Vertical Size Compensation	2HEX
East/West Amplitude	20HEX
Red Bias	00HEX
Green Bias	00HEX
Blue Bias	00HEX
Red Drive	7FHEX
Blue Drive	7FHEX
Sub Brightness	55HEX
Brightness Control	40HEX
Pix Control	40HEX
Auto Flesh	0HEX
Overload	0HEX
Corning Enable	0HEX
Sharpness Control	00HEX
Tint DAC Test	0HEX
Tint Control	40HEX
Color DAC Test	0HEX
Color Control	40HEX
F0 Select	1HEX
Bright ABL Defeat	0HEX
Bright Mid Stop Defeat	0HEX
Emergency ABL Defeat	0HEX
Bright ABL Threshold	7HEX
Chroma BPF	0HEX
Chroma Bypass	0HEX
Pix DAC Test	0HEX
Drive DAC Test	0HEX
Gamma Defeat	1HEX
Black Stretch Defeat	1HEX
Blinking Defeat	0HEX
Color Dfference Mode Enable	0HEX
East/West Tilt	20HEX
East/West Bottom Corner	0HEX
East/West Top Corner	0HEX
Vertical Test	0HEX

## LA76075 Bus : Control Register Descriptions

Control Register Descriptions		
Register Name	Bits	General Description
T_Enable	1	Enable test mode
Audio Mute	1	Disable audio outputs
Video Mute	1	Disable video outputs
Horizontal Duty	1	Select horizontal drive duty cycle
Sync Kill	1	Force free-run mode
AFG Gain	1	Select horizontal drive duty gain
Horizontal Phase	5	Phase alignment for sync signal and flyback pulse
IF AGC Defeat	1	Disable IF and RF AGC
AFT Defeat	1	Disable AFT output
RF AGC Delay	6	Align RF AGC threshold
Video Level	3	Align IF video level
FM level	5	Align WBA output level
BNI Enable	1	Enable black noise inverter
IF VCO Free RUN	7	Align IF VCO frequency
IF APC Offset Adjust	6	Align AFT crossover
Volume Filter Defeat	1	Disable volume DAC filter
Volume Control	6	Customer volume control
East/West DC	6	Align E/W Waveform DC
Vertical DC	7	Align vertical DC bias
Vertical Kill	1	Disable vertical output
Vertical Size	7	Align vertical amplitude
Count Down Mode	2	Select vertical countdown mode
Vertical Linearity	5	Align vertical linearity
Horizontal Size Compensation	3	Align horizontal size compensation
Vertical S-correction	5	Align vertical S-correction
Vertical Size Compensation	2	Align vertical size compensation
East/West Amplitude	6	Align E/W amplitude
Red Bias	7	Align Red OUT DC level
Green Bias	7	Align Green OUT DC level
Blue Bias	7	Align Blue OUT DC level
Red Drive	7	Align Red OUT AC level
Blue Drive	7	Align Blue OUT AC level
Sub Brightness	7	Align common RGB DC level
Brightness Control	7	Customer brightness control
Pix Control	7	Customer contrast control
AutoFlesh	1	Enable autoflesh function
Overload	1	Enable chroma overload
Coring Enable	1	Enable luminance coring
Sharpness Control	5	Customer sharpness control
Tint DAC Test	1	Enable tint DAC test mode
Tint Control	7	Customer tint control
Color DAC Test	1	Enable color DAC test mode
Color control	7	Customer color control
F0 Select	2	Select luma filter mode
Bright ABL Defeat	1	Disable brightness ABL
Bright Mid Stop Defeat	1	Disable brightness mid stop
Emergency ABL Defeat	1	Disable emergency brightness ABL
Bright ABL Threshold	3	Align brightness ABL threshold
Chroma BPF	1	Select chroma filter mode
Chroma Bypass	1	Select chroma filter bypass

LA76075

LA76075 Bus Control Register Descriptions

Control Register Descriptions		
Register Name	Bits	General Description
Pix DAC Test	1	Enable pix DAC test mode
Drive DAC Test	1	Enable drive DAC test mode
Gamma Defeat	1	Disable gamma correction
Black Stretch Defeat	1	Disable black stretch
Blanking Defeat	1	Disable RGB output blanking
Color Difference Mode Enable	1	Enable color difference mode
East/West Tilt	6	Align E/W tilt
East/West Bottom Corner	4	Align bottom corner correction
East/West Top Corner	4	Align top corner correction
Vertical Test	3	Select vertical DAC test modes

LA76075 Bus Control Register Truth Table

Control Register Truth Table				
Register Name	0HEX	1HEX	2HEX	3HEX
T Enable	Test Enable	Test Disable		
Audio Mute	Active	Mute		
Video Mute	Active	Mute		
Horizontal Duty				
Sync Kill	Sync active	Sync killed		
AFC Gain	Slow	Fast		
IF AGC Defeat	AGC active	AGC defeat		
AFT Defeat	AFT active	AFT defeat		
BNI Enable	BNI active	BNI defeat		
Volume Filter Defeat	Ftr active	Ftr defeat		
Count Down Mode	Standard	Non-Stand	50Hz	48Hz
Vertical Kill	Vrt active	Vrt killed		
Auto Flesh Enable	AF Off	AF On		
Overload Enable	Ovld Off	Ovld On		
Coring Enable	Core Off	Core On		
Tint DAC Test	Normal	Test Mode		
Color DAC Test	Normal	Test Mode		
F0 Select	3.58trap	4.60trap	8.00APF	na
Bright ABL Defeat	BrT ABL On	BrT ABL Off		
Bright Mid Stop Defeat	Mid Stp On	Mid Stp Off		
Emergency ABL Defeat	Emg On	Emg Off		
Chroma BPF	Symm	Peak		
Chroma Bypass	Filter	Bypass		
Pix DAC Test	Normal	Test Mode		
Drive DAC Test	Normal	Test Mode		
Gamma Defeat	Gamma	Linear		
Black Stretch Defeat	Blk Str On	Blk Str Off		
Blanking Defeat	Blanking	No Blank		
Color Diff Mode Enable	RGB Mode	C Diff Mode		
Vertical Test	0HEX	1HEX	2HEX	3HEX
	Normal	Vrt S Corr	Vrt Lin	Vrt Size
	4HEX	5HEX	6HEX	7HEX
	E/W Amp	E/W Tilt	E/W Corner	E/W DC

LA76075 Bus Status Byte Truth Table

Status Byte Truth Table				
Register	0HEX	1HEX	2HEX	3HEX
Status Field	Don't Care	Horiz Unlocked	Horiz Locked	Don't Care
AFT Field	IF Freq is high	IF Freq is range	na	IF Freq is low

## LA76075





### Measurement Conditions at $T_a = 25^\circ\text{C}$ , $V_{CC} = V_4 = V_{26} = 7.6\text{ V}$ , $I_{CC} = I_{21} = 19\text{ mA}$

Item	Symbol	Measurement Point	Input Signal	Measurement Procedure	Bus Condition
[Circuit Voltage and Current]					
Horizontal power supply voltage	$HV_{CC}$	②1		Feed a 19-mA current to pin 21 and measure the voltage at that pin.	Initial
IF power supply current	$I_4$ ( $IF_{I_{CC}}$ )	④	No signal	Apply 7.6 V to pin 4 and measure the DC current (mA) flowing in. (Apply 5 V to the IF AGC pin.)	Initial
Video, chroma, and vertical power supply voltage	$I_{26}$ ( $YCV_{I_{CC}}$ )	②6		Apply 7.6 V to pin 26 and measure the DC current (mA) flowing in.	Initial

## LA76075

### VIF Block Input Signals and Measurement Conditions

1. Input the input signals to the VIF IN pin noted on the measurement circuit diagrams.
2. The input signal levels are the VIF IN levels noted on the measurement circuit diagrams.
3. The following table describes the input signals.

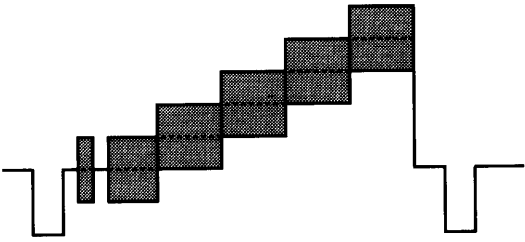
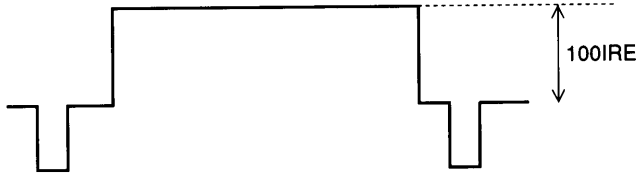
Input Signal	Waveform	Conditions
SG1	 CW	45.75 MHz
SG2	 CW	42.17 MHz
SG3	 CW	41.25 MHz
SG4	 CW	Variable frequency
SG5		45.75 MHz 87.5% Video Mod. Ten-step wave using 3.58-MHz subcarrier
SG6	 100IRE	45.75 MHz 87.5% Video Mod. Flat field signal

4. Before starting the measurements, adjust the digital-to-analog converters in the following order.

Item	Measurement Point	Input Signal	Target Value
APC DAC	⑬	No signal, IF.AGC.DEF = 1	Adjust to bring the DC voltage at pin 13 as close as possible to 3.8 V.
PLL DAC	⑬	SG1, 93 dBμ	Adjust to bring the DC voltage at pin 13 as close as possible to 3.8 V.
Video Level DAC	④⑤	SG6, 93 dBμ	Adjust to bring the output level at pin 45 as close as possible to 2.0 Vp-p.

## LA76075

Item	Symbol	Measurement Point	Input Signal	Measurement Procedure	Bus Condition
[VIF Block]					
AFT output voltage with no signal	$V_{AFTn}$	13	No signal	Set IF.AGC.DEF to "1" and measure the DC voltage at pin 13.	See Section 4 for the adjustment value.
Video output voltage with no signal	$V_{On}$	45	No signal	Set IF.AGC.DEF to "1" and measure the DC voltage at pin 45.	See Section 4 for the adjustment value.
APC pull-in range (U), (L)	fPU, fPL	45	SG4 93 dB $\mu$	Connect an oscilloscope to pin 45, apply a frequency higher than 45.75 MHz to SG4, and unlock the phase-locked loop to produce beats. Gradually lower the frequency until the PLL locks and calculate the difference with 45.75 MHz. Repeat the procedure from the opposite direction, lowering the frequency until the PLL unlocks, raising it, and then calculating the difference between the frequency at which the PLL locks and 45.75 MHz.	See Section 4 for the adjustment value.
Maximum RF AGC voltage	$V_{RFH}$	6	SG1 91 dB $\mu$	Set the RF AGC DAC to 0 and measure the DC voltage at pin 6.	See Section 4 for the adjustment value.
Minimum RF AGC voltage	$V_{RFL}$	6	SG1 91 dB $\mu$	Set the RF AGC DAC to 63 and measure the DC voltage at pin 6.	See Section 4 for the adjustment value.
RF AGC Delay Pt (@DAC = 0)	RFAGC0	6	SG1	Set the RF AGC DAC to 0 and note the point at which the DC voltage at pin 6 is closest to 3.8 V.	See Section 4 for the adjustment value.
RF AGC Delay Pt (@DAC = 63)	RFAGC63	6	SG1	Set the RF AGC DAC to 63 and note the point at which the DC voltage at pin 6 is closest to 3.8 V.	See Section 4 for the adjustment value.
Maximum AFT output voltage	$V_{AFTH}$	13	SG4 93 dB $\mu$	Apply a 44.75MHz signal to SG4 0 and measure the DC voltage at pin 13.	See Section 4 for the adjustment value.
Minimum AFT output voltage	$V_{AFTL}$	13	SG4 93 dB $\mu$	Apply a 46.75MHz signal to SG4 0 and measure the DC voltage at pin 13.	See Section 4 for the adjustment value.
AFT sensitivity	$V_{AFTS}$	13	SG4 93 dB $\mu$	Vary the SG4 frequency and determine the frequency differential $\Delta f$ required to change the DC voltage at pin 13 from 2.5 V to 5.0 V. $V_{AFTS} = 2500/\Delta f$ [mV/kHz]	See Section 4 for the adjustment value.
Video output level	VO	45	SG6 93 dB $\mu$	Connect an oscilloscope to pin 45 and measure the peak-to-peak amplitude.	See Section 4 for the adjustment value.
Sync tip level	$V_{Otip}$	45	SG1 93 dB $\mu$	Measure the DC voltage at pin 45.	See Section 4 for the adjustment value.
Input sensitivity	$V_i$	45	SG6	Connect an oscilloscope to pin 45 and measure the peak-to-peak amplitude. Gradually lower the input level and note the level at which the video output amplitude (VO) is -3 dB.	See Section 4 for the adjustment value.
Video/sync ratio	V/S	45	SG6 93 dB $\mu$	Connect an oscilloscope to pin 45, measure the peak-to-peak amplitudes of the SYNC waveform (Vs) and the brightness signal (Vy), and determine the ratio $V_y/V_s$ .	See Section 4 for the adjustment value.
Differential gain	DG	45	SG5 93 dB $\mu$	Measure the pin 45 output with a vectorscope.	See Section 4 for the adjustment value.
Differential phase	DP	45	SG5 93 dB $\mu$	Measure the pin 45 output with a vectorscope.	See Section 4 for the adjustment value.
Video signal-to-noise ratio	S/N	45	SG1 93 dB $\mu$	Pass the pin 45 noise output through a band pass filter covering 10 kHz to 4 MHz, measure the level ( $V_{sn}$ ) with an RMS voltmeter, and substitute in the following formula. $S/N = 20 \log (1.43/V_{sn})$	See Section 4 for the adjustment value.
920-kHz beat level	I920	45	SG1 SG2 SG3	Apply a 93dB $\mu$ signal to SG1 and measure the DC voltage ( $V_{12}$ ) at pin 12. Mix the following signals and apply them to VIF IN: SG1 = 87 dB $\mu$ , SG2 = 82 dB $\mu$ , and SG3 = 62 dB $\mu$ . Apply the $V_{12}$ level from an external power supply to pin 12. Measure the difference between the 3.58MHz and 920kHz components from pin 45 with a spectrum analyzer.	See Section 4 for the adjustment value.

## LA76075

### SIF (FM) Block Input Signals and Measurement Conditions

Unless otherwise specified for the items, apply the following conditions.

1. Use the following bus control condition: IF.AGC.DEF = "1."
2. SW:IF1 = "ON"
3. Apply the input signal to pin 49. Use a carrier frequency of 4.5 MHz.

Item	Symbol	Measurement Point	Input Signal	Measurement Procedure	Bus Condition
FM output level	SOADJ	7	90 dB $\mu$ , fm = 400 Hz, FM = $\pm$ 25 kHz	Adjust the DAC FM.LEVEL to bring the 400 Hz component of the pin 7 FM wave detection output as close as possible to 474 mVrms. Measure SV1, the output level (mVrms).	
FM limiting sensitivity	SLS	7	fm = 400 Hz, FM = $\pm$ 25 kHz	Determine the input level (dB $\mu$ ) at which the 400 Hz component of the pin 7 FM wave detection output is -3 dB relative to SV1.	FM.LEVEL = adjusted value
FM f characteristic (fm = 50 Hz)	SF50	7	90 dB $\mu$ , fm = 50 Hz, FM = $\pm$ 25 kHz	Set SW:IF1 to "OFF." Measure SV2, the output level (mVrms) for the pin 7 FM wave detection output, and substitute in the following formula. SF50 = 20 $\times$ LOG(SV1/SV2) [dB]	FM.LEVEL = adjusted value
FM f characteristic (fm = 100 Hz)	SF100K	7	90 dB $\mu$ , fm = 100 Hz, FM = $\pm$ 25 kHz	Set SW:IF1 to "OFF." Measure SV3, the output level (mVrms) for the pin 7 FM wave detection output, and substitute in the following formula. SF100K = 20 $\times$ LOG(SV1/SV2) [dB]	FM.LEVEL = adjusted value
FM total harmonic distortion	STHD	7	90 dB $\mu$ , fm = 400 Hz, FM = $\pm$ 25 kHz	Determine the total harmonic distortion for the 400-Hz component of the pin 7 FM wave detection output.	FM.LEVEL = adjusted value
AM rejection	SAMR	7	90 dB $\mu$ , fm = 400 Hz, AM = 30%	Measure SV4, the 400 Hz component (mVrms) of the pin 7 FM wave detection output, and substitute in the following formula. SAMR = 20 $\times$ LOG(SV1/SV4) [dB]	FM.LEVEL = adjusted value
SIF signal-to-noise ratio	SSN	7	90 dB $\mu$ , CW	Measure SV5, the noise level (mVrms) at pin 7, and substitute in the following formula. SSN = 20 $\times$ LOG(SV1/SV5) [dB]	FM.LEVEL = adjusted value

**Audio Block Input Signals and Measurement Conditions**

1. Input the left channel signal to pin 1, and input 51 IN and right channel signals to pin 47 and measured at pin 47.
2. Use the following bus control condition: VOL.FIL.DEF = "0."

Item	Symbol	Measurement Point	Input Signal	Measurement Procedure	Bus Condition
Maximum gain	AGMAX	47, 51	1 KHz, CW 400 mVrms	Measure V1, the 1 kHz component (mVrms) at the output pin, and substitute in the following formula. $AGMAX = 20 \times \text{LOG}(V1/400)$ [dB]	VOLUME : 111111 AUDIO.MUTE : 0
Variable range	ARANGE	47, 51	1 KHz, CW 400 mVrms	Measure V2, the 1 kHz component (mVrms) at the output pin, and substitute in the following formula. $AGMAX = 20 \times \text{LOG}(V1/V2)$ [dB]	VOLUME : 000000 AUDIO.MUTE : 0
Left/right balance	ABAR	47, 51	1 KHz, CW 400 mVrms	Compute the ratio of the left channel output to the right channel output.	VOLUME : 111111 AUDIO.MUTE : 0
f characteristic	AF	47, 51	20 KHz, CW 400 mVrms	Measure V3, the 20 kHz component (mV{rms}) at the output pin, and substitute in the following formula. $AF = 20 \times \text{LOG}(V3/V1)$ [dB]	VOLUME : 111111 AUDIO.MUTE : 0
Muting	AMUTE	47, 51	20 KHz, CW 400 mVrms	Set AUDIO.MUTE to "1," measure V4, the 20 kHz component at the output pin, and substitute in the following formula. $AMUTE = 20 \times \text{LOG}(V3/V4)$ [dB]	VOLUME : 111111 AUDIO.MUTE : 1
Left/right crosstalk	ACT	47, 51	20 KHz, CW 400 mVrms	Input the left signal only and compute the ratio of the left channel output to the right channel output.	VOLUME : 111111 AUDIO.MUTE : 0
Total harmonic distortion	ATHD	47, 51	1 KHz, CW 400 mVrms	Determine the total harmonic distortion in the 1 kHz component at the output pin.	VOLUME : 111111 AUDIO.MUTE : 0
S/N	ASN	47, 51	No signal	Measure SV5, the noise level (mVrms) at the output pin, and substitute in the following formula. $ASN = 20 \times \text{LOG}(V1/V5)$ [dB]	VOLUME : 111111 AUDIO.MUTE : 0



### Chroma Block Input Signals and Measurement Conditions

Unless otherwise specified for the items, apply the following conditions.

1. VIF and SIF blocks: No signals
2. Deflection block: Supply a composite horizontal and vertical synchronization signal and make sure that the deflection block is locked onto that signal. (For details, see the section "Input Signals and Measurement Conditions.")
3. Bus control conditions: Adjust the digital-to-analog converter to produce the best color (RGB) equality in the Y signal levels from pins 28 (RED OUT), 29 (GRN OUT), and 30 (BLU OUT). Set Gamma Def to "1" (defeat). Unless otherwise specified, use the initial values for all other settings.
4. Adjust the impedance (Z) of the crystal resonator, series capacitor, and resistor to the following value.  
 $Z = 0\text{deg} @ 3.579545\text{MHz} \pm 10\text{Hz} -40 \pm 1\text{deg} @ 3.579345\text{MHz}$
5. Y input: Unless otherwise specified, use the 0 IRE signal. (A synchronization signal is also necessary.)
6. C input: Connect this to pin 40 (CIN).
7. Calculate the demodulation angles with the following formulas.

$$\text{R-Y axis} = \tan^{-1} (B(0)/B(270)) + 270^\circ$$

$$\text{B-Y axis} = \tan^{-1} (R(180)/R(90)) + 90^\circ$$

$$\text{G-Y axis} = \tan^{-1} (G(270)/G(180)) + 180^\circ$$

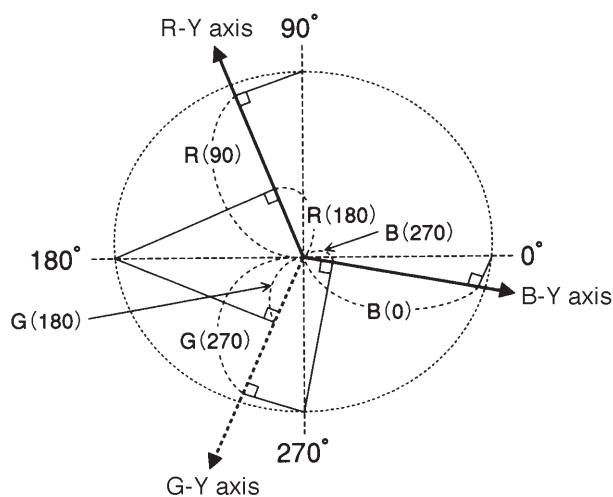

A10005

8. Calculate the AF angle with the following formula, where BR is the B-Y/R-Y demodulation output ratio and  $\theta$  is ANGBR, the B-Y/R-Y demodulation angle.

$$\text{AFXXX} = \tan^{-1} \left( \frac{\text{R-Y/B-Y} \times \text{BR} \cos \theta}{\sin \theta} \right)$$

9. Chroma input signals

C-1

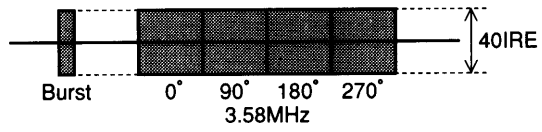

A10006

77 IRE (L-77)



A10007

C-2

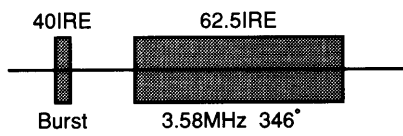

A10008

C-3

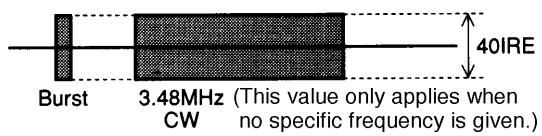

A10009

C-4

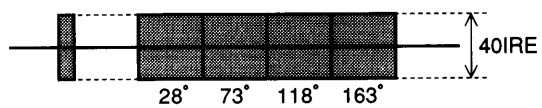

A10010

C-5

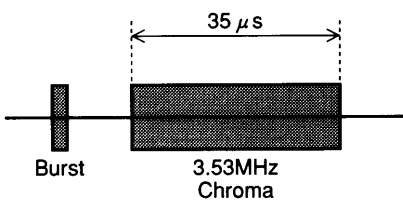

A10011

## LA76075

Item	Symbol	Measurement Point	Input Signal	Measurement Procedure	Bus Condition
[Chroma Block]					
ACC amplitude characteristic 1	ACCM1	Bout 30	C-1 0 dB +6 dB	Measure the outputs for chroma inputs of 0 dB and +6 dB and substitute in the following formula. $ACCM1 = 20 \log (+6 \text{ dBdata}/0 \text{ dBdata})$	
ACC amplitude characteristic 2	ACCM2	Bout 30	C-1 -14 dB	Measure the outputs for chroma inputs of 0 dB and -14 dB and substitute in the following formula. $ACCM1 = 20 \log (-14 \text{ dBdata}/0 \text{ dBdata})$	
B-Y/Y amplitude ratio	CLRBY	30	YIN : L77 C-1 : No signal	Measure V1, the Y output level.	
			C-2	Next supply the CIN signal (with only the synchronization signal for YIN), measure V2, the output level, and substitute in the following formula. $CLRBY = 100 \times (V2/V1) + 15\%$	
Color control characteristic 1	CLRMN	30	C-3	Measure V1, the output amplitude (Vp-p) for the maximum color control setting, and V2, the output amplitude (Vp-p) for the medium one, and substitute in the following formula. $CLRMN = V1/V2$	Color.1111111 (MAX) Color.1000000 (NOM)
Color control characteristic 2	CLRMM	30	C-3	Measure V3, the output amplitude (Vp-p) for minimum color control setting, and substitute in the following formula. $CLRMN = 20 \log (V1-V3)$	Color.0000000 (MIN)
Color control sensitivity	CLRSE	30	C-3	Measure V4, the output amplitude (Vp-p) for a color control setting of 90, and V5, the output amplitude (Vp-p) for one of 38, and substitute in the following formula. $CLRSM = 100 \times (V4-V5) / (V2 \times 52)$	Color.1011010 Color.0100110
Tint center	TINCEN	30	C-1	Measure the output waveform and calculate the B-Y angle.	TINT : 1000000
Tint control maximum	TINMAX	30	C-1	Measure the output waveform, calculate the B-Y angle, and substitute in the following formula. $TINMAX = B-Y \text{ angle} - TINCEN$	TINT : 1111111
Tint control minimum	TINMIN	30	C-1	Measure the output waveform, calculate the B-Y angle, and substitute in the following formula. $TINMIN = B-Y \text{ angle} - TINCEN$	TINT : 0000000
Tint control sensitivity	TINSE	30	C-1	Measure A1, the angle for a tint control setting of 85, and A2, the angle for one of 42, and substitute in the following formula. $TINSE = (A1-A2)/43$	TINT : 1010101 TINT : 0101010
Demodulator output R-Y/B-Y ratio	RB	29 28 30	YIN : L77 C-1 : No signal YIN : 0RE C-3	Supply the L77 signal to the YIN pin and adjust the red and blue drive digital-to-analog converters until the Y output levels at pins 28 (RED OUT) and 30 (BLU OUT) are closest to that at pin 29 (GRN OUT). 1. After the above adjustment, supply 0 RE to the YIN pin and C-3 to the CIN pin, measure Vb, the BOUT output amplitude (Vp-p), and Vr, the ROUT output amplitude (Vp-p), and substitute in the following formula. $RB = Vr/Vb$	Color : 1000000 B Drive R Drive Adjusted red and blue drive values.
Demodulator output G-Y/B-Y ratio	GB	29	C-3	Measure Vg, the GOUT output amplitude (Vp-p), and substitute in the following formula. $GB = Vg/Vb$ Use the adjusted red and blue drive values from the RB determination above.	Color : 1000000 B Drive Use adjusted red and blue drive values from the RB determination above.

Continued on next page.

## LA76075

Continued from preceding page.

Item	Symbol	Measurement Point	Input Signal	Measurement Procedure	Bus Condition
Demodulator angle B-Y/ R-Y	ANGBR	30 28	C-1	Measure the BOUT and ROUT output levels, calculate the B-Y and R-Y angles, and substitute in the following formula. ANGBR = R-Y angle - B-Y angle	
Demodulator angle G-Y/ B-Y	ANGBG	29	C-1	Measure the GOUT output level, calculate the B-Y and R-Y angles, and substitute in the following formula. ANGBG = G-Y angle - B-Y angle	
Killer operation point	KILL	30	C-3	Gradually lower the input signal level and measure the input level at which the output level falls below 150 mVp-p	
Chroma VCO free run frequency	CVCOF	42	CIN No signal	Measure the oscillation frequency f and substitute in the following formula. CVCOF = f - 357945 (Hz)	
Chroma pull-in range (+)	PULIN <sup>+</sup>	30	C-1	Gradually lower the input signal subcarrier frequency from 3.57545 MHz + 1000 Hz and measure the frequency at which the output waveform locks.	
Chroma pull-in range (-)	PULIN <sup>-</sup>	30	C-1	Gradually raise the input signal subcarrier frequency from 3.57545 MHz - 1000 Hz and measure the frequency at which the output waveform locks.	
Auto Flesh characteristic 73°	AF073	30 28	C-4	Set AutoFlesh to "0," measure the levels at the 73° portions of the BOUT and ROUT output waveforms, and calculate the angle AF073A. Set AutoFlesh to "1," repeat the procedure to determine AF073B, and substitute in the following formula. AF073 = AF073B - AF073A	AutoFlesh : 0 AutoFlesh : 1
Auto Flesh characteristic 118°	AF118	30 28	C-4	Set AutoFlesh to "0," measure the levels at the 118° portions of the BOUT and ROUT output waveforms, and calculate the angle AF118A. Set AutoFlesh to "1," repeat the procedure to determine AF118B, and substitute in the following formula. AF118 = AF118B - AF118A	AutoFlesh : 0 AutoFlesh : 1
Auto Flesh characteristic 163°	AF163	30 28	C-4	Set AutoFlesh to "0," measure the levels at the 163° portions of the BOUT and ROUT output waveforms, and calculate the angle AF163A. Set AutoFlesh to "1," repeat the procedure to determine AF163B, and substitute in the following formula. AF163 = AF163B - AF163A	AutoFlesh : 0 AutoFlesh : 1
Overload characteristic 1	OVL1	28	C-5	Measure V1, the output amplitude (Vp-p) for an input signal burst level of 40 IRE and a chroma level of 8 IRE, and V2, the same for a burst level of 40 IRE and a chroma level of 40 IRE, and substitute in the following formula. OVL1 = V2/V1	OverLoad : 1
Overload characteristic 2	OVL2	28	C-5	Measure V3, the output amplitude (Vp-p) for an input signal burst level of 40 IRE and a chroma level of 80 IRE, and substitute in the following formula. OVL2 = V3/V1	OverLoad : 1
Overload characteristic 3	OVL3	28	C-5	Measure V4, the output amplitude (Vp-p) for an input signal burst level of 20 IRE and a chroma level of 80 IRE, and substitute in the following formula. OVL3 = V4/V1	OverLoad : 1
fsc output amplitude (Vp-p)	Vfsc	42	C-1	Measure the output amplitude (Vp-p) of the 3.58-MHz CW output at pin 42 (FSC OUT).	

Continued on next page.

## LA76075

Continued from preceding page.

Item	Symbol	Measurement Point	Input Signal	Measurement Procedure	Bus Condition
[Chroma BPF Block]					
Peaker amplitude characteristic 3.08 MHz	CPE308	30	C-3	Measure V0, the output amplitude (Vp-p). Measure V1, the output amplitude (Vp-p) for an input chroma (CW) frequency of 3.08 MHz, and substitute in the following formula. $CPE308 = 20\log(V1/V0)$	CHR.BPF : 1
Peaker amplitude characteristic 3.88 MHz / 3.28 MHz	CPE	30	C-3	Measure V2, the output amplitude (Vp-p) for an input chroma (CW) frequency of 3.28 MHz, and V3, the same for 3.88 MHz, and substitute in the following formula. $CPE = 20\log(V3/V2)$	CHR.BPF : 1
Peaker amplitude characteristic 4.08 MHz / 3.08 MHz	CPE05	30	C-3	Measure V4, the output amplitude (Vp-p) for an input chroma (CW) frequency of 4.08 MHz, and substitute in the following formula. $CPE05 = 20\log(V4/V1)$	CHR.BPF : 1
Band pass amplitude characteristic 3.08 MHz	CBE308	30	C-3	Measure V5, the output amplitude (Vp-p). Measure V6, the output amplitude (Vp-p) for an input chroma (CW) frequency of 3.08 MHz, and substitute in the following formula. $CBE308 = 20\log(V6/V5)$	CHR.BPF : 0
Band pass amplitude characteristic 3.88 MHz / 3.28 MHz	CBE	30	C-3	Measure V7, the output amplitude (Vp-p) for an input chroma (CW) frequency of 3.28 MHz, and V8, the same for 3.88 MHz, and substitute in the following formula. $CBE = 20\log(V8/V7)$	CHR.BPF : 0
Band pass amplitude characteristic 4.08 MHz / 3.08 MHz	CBE05	30	C-3	Measure V9, the output amplitude (Vp-p) for an input chroma (CW) frequency of 4.08 MHz, and substitute in the following formula. $CBE05 = 20\log(V9/V6)$	CHR.BPF : 0

Continued on next page.

## LA76075

Continued from preceding page.

Item	Symbol	Measurement Point	Input Signal	Measurement Procedure	Bus Condition
[Video Block]					
Overall video gain	PIX127	30	L-50	Measure CNTHB, the 50 IRE amplitude (Vp-p) of the output signal, and substitute in the following formula. $PIX127 = 20\log(CNTHB/0.357)$	Pix : 1111111
Contrast adjustment characteristic (Normal/max)	PIX63	30	L-50	Measure CNTCB, the 50 IRE amplitude (Vp-p) of the output signal, and substitute in the following formula. $PIX63 = 20\log(CNTCB/0.357)$	Pix : 0111111
Contrast adjustment characteristic (Min/max)	PIX0	30	L-50	Measure CNTCB, the 50 IRE amplitude (Vp-p) of the output signal, and substitute in the following formula. $PIX = 20\log(CNTLB/0.357)$	Pix : 0000000
Video frequency characteristic f0 = 1(Sharp0)	Yf02	30	L-CW	Measure PEAKDC, the CW output signal amplitude (Vp-p) for an input signal with CW = 100 kHz.	FO Select 01
f0 = 2(Sharp15)				Measure F02, the CW output signal amplitude (Vp-p) for an input signal with CW = 8 MHz. $Yf02 = 20\log(F00/PEAKDC)$	FO Select : 10 Sharpness : 01111
Chroma trapping f0 = 0(Sharp0)	Ctrap	30	L-CW	Measure F00, the CW output signal amplitude (Vp-p) for an input signal with CW = 3.58 MHz. $Ctrap = 20\log(F00/PEAKDC)$	FO Select : 00 Sharpness : 00000
DC propagation	ClampG	30	L-0	Measure BRTPL, the 0 IRE DC level (V) of the output signal.	Brightness : 0000000 Pix : 1111111
			L-100	Measure DRVPH, the 0 IRE DC level (V) of the output signal, and DRVH, the 100 IRE output signal amplitude (Vp-p), and substitute in the following formula. $ClampG = 100 \times (1 + (DRVPH-BRTPL)/DRIVH)$	Brightness : 0000000 Pix : 1111111
Y delay f0 = 1	YDLY	30	L-50	Measure the time lag (delay) between the input signal and the output signal for the rising edge of the 50 IRE amplitude.	
Maximum black stretching gain	BKSTmax	30	L-BK	Measure BKST1, the 0 IRE DC level (V) at point A of the output signal with the black stretching function off.	Blk Str DEF : 0
				Measure BKST2, the 0 IRE DC level (V) at point A of the output signal with the black stretching function on. $BKS\ T_{max} = 2 \times 50 \times (BKST1-BKST2)/CNTHB$	
Black stretching threshold (40 IRE $\Delta$ black)	BKST <sub>TH</sub> $\Delta$	30	L-40	Measure BKST3, the 40 IRE DC level (V) of the output signal with the black stretching function on.	Blk Str DEF : 0
				Measure BKST4, the 0 IRE DC level (V) of the output signal with the black stretching function off. $BKST_{TH\Delta} = 50 \times (BKST4-BKST3)/CNTHB$	
Sharpness (peaking) variable characteristic (normal)	Sharp16	30	L-CW	Measure F00S16, the CW output signal amplitude (Vp-p) for an input signal with CW = 2.2 MHz. $Sharp16 = 20\log(F00S16/PEAKDC)$	F0 Select : 00 Sharpness : 10000
	(max) Sharp31		L-CW	Measure F00S31, the CW output signal amplitude (Vp-p) for an input signal with CW = 2.2 MHz. $Sharp31 = 20\log(F00S16/PEAKDC)$	Sharpness : 11111
	(min) Sharp0		L-CW	Measure F00S0, the CW output signal amplitude (Vp-p) for an input signal with CW = 2.2 MHz. $Sharp0 = 20\log(F00S0/PEAKDC)$	Sharpness : 00000
Coring characteristic	Coring	30	L-CW	Measure the CW output signal amplitude (Vp-p) for an input signal with CW = 2.7 MHz twice with coring off (A) and then on (B). $Coring = 20\log(A/B)$	F0 Select : 01 Sharpness : 11111 Coring : off, On
Horizontal/vertical blanking output level	RGB <sub>BLK</sub>	30	L-100	Measure RGB <sub>BLK</sub> , the DC level (V) for an output signal blanking period.	

Continued on next page.

**Video Block Input Signals and Measurement Conditions**

1. CIN input signal: Chroma burst signal, 40 IRE
2. YIN input signal: 100 IRE, 714 mV
3. Bus control register bits: initial test state

0 IRE signal (L-0): NTSC standard synchronization signal

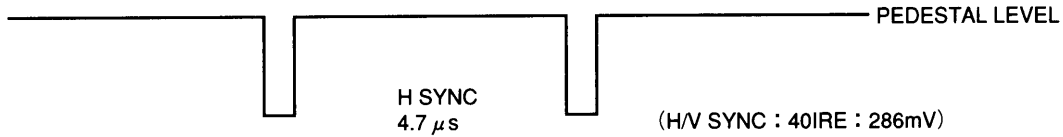

A10012

XIRE signal (L-X)

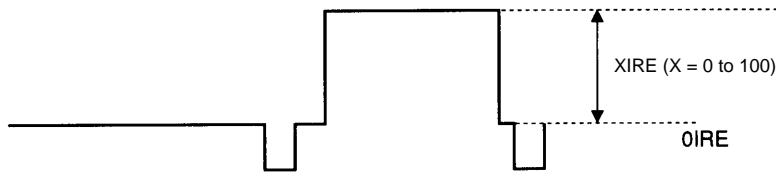

A10013

CW signal (L-CW)

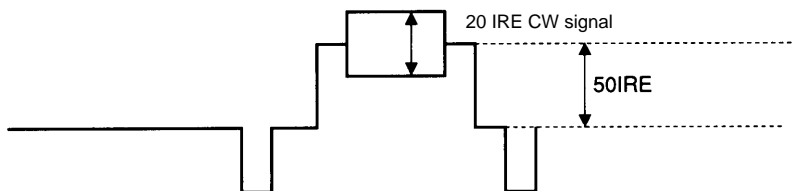

A10014

Black stretch 0 IRE signal (L-BK)

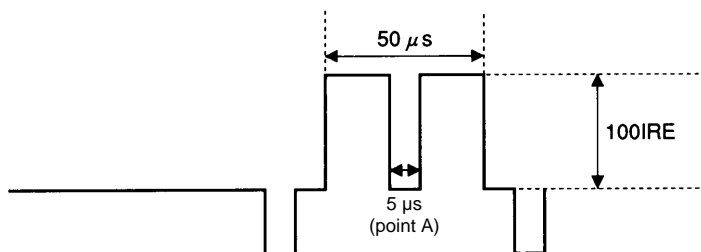

A10015

RIN, GIN, BIN input signals

RGB input signal 1 [0-1]

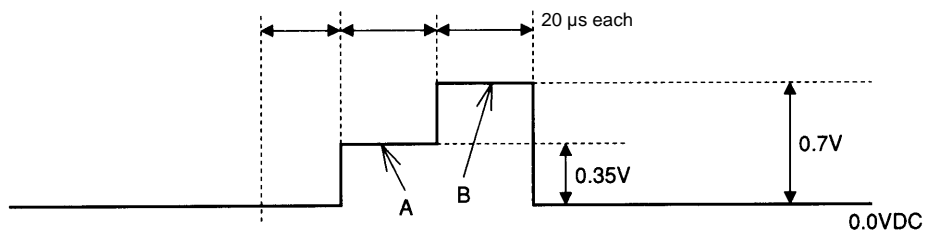

A10016

RGB input signal 2 [0-2]

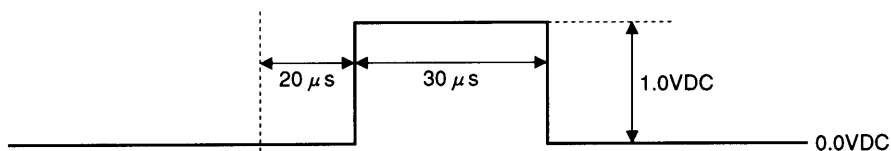

A10017

## LA76075

Item	Symbol	Measurement Point	Input Signal	Measurement Procedure	Bus Condition
[On Screen Display (OSD) Block]				For the following measurements, set both the pix and brightness bus bits to 63.	Pix : 0111111 Brightness : 0111111
OSD Fast Switch threshold	F <sub>STH</sub>	30	L-0 0-2	Gradually raise the voltage at pin 36 from 0 V and note the voltage at which the output signal switches to the OSD signal.	Apply 0-2 to pin 35.
Red RGB output level	R <sub>OSDH</sub>	28	L-50	Measure CNTCR, the 50 IRE amplitude (Vp-p) of the output signal.	
			L-0 0-2	Measure OSDHR, the OSD output amplitude (Vp-p).	pin 36 : 3.5 V Apply 0-2 to pin 33.
				$R_{OSDH} = 50 \times (OSDHR/CNTCR)$	
Green RGB output level	G <sub>OSDH</sub>	29	L-50	Measure CNTCG, the 50 IRE amplitude (Vp-p) of the output signal.	
			L-0 0-2	Measure OSDHG, the OSD output amplitude (Vp-p).	pin 36 : 3.5 V Apply 0-2 to pin 33.
				$G_{OSDH} = 50 \times (OSDHG/CNTCG)$	
Blue RGB output level	B <sub>OSDH</sub>	30	L-50	Measure CNTCB, the 50 IRE amplitude (Vp-p) of the output signal.	
			L-0 0-2	Measure OSDHB, the OSD output amplitude (Vp-p).	pin 36 : 3.5 V Apply 0-2 to pin 33.
				$B_{OSDH} = 50 \times (OSDHB/CNTCB)$	
Analog OSD Red output level		28	L-0 0-1	Measure REGLR, the output amplitude (Vp-p) at point A of the output signal, and RGBHR, the same at point B. Note: Point A corresponds to the 0.35-V point in the input signal 0-1 [?]; point B, to the 0.7-V point.	pin 36 : 3.5 V Apply 0-1 to pin 33.
Gain match	R <sub>RGB</sub>			$R_{RGB} = RGBLR/CNTCR$	
Linearity	LR <sub>RGB</sub>			$LR_{RGB} = 100 \times (RGBLR/RGBHR)$	
Analog OSD Green output level		29	L-0 0-1	Measure RGBLG, the output amplitude (Vp-p) at point A of the output signal, and RGBHG, the same at point B. Note: Point A corresponds to the 0.35-V point in the input signal 0-1 [?]; point B, to the 0.7-V point.	pin 36 : 3.5 V Apply 0-1 to pin 34.
Gain match	G <sub>RGB</sub>			$G_{RGB} = RGBLR/CNTCG$	
Linearity	LG <sub>RGB</sub>			$LG_{RGB} = 100 \times (RGBLG/RGBHG)$	
Analog OSD Blue output level		30	L-0 0-1	Measure RGBLB, the output amplitude (Vp-p) at point A of the output signal, and RGBHB, the same at point B. Note: Point A corresponds to the 0.35-V point in the input signal 0-1 [?]; point B, to the 0.7-V point.	pin 36 : 3.5 V Apply 0-1 to pin 35.
Gain match	B <sub>RGB</sub>			$B_{RGB} = RGBLB/CNTCG$	
Linearity	LB <sub>RGB</sub>			$LB_{RGB} = 100 \times (RGBLB/RGBHB)$	
[RGB Output (Cutoff, Drive) Block]				For the following measurements, set the pix bus bits to 127.	Pix : 1111111
Brightness control (normal)	BRT63	28	L-0	Measure BRTPCR, BRTPCG, and BRTPCB, the 0 IRE DC output levels (V) at pins 28 (RED OUT), 29 (GRN OUT), and 30 (BLU OUT).	Brightness : 0111111
		29			
		30			
				$BRT63 = (BRTPCR + BRTPCG + BRTPCB)/3$	
(max)	BRT127	30		Measure BRTPHB, the 0 IRE DC output level (V) at pin 30 (BLU OUT).	Brightness : 1111111
				$BRT127 = 50 \times (BRTPHB - BRTPCB)/CNTHB$	
(min)	BRT0			Measure BRTPLB, the 0 IRE DC output level (V) at pin 30 (BLU OUT).	Brightness : 0000000
				$BRT0 = 50 \times (BRTPLB - BRTPCB)/CNTHB$	

Continued on next page.



LA76075

Continued from preceding page.

Item	Symbol	Measurement Point	Input Signal	Measurement Procedure	Bus Condition
[RGB Output (Cutoff, Drive) Block]				For the following measurements, set the pix bus bits to 127.	Pix : 1111111
Bias (cutoff) control (min)	Vbias0	<div style="display: flex; flex-direction: column; align-items: center;"> <div style="border: 1px solid black; padding: 2px; margin: 2px;">28</div> <div style="border: 1px solid black; padding: 2px; margin: 2px;">29</div> <div style="border: 1px solid black; padding: 2px; margin: 2px;">30</div> </div>	L-50	Measure Vbias0* (where * = R, G, B), the 0 IRE DC output levels (V) at pins 28 (RED OUT), 29 (GRN OUT), and 30 (BLU OUT).	Sub-Brightness : 0000000
(max)	Vbias128			Measure Vbias128* (where * = R, G, B), the 0 IRE DC output levels (V) at pins 28 (RED OUT), 29 (GRN OUT), and 30 (BLU OUT).	Sub-Brightness : 1111111 Red/Green/Blue Bias : 1111111
Bias (cutoff) control resolution	Vbiassns			Measure BAS80* (where * = R, G, B), the 0 IRE DC output levels (V) at pins 28 (RED OUT), 29 (GRN OUT), and 30 (BLU OUT).	Red/Green/Blue Bias : 1010000
				Measure BAS48* (where * = R, G, B), the 0 IRE DC output levels (V) at pins 28 (RED OUT), 29 (GRN OUT), and 30 (BLU OUT).	Red/Green/Blue Bias : 0110000
				$Vbiassns* = (BAS80)* - BAS48*/32$	
Sub bias control resolution	Vsbiassns	L-50	Measure SBTPM* (where* = R, G, B), the 0 IRE DC output levels (V) at pins 28 (RED OUT), 29 (GRN OUT), and 30 (BLU OUT).	Red/Green/Blue Bias : 0101010 Pix : 0111111	
				$Vsbiassns* = (BRTPC* - SBTPM8*)$	
Drive adjustment maximum output	RGBout127	<div style="border: 1px solid black; padding: 2px; margin: 2px;">28</div>	L-100	Measure DRVH* (where * = R, G, B), the 100 IRE DC output amplitude (Vp-p) at pins 28 (RED OUT), 29 (GRN OUT), and 30 (BLU OUT).	Brightness : 0000000
Drive adjustment output attenuation	RGBout0	<div style="border: 1px solid black; padding: 2px; margin: 2px;">29</div> <div style="border: 1px solid black; padding: 2px; margin: 2px;">30</div>		Measure DRVL* (where * = R, B), the 100 IRE DC output amplitude (Vp-p) at pins 28 (RED OUT), 29 (GRN OUT), and 30 (BLU OUT).	Brightness : 0000000 Red/Blue Deive : 0000000
				$RGBout0* = 20\log(DRVH*/DRVL*)$	
				For the following measurements, set both the pix and brightness bus bits to 63.	Pix : 0111111 Brightness : 01111111
Gamma characteristic	R $\gamma$	<div style="border: 1px solid black; padding: 2px; margin: 2px;">28</div>	L-100	Measure *A and *B (where * = R, G, B), the 100 IRE DC output amplitude (Vp-p) at pins 28 (RED OUT), 29 (GRN OUT), and 30 (BLU OUT) with gamma def off (*A) and then on (*B).	Gamma Def : Off, On
	G $\gamma$	<div style="border: 1px solid black; padding: 2px; margin: 2px;">29</div>			
	B $\gamma$	<div style="border: 1px solid black; padding: 2px; margin: 2px;">30</div>			
				$*\gamma = 100 * (*A/*B)$	

**Deflection Block Input Signals and Measurement Conditions**

If nothing is specified for the items, the following conditions apply.

1. VIF and SIF blocks: No signals
2. C input: No signal
3. Y input: Supply a composite horizontal and vertical synchronization signal (40 IRE). Set other timing parameters to conform with the FCC broadcast standard.

Note: Make sure that there are no burst or chroma signals under the pedestal level.

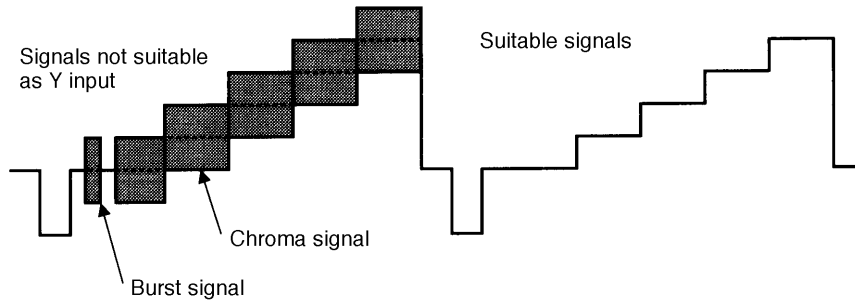

A10018

4. Bus control conditions: Use the initial values.
5. Use a delay of 9  $\mu$ s from the rising edge in the horizontal output (pin 23) to the rising edge in the flyback pulse pin (pin 24).
6. Connect pin 32, the vertical size compensation circuit input pin to  $V_{CC}$  (7.6 V).
7. Connect pin 25 (X RAY), the X-ray protection circuit input pin to ground.

Item	Symbol	Measurement Point	Input Signal	Measurement Procedure	Bus Condition
[Deflection block]					
Synchronization separation sensitivity	Ssync	38	YIN: Composite horizontal and vertical synchronization signal	Gradually lower the pin 38 (YIN) synchronization signal level and measure the level at which the device loses synchronization.	
Horizontal free run frequency deviation	$\Delta fH$	23	YIN: No signal	Connect a frequency counter to the pin 23 (HORIZ OUT) output, measure the horizontal free run frequency, and substitute in the following formula. $\Delta fH = \text{the measured frequency} - 15.734 \text{ kHz}$	
Horizontal pull-in range	fH PULL	38	YIN: Composite horizontal and vertical synchronization signal	Connect the pin 38 (YIN) synchronization signal input and pin 23 (HORIZ OUT) output to an oscilloscope, vary the horizontal synchronization signal frequency, and measure the pull-in range.	
Horizontal output pulse width @0	Hduty 0	23	YIN: Composite horizontal and vertical synchronization signal	Measure the width of the "Low" level portion of the pin 23 (HORIZ OUT) horizontal output pulses.	HDUTY : 00
Horizontal output pulse width @1	Hduty 1	23	YIN: Composite horizontal and vertical synchronization signal	Measure the width of the "Low" level portion of the pin 23 (HORIZ OUT) horizontal output pulses.	HDUTY : 01
Horizontal output pulse saturation voltage	V Hsat	23	YIN: Composite horizontal and vertical synchronization signal	Measure the voltage of the "Low" level portion of the pin 23 (HORIZ OUT) horizontal output pulses.	

Continued on next page.

## LA76075

Continued from preceding page.

Item	Symbol	Measurement Point	Input Signal	Measurement Procedure	Bus Condition
Horizontal output pulse phase	HPHCEN	23 38	YIN: Composite horizontal and vertical synchronization signal	<p>Measure the delay from the rising edge of the pin 23 (HORIZ OUT) horizontal output pulses to the falling edge of the pin 38 (YIN) horizontal synchronization signal input.</p> <p style="text-align: right;">A10019</p>	
Horizontal position adjustment range	HPHrange	23 38	YIN: Composite horizontal and vertical synchronization signal	<p>Vary H<sub>PHASE</sub> over the range 0 to 31, measure the delays from the rising edge of the pin 23 (HORIZ OUT) horizontal output pulses to the falling edge of the pin 38 (YIN) horizontal synchronization signal input, and calculate the differences from H<sub>PHCEN</sub>.</p> <p style="text-align: right;">A10020</p>	<p>H<sub>PHASE</sub> : 00000</p> <p>H<sub>PHASE</sub> : 11111</p>
Horizontal position adjustment maximum range	HPHstep	23 38	YIN: Composite horizontal and vertical synchronization signal	<p>Vary H<sub>PHASE</sub> over the range 0 to 31, measure the delays from the rising edge of the pin 23 (HORIZ OUT) horizontal output pulses to the falling edge of the pin 38 (YIN) horizontal synchronization signal input, calculate the change at each step, and take the maximum.</p> <p style="text-align: right;">A10021</p>	<p>H<sub>PHASE</sub> : 00000</p> <p>H<sub>PHASE</sub> : 11111</p>
Operating voltage for X-ray protection circuit	VXRAY	23 25	YIN: Composite horizontal and vertical synchronization signal	<p>Connect a DC power supply to pin 25 (X RAY), gradually raise the voltage from 0 V, and measure the DC voltages at the point where the horizontal output pulses from pin 23 (HORIZ OUT) stop.</p>	

Continued on next page.

LA76075

Continued from preceding page.

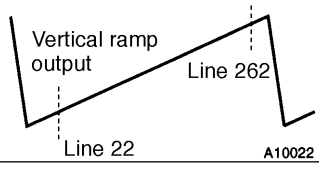
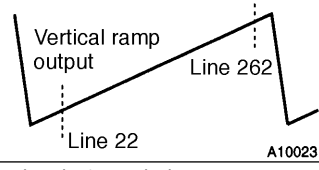
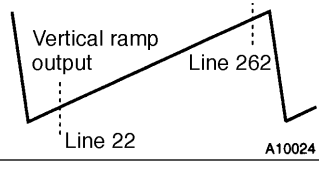
Item	Symbol	Measurement Point	Input Signal	Measurement Procedure	Bus Condition
[Vertical screen size adjustment]					
Vertical ramp output amplitude @64	Vsize64	17	YIN: Composite horizontal and vertical synchronization signal	Monitor the pin 17 vertical ramp output, measure the voltages for lines 22 and 262, and substitute in the following formula. $V_{size64} = V_{line262} - V_{line22}$ 	
Vertical ramp output amplitude @0	Vsize0	17	YIN: Composite horizontal and vertical synchronization signal	Monitor the pin 17 vertical ramp output, measure the voltages for lines 22 and 262, and substitute in the following formula. $V_{size0} = V_{line262} - V_{line22}$ 	VSIZ0 : 0000000
Vertical ramp output amplitude @127	Vsize127	17	YIN: Composite horizontal and vertical synchronization signal	Monitor the pin 17 vertical ramp output, measure the voltages for lines 22 and 262, and substitute in the following formula. $V_{size127} = V_{line262} - V_{line22}$ 	VSIZ127 : 1111111
[High-voltage dependent vertical size compensation]					
Vertical size compensation @0	Vsizecomp	17	YIN: Composite horizontal and vertical synchronization signal	Monitor the pin 17 vertical ramp output, measure the voltages for lines 22 and 262, and substitute in the following formula. Apply 6.2 V to pin 32, repeat the measurements, and substitute in the following two formulas.	VCOMP : 00

Continued on next page.

## LA76075

Continued from preceding page.

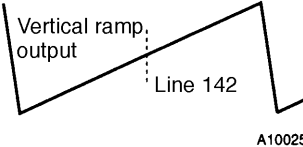
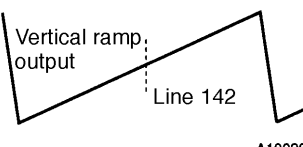
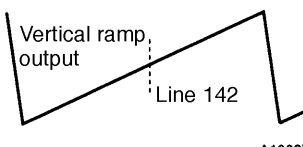
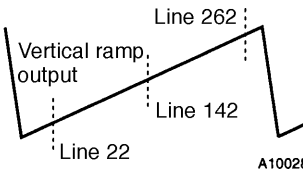
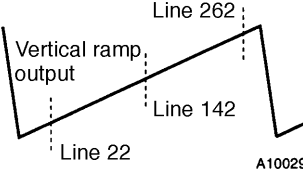
Item	Symbol	Measurement Point	Input Signal	Measurement Procedure	Bus Condition
[Vertical screen position adjustment]					
Vertical ramp DC voltage @64	Vdc64	17	YIN: Composite horizontal and vertical synchronization signal	Monitor the pin 17 vertical ramp output and measure the voltage for line 142. 	
Vertical ramp DC voltage @0	Vdc0	17	YIN: Composite horizontal and vertical synchronization signal	Monitor the pin 17 vertical ramp output and measure the voltage for line 142. 	VDC : 0000000
Vertical ramp DC voltage @127	Vdc127	17	YIN: Composite horizontal and vertical synchronization signal	Monitor the pin 17 vertical ramp output and measure the voltage for line 142. 	VDC : 1111111
Vertical linearity @16	Vlin16	17	YIN: Composite horizontal and vertical synchronization signal	Monitor the pin 17 vertical ramp output, measure the voltages for lines 22 (Va), 142 (Vb), and 262 (Vc), and substitute in the following formula. $Vlin16 = (Vb - Va)/(Vc - Vb)$ 	
Vertical linearity	Vlin0	17	YIN: Composite horizontal and vertical synchronization signal	Monitor the pin 17 vertical ramp output, measure the voltages for lines 22 (Va), 142 (Vb), and 262 (Vc), and substitute in the following formula. $Vlin16 = (Vb - Va)/(Vc - Vb)$ 	VLIN : 00000

Continued on next page.

LA76075

Continued from preceding page.

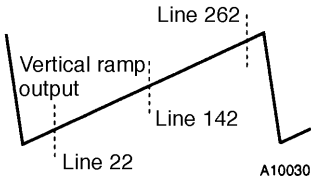
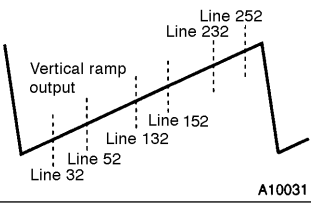
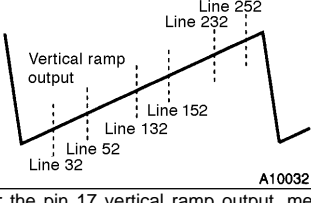
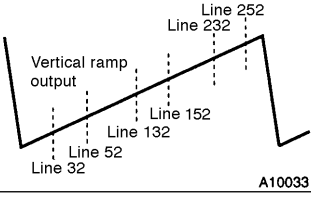
Item	Symbol	Measurement Point	Input Signal	Measurement Procedure	Bus Condition
Vertical linearity @31	Vlin31	17	YIN: Composite horizontal and vertical synchronization signal	<p>Monitor the pin 17 vertical ramp output, measure the voltages for lines 22 (Va), 142 (Vb), and 262 (Vc), and substitute in the following formula.  <math>Vlin31 = (Vb - Va)/(Vc - Va)</math></p> 	VLIN : 11111
Vertical S-correction @16	VScor16	17	YIN: Composite horizontal and vertical synchronization signal	<p>Monitor the pin 17 vertical ramp output, measure the voltages for lines 32 (Va), 52 (Vb), 132 (Vc), 152 (Vd), 232 (Ve), and 252 (Vf), and substitute in the following formula.  <math>VScor16 = 0.5 ((Vb - Va) + (Vf - Ve))/(Vd - Vc)</math></p> 	VS : 10000
Vertical S-correction @0	VScor0	17	YIN: Composite horizontal and vertical synchronization signal	<p>Monitor the pin 17 vertical ramp output, measure the voltages for lines 32 (Va), 52 (Vb), 132 (Vc), 152 (Vd), 232 (Ve), and 252 (Vf), and substitute in the following formula.  <math>VScor0 = 0.5 ((Vb - Va) + (Vf - Ve))/(Vd - Vc)</math></p> 	
Vertical S-correction @31	VScor31	17	YIN: Composite horizontal and vertical synchronization signal	<p>Monitor the pin 17 vertical ramp output, measure the voltages for lines 32 (Va), 52 (Vb), 132 (Vc), 152 (Vd), 232 (Ve), and 252 (Vf), and substitute in the following formula.  <math>VScor31 = 0.5 ((Vb - Va) + (Vf - Ve))/(Vd - Vc)</math></p> 	VS : 11111

Continued on next page.

LA76075

Continued from preceding page.

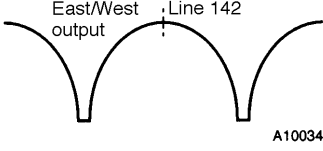
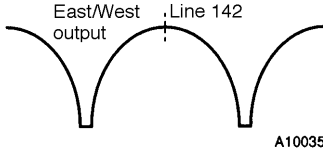
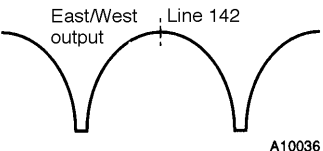
Item	Symbol	Measurement Point	Input Signal	Measurement Procedure	Bus Condition
[Horizontal size adjustment]					
East/West DC voltage @32	EWdc32	18	YIN: Composite horizontal and vertical synchronization signal	Monitor the pin 18 East/West (parabola wave) output and measure the voltage for line 142. 	
East/West DC voltage @0	EWdc0	18	YIN: Composite horizontal and vertical synchronization signal	Monitor the pin 18 East/West (parabola wave) output and measure the voltage for line 142. 	EWDC : 000000
East/West DC voltage @63	EWdc63	18	YIN: Composite horizontal and vertical synchronization signal	Monitor the pin 18 East/West (parabola wave) output and measure the voltage for line 142. 	EWDC : 111111
[High-voltage dependent horizontal size compensation]					
Horizontal size compensation @0	Hsizecomp	18	YIN: Composite horizontal and vertical synchronization signal	Monitor the pin 18 East/West output and measure the voltage (Va) for line 142. Apply 6.2 V to pin 32, measure the voltage for line 142 again (Vb), and substitute in the following two formulas. $Hsizecomp = Va - Vb$	HCOMP : 000

Continued on next page.

LA76075

Continued from preceding page.

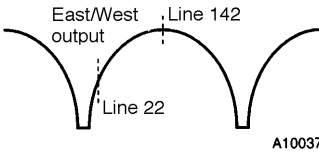
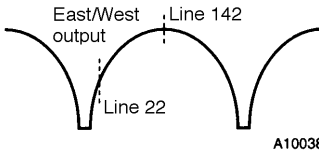
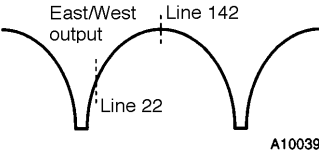
Item	Symbol	Measurement Point	Input Signal	Measurement Procedure	Bus Condition
[Pincushion distortion compensation]					
East/West parabola amplitude @32	EWamp32	18	YIN: Composite horizontal and vertical synchronization signal	Monitor the pin 18 East/West (parabola wave) output, measure the voltages for lines 22 (Va) and 142 (Vb), and substitute in the following formula. $EWamp32 = Vb - Va$ 	
East/West parabola amplitude @0	EWamp0	18	YIN: Composite horizontal and vertical synchronization signal	Monitor the pin 18 East/West (parabola wave) output, measure the voltages for lines 22 (Va) and 142 (Vb), and substitute in the following formula. $EWamp0 = Vb - Va$ 	EWAMP000000
East/West parabola amplitude @63	EWamp63	18	YIN: Composite horizontal and vertical synchronization signal	Monitor the pin 18 East/West (parabola wave) output, measure the voltages for lines 22 (Va) and 142 (Vb), and substitute in the following formula. $EWamp63 = Vb - Va$ 	EWAMP111111

Continued on next page.



## LA76075

Continued from preceding page.

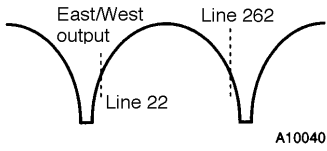
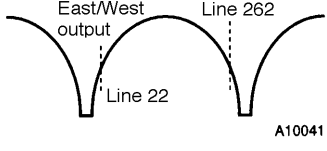
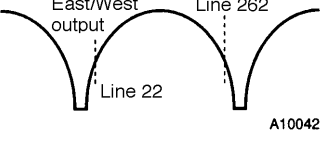
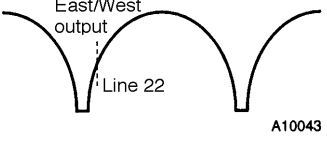
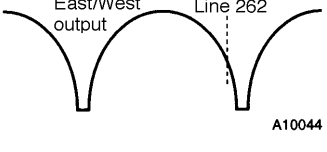
Item	Symbol	Measurement Point	Input Signal	Measurement Procedure	Bus Condition
[Keystone distortion compensation]					
East/West parabola tilt @32	EWtilt32	18	YIN: Composite horizontal and vertical synchronization signal	Monitor the pin 18 East/West (parabola wave) output, measure the voltages for lines 22 (Va) and 262 (Vb), and substitute in the following formula. $EWtilt32 = Va - Vb$ 	
East/West parabola tilt @0	EWtilt0	18	YIN: Composite horizontal and vertical synchronization signal	Monitor the pin 18 East/West (parabola wave) output, measure the voltages for lines 22 (Va) and 262 (Vb), and substitute in the following formula. $EWtilt0 = Va - Vb$ 	WTILT : 000000
East/West parabola tilt @63	EWtilt63	18	YIN: Composite horizontal and vertical synchronization signal	Monitor the pin 18 East/West (parabola wave) output, measure the voltages for lines 22 (Va) and 262 (Vb), and substitute in the following formula. $EWtilt63 = Va - Vb$ 	WTILT : 111111
[Corner distortion compensation]					
East/West parabola corner top	EWcortop	18	YIN: Composite horizontal and vertical synchronization signal	Monitor the pin 18 East/West (parabola wave) output, measure the voltage for line 22 under the conditions: CORTOP = 1111 (Va) and CORTOP = 0000 (Vb), and substitute in the following formula. $EWcortop = Va - Vb$ 	CORTOP : 1111-0000
East/West parabola corner bottom	EWcorbot	<input type="checkbox"/>	YIN: Composite horizontal and vertical synchronization signal	Monitor the pin 18 East/West (parabola wave) output, measure the voltage for line 262 under the conditions: CORTOP = 1111 (Va) and CORTOP = 0000 (Vb), and substitute in the following formula. $EWcorbot = Va - Vb$ 	CORBOTTOM : 1111-0000

# LA76075

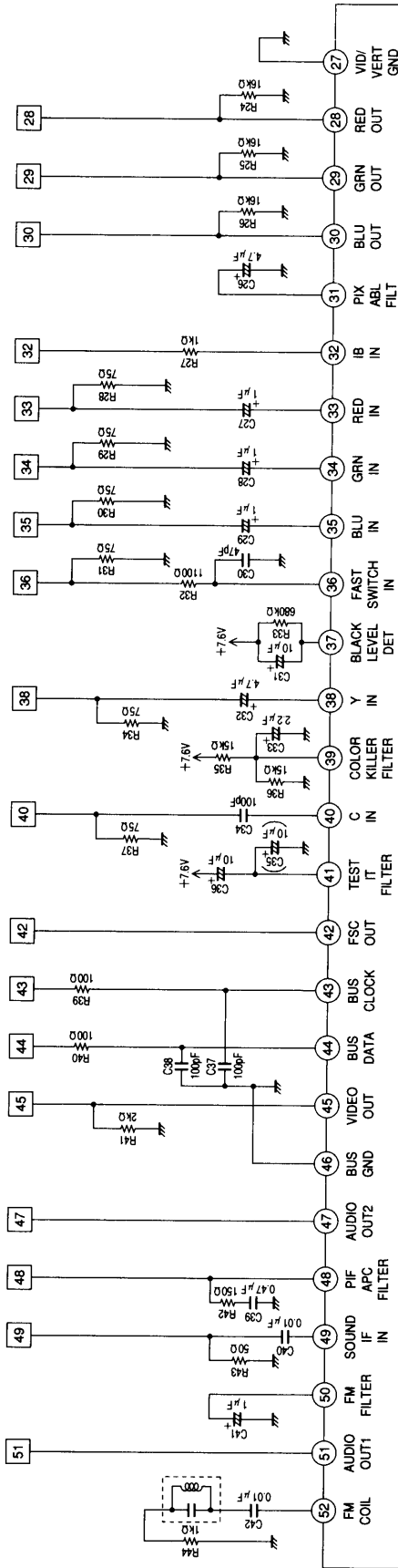

# LA76075

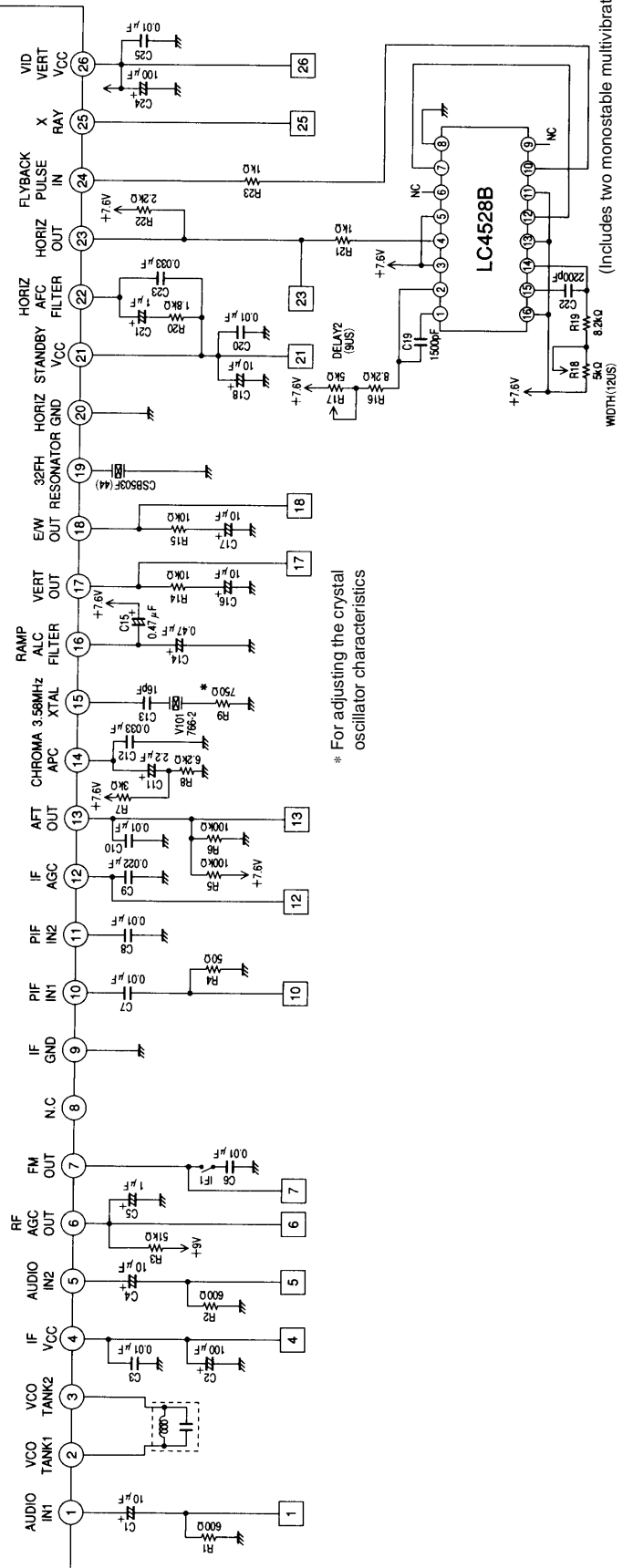

\* For adjusting the crystal oscillator characteristics

(Includes two monostable multivibrators)  
A10045

- Specifications of any and all SANYO products described or contained herein stipulate the performance, characteristics, and functions of the described products in the independent state, and are not guarantees of the performance, characteristics, and functions of the described products as mounted in the customer's products or equipment. To verify symptoms and states that cannot be evaluated in an independent device, the customer should always evaluate and test devices mounted in the customer's products or equipment.
- SANYO Electric Co., Ltd. strives to supply high-quality high-reliability products. However, any and all semiconductor products fail with some probability. It is possible that these probabilistic failures could give rise to accidents or events that could endanger human lives, that could give rise to smoke or fire, or that could cause damage to other property. When designing equipment, adopt safety measures so that these kinds of accidents or events cannot occur. Such measures include but are not limited to protective circuits and error prevention circuits for safe design, redundant design, and structural design.
- In the event that any or all SANYO products (including technical data, services) described or contained herein are controlled under any of applicable local export control laws and regulations, such products must not be exported without obtaining the export license from the authorities concerned in accordance with the above law.
- No part of this publication may be reproduced or transmitted in any form or by any means, electronic or mechanical, including photocopying and recording, or any information storage or retrieval system, or otherwise, without the prior written permission of SANYO Electric Co., Ltd.
- Any and all information described or contained herein are subject to change without notice due to product/technology improvement, etc. When designing equipment, refer to the "Delivery Specification" for the SANYO product that you intend to use.
- Information (including circuit diagrams and circuit parameters) herein is for example only; it is not guaranteed for volume production. SANYO believes information herein is accurate and reliable, but no guarantees are made or implied regarding its use or any infringements of intellectual property rights or other rights of third parties.

This catalog provides information as of October, 1998. Specifications and information herein are subject to change without notice.