

SANYO

No. 5097

LA7668N**Video Signal Auto-White Processing IC****Overview**

The LA7668N is a low-cost video signal auto-white processing IC that provides brightness adapted compression and expansion functions. Furthermore, the LA7668N incorporates on-chip a Sanyo developed vertical line saturation suppression function for image quality enhancement.

Features and Functions

- APL; frequency adaptive Y/C correction
- Vertical line saturation suppression function
- Correction circuit on/off function
- Built-in synchronization/burst gate separation circuit
- 4.0 V band gap Zener output
- Variable correction curve (using an external resistor)

Package Dimensions

unit: mm

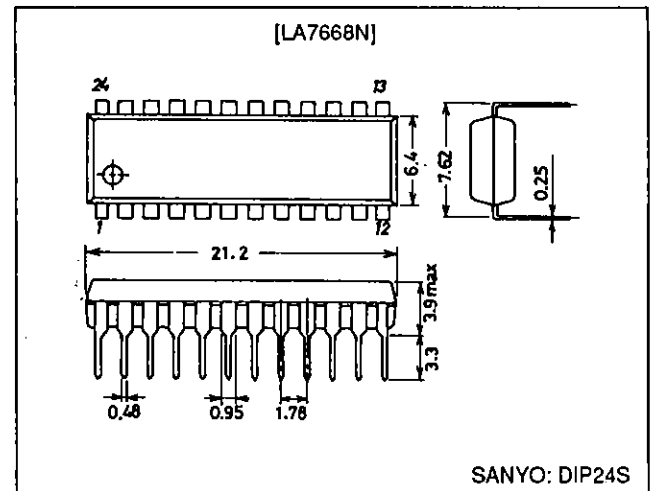
3067-DIP24S**Specifications**Maximum Ratings at $T_a = 25^\circ\text{C}$

Parameter	Symbol	Conditions	Ratings	Unit
Maximum supply voltage	$V_{CC \text{ max}}$		7.0	V
Allowable power dissipation	$P_d \text{ max}$	$T_a \leq 65^\circ\text{C}$	200	mW
Operating temperature	T_{opr}		-10 to +65	$^\circ\text{C}$
Storage temperature	T_{stg}		-55 to +125	$^\circ\text{C}$

Operating Conditions at $T_a = 25^\circ\text{C}$

Parameter	Symbol	Conditions	Ratings	Unit
Recommended supply voltage	V_{CC}		5.0	V
Operating supply voltage range	$V_{CC \text{ OP}}$		4.5 to 5.5	V

Electrical Characteristics at $T_a = 25^\circ\text{C}$, $V_{CC} = 5.0 \text{ V}$

Parameter	Symbol	Conditions	min	typ	max	Unit
Current drain (off)	I_{OFF}	Pin 17 = 5 V, no input	16.0	20.0	25.0	mA
Current drain (on)	I_{ON}	Pin 17 = 0 V, no input	18.0	22.0	28.0	mA
BGZ output 1	V_{BGZ1}	$I_{OUT} = 3 \text{ mA}$	3.7	4.0	4.3	V
BGZ output 2	V_{BGZ2}	$I_{OUT} = 3 \text{ mA}$, $V_{CC} = 4.5 \text{ V}$	3.65	4.0	4.3	V
BGZ maximum output current	I_{OMAX}	$V_{CC} = 4.5 \text{ V}$	5.0	8.0		mA

Continued on next page.

LA7668N

Continued from preceding page.

Parameter	Symbol	Conditions	min	typ	max	Unit
[Luminance Signal System]						
Voltage gain	V_{GY}	$V_{IN} = 1.0$ Vp-p	6.0	6.5	7.0	dB
Frequency characteristics	f_Y	When 3 dB down from the 1 MHz output level	7.0	8.5		MHz
Signal input level	V_{IY}			1.0	1.2	Vp-p
Output DC level	V_{OYDC}	Pedestal level	0.7	0.9	1.1	V
Pin 18 output	V_{18}		1.75	2.0	2.25	V
γ characteristics 90	$\Delta_{\gamma 90}$	APL = 90%, $V_{IN} = 100$ IRE	101	105	109	IRE
γ characteristics 50	$\Delta_{\gamma 50}$	APL = 50%, $V_{IN} = 40$ IRE	41	45	49	IRE
γ characteristics 10-1	$\Delta_{\gamma 10-1}$	APL = 10%, $V_{IN} = 80$ IRE	81	85	89	IRE
γ characteristics 10-2	$\Delta_{\gamma 10-2}$	APL = 10%, $V_{IN} = 40$ IRE	43	47	52	IRE
[Chrominance Signal System]						
Voltage gain	V_{GC}	$V_{IN} = 0.66$ Vp-p	6.3	6.8	7.2	dB
Maximum gain	V_{GMAX}	When $f = 3.58$ MHz, APL = 0%	7.3	7.8	8.3	dB
Minimum gain	V_{GMIN}	When $f = 3.58$ MHz, APL = 100%	5.7	6.2	6.7	dB
Frequency characteristics	f_C	When 3 dB down from the 1 MHz output level	4.0	5.0		MHz
Signal input level	V_{IC}			0.66	0.8	Vp-p
Output DC level	V_{OCDL}		1.1	1.4	1.7	V
[Control System]						
Mute on voltage	V_{ON}		1.0		V_{CC}	V
Mute off voltage	V_{OFF}		0		0.5	V
Pin 2 voltage	V_2		2.81	3.2	3.61	V
Pin 4 voltage	V_3		2.72	3.1	3.50	V
Pin 11 voltage	V_{11}		2.19	2.5	2.82	V
Pin 14 voltage	V_{14}		2.29	2.6	2.94	V
Pin 15 voltage	V_{15}		2.11	2.4	2.71	V
Pin 16 voltage	V_{16}		2.02	2.3	2.60	V
Pin 21 voltage	V_{21}		2.54	2.9	3.27	V
Pin 23 voltage	V_{23}		2.02	2.3	2.60	V

Pin Functions

Pin No.	Symbol	Function
1	L_{PF_D}	Correction signal frequency control
2	H_U	Correction reference voltage (3.2 V)
3	Y_{IN}	Luminance signal input
4	H_D	Correction reference voltage (3.1 V)
5	SYNC	Sync separator input
6	V_{CC}	Power supply
7	BGP	BGP delay time constant
8	APL_{DET}	APL level detection filter
9	HPF_{IN}	High-frequency detection filter (input)
10	HPF_{OUT}	High-frequency detection filter (output)
11	HE_{DET}	High-frequency detection circuit control voltage
12	C_{IN}	Chrominance signal input
13	C_{OUT}	Chrominance signal output
14	APL_H	APL discrimination reference voltage (high)
15	APL_{L1}	APL discrimination reference voltage (low)
16	APL_{L2}	APL discrimination reference voltage (for the high-frequency detection circuit)
17	MUTE	Correction circuit muting
18	2.0VBIAS	Luminance signal system bias
19	GND	Ground
20	BGZ_{OUT}	4.0 V BGZ voltage output
21	L_D	Correction reference voltage (2.9 V)
22	Y_{OUT}	Luminance signal output
23	L_U	Correction reference voltage (2.3 V)
24	L_{PF_U}	Correction signal frequency control

LA7668N

Application Circuit Diagram

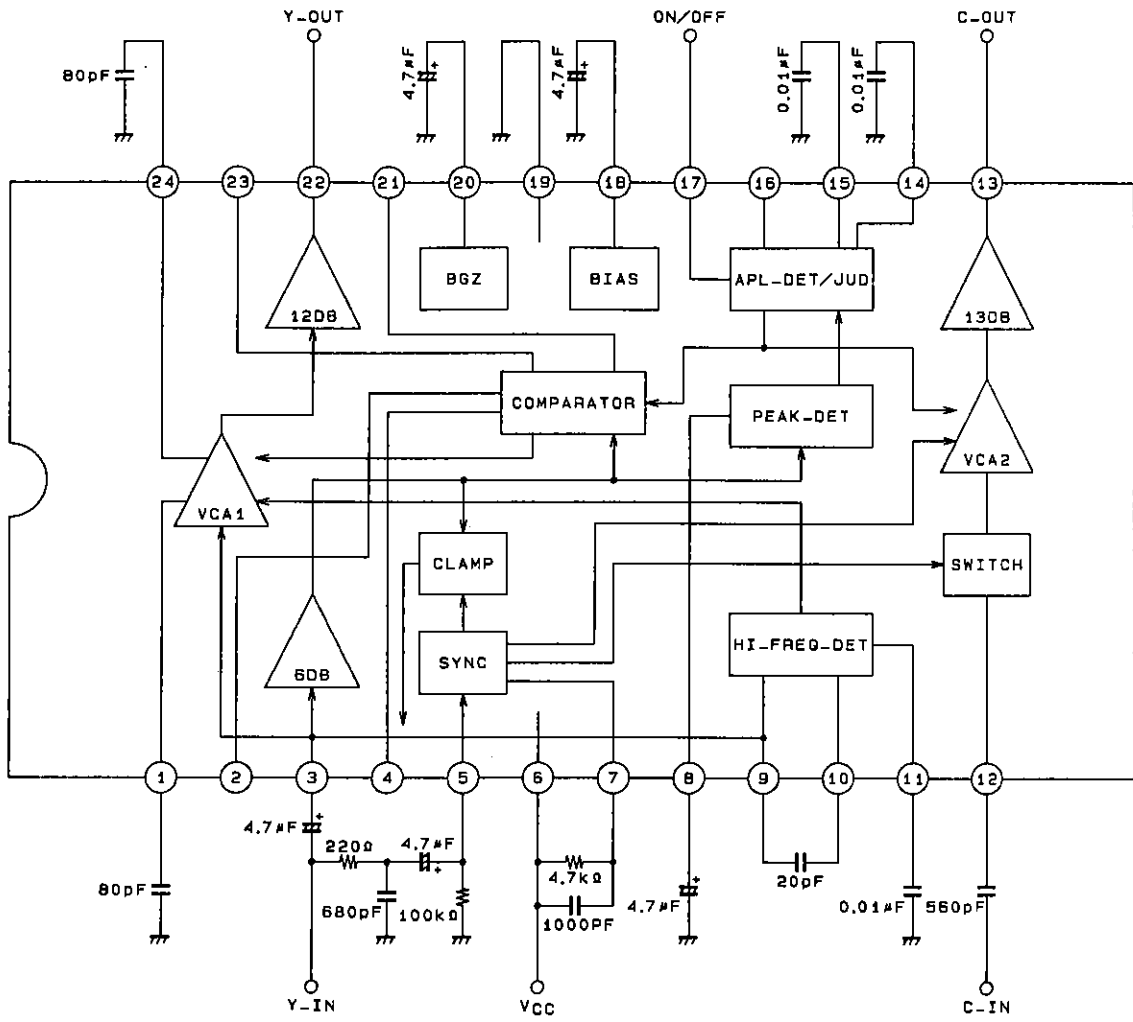

A03801

Pin Descriptions

- Pins 1 and 24

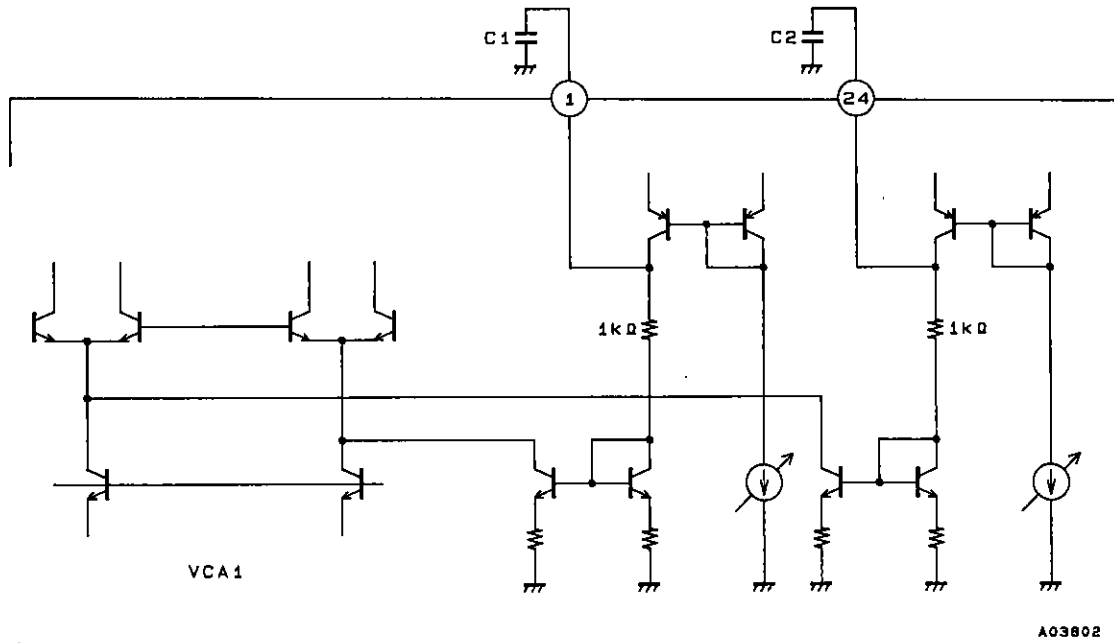

Pins 1 and 24 are frequency control pins for the correction signal. If the capacitors C1 and C2 were not connected to pins 1 and 24, when correction was applied to signals that include noise as shown in the figure below, the noise level would increase. Accordingly, the capacitors C1 and C2 are used to reduce the high frequencies so that high-frequency noise levels are not aggravated. (frequency-adaptive type circuit)

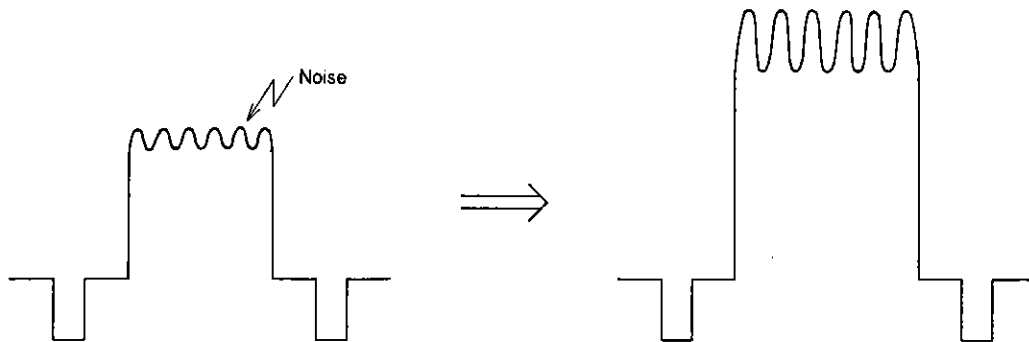

A03803

C1 is provided for when the gain is increased, and C2 for when the gain is decreased. About 2 MHz when C = 82 pF.

LA7668N

- Pins 2, 4, 21 and 23

These are gamma correction reference voltage pins. The gamma characteristics can be changed by changing the voltages applied to these pins from external circuits.

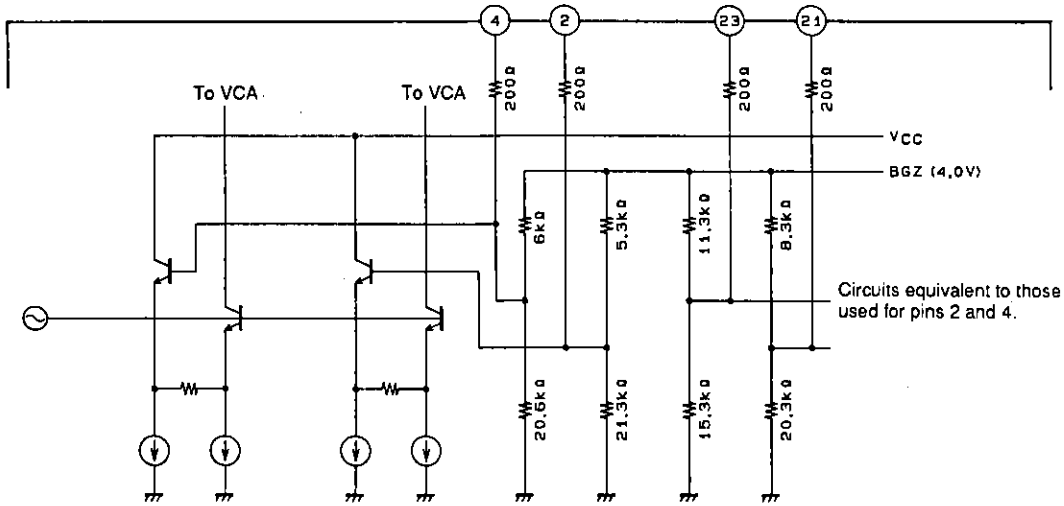

A03804

Pins 2 and 4 are the reference voltages used when APL is high, and pins 21 and 23 are the reference voltages used when APL is low.

The figures below shows the characteristics curves.

• When APL is high

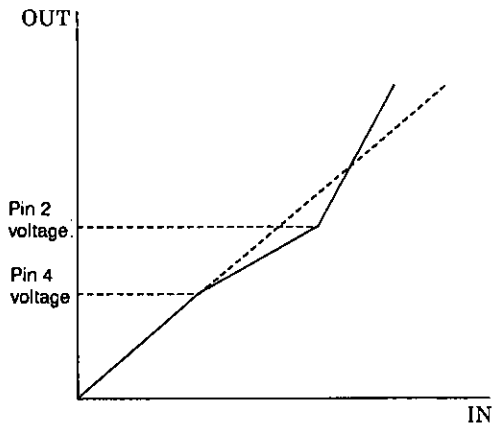

• When APL is low

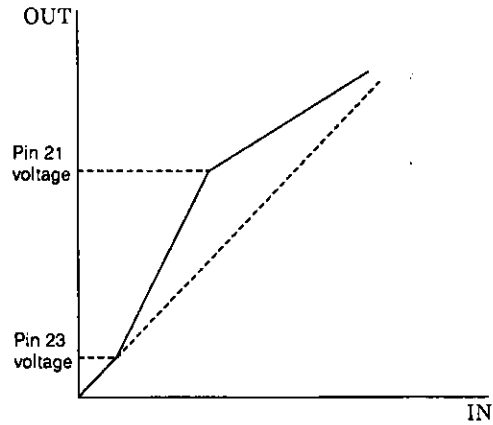

A03805

• Pin 3

Pin 3 is the luminance signal input pin.
The reference input level is 1.0 Vp-p.

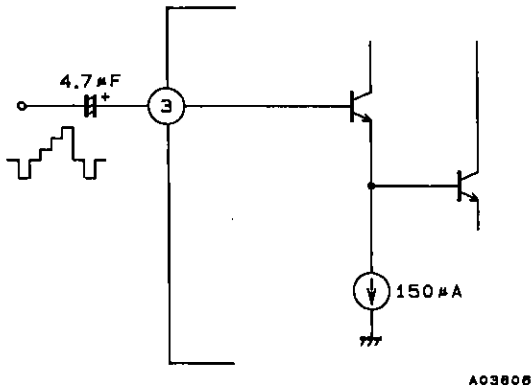

• Pin 5

Pin 5 is the sync separator input pin.

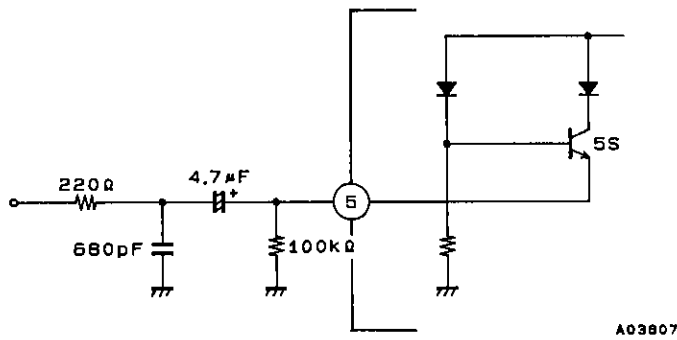

• Pin 6

Pin 6 is the power supply pin. The recommended operating voltage range is 4.5 to 5.5 V. However, operation as low as 4.3 V is possible, although certain device characteristics will be degraded.

• Pin 7

Pin 7 is used to construct the filter that determines the BGP delay time.

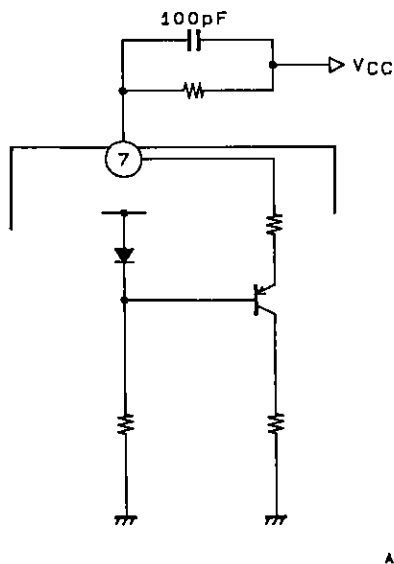

• Pin8

Pin 8 is used to construct the APL level detection filter.

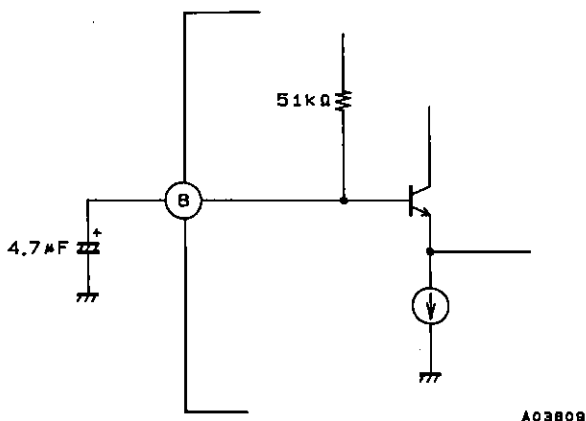

• Pins 9 and 10

Pins 9 and 10 are used for the high-frequency detection circuit high-pass filter capacitor.

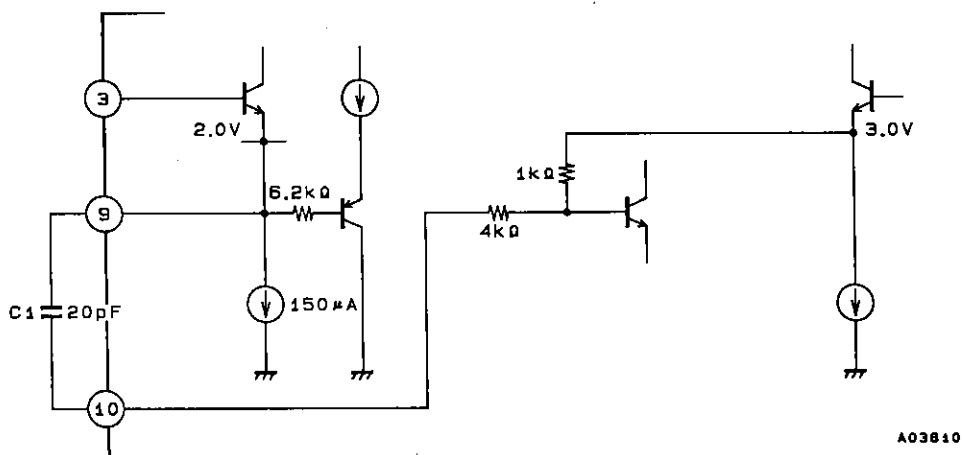

The signal input to pin 3 (the Y input signal) is accepted by an emitter-follower circuit, which outputs a signal clamped to 2.0 V from pin 9. This 2.0 V clamped high-frequency signal is detected by the high-pass filter formed by C1. (A 2 to 3 MHz signal is detected when C1 is 20 pF.)

• Pin 11

Pin 11 is the high-frequency detection circuit control voltage pin.

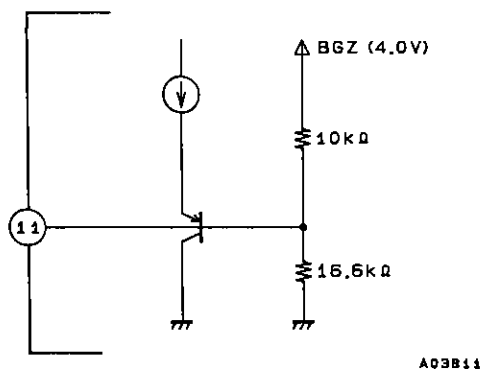

The pin 11 voltage sets the high-frequency detection level. (Pin 11 should normally be set to 2.5 V.) Thus an externally applied voltage can be used to change this detection level.

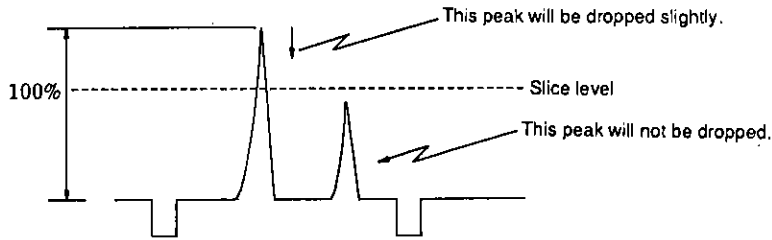

A03812

The capacitor between pins 9 and 10 extracts the high-frequency component for vertical line saturation control. The pin 11 voltage determines the level at which saturation control is not applied. (Note that this circuit only operates when APL is low. The operating level is determined by the pin 16 voltage.)

• Pin 12

Pin 12 is the chrominance signal input pin.

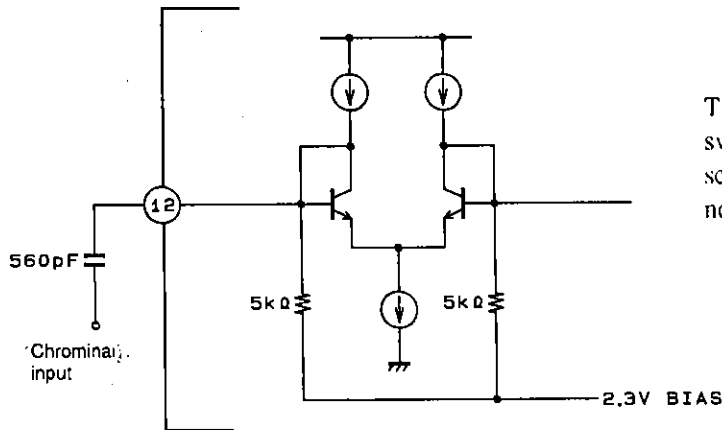

The chrominance signal input circuit is a switching circuit, but could consist of a Y/C separator. This circuit is designed to reduce the noise due to the influence of the SYNC signal.

A03813

• Pin 13

Pin 13 is the chrominance signal output pin.

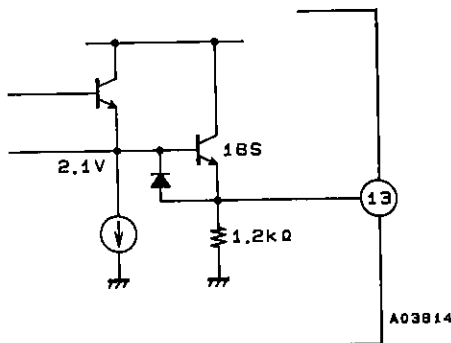

A03814

• Pins 14, 15 and 16

Pins 14, 15 and 16 are the APL level reference voltage pins.

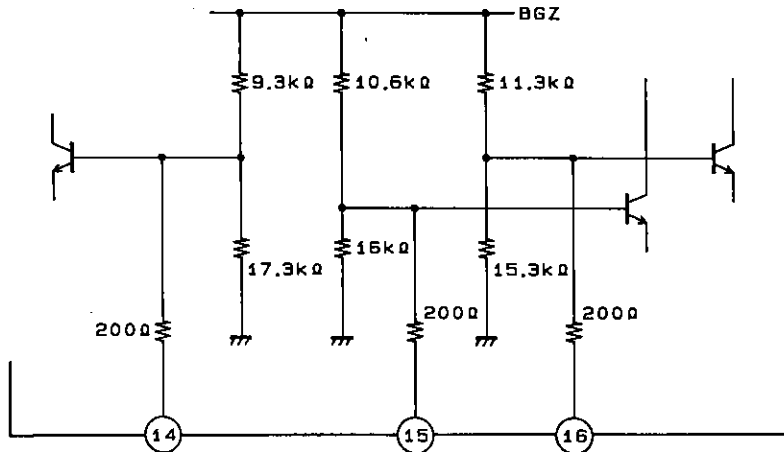

When the APL filter pin (pin 8) voltage is higher than the pin 14 reference voltage (2.6 V), the APL level is judged to be high. If that voltage is lower than the pin 15 reference voltage, the APL level is judged to be low. Pin 16 is a reference voltage for the high-frequency detection circuit, and the vertical line saturation suppression circuit operates when the pin 8 voltage is lower than the pin 16 voltage. See the description of the APL filter voltage characteristics on page 10 for details on the relationship between the APL level and the APL filter pin voltage.

• Pin 17

Pin 17 mutes the correction circuit.

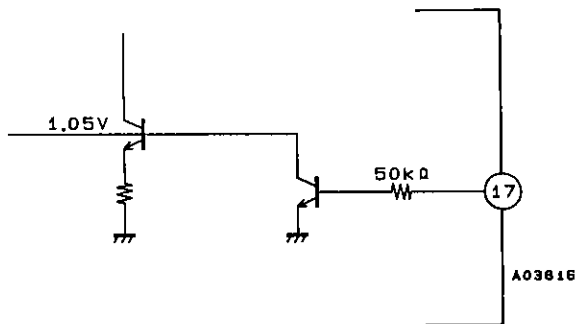

• Pin 18

Pin 18 is the 2.0 V Y signal system reference voltage pin.

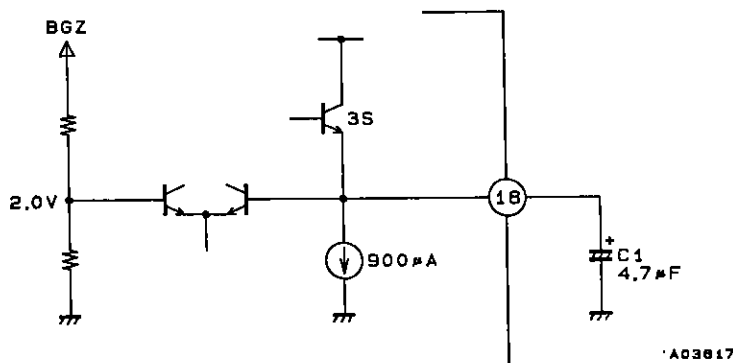

This reference voltage pin determines the Y signal system clamp and output voltages. C1 is used to exclude noise from the reference voltage line.

- Pin 19
Pin 19 is the IC ground pin.

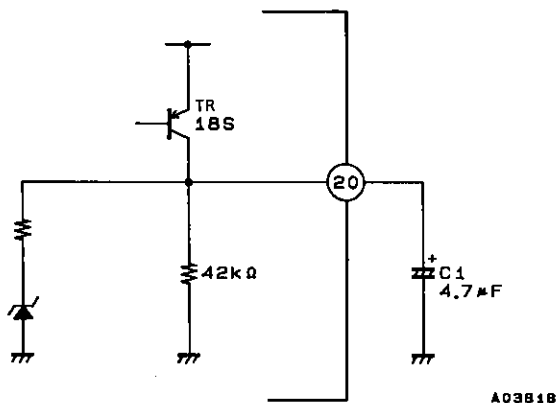

- Pin 20
Pin 20 is the BGZ output voltage pin. C1 is used to exclude noise and prevent oscillation. The pin 20 circuit can supply an output current of up to 4 mA when V_{CC} is 4.5 V. Note that if V_{CC} is under 4.3 V, the pin 20 voltage will become lower due to the influence of the transistor's VCE. (The IC can be operated with V_{CC} as low as 4.3 V if an output current is not taken from this pin.) The figure below shows the output voltage vs. current characteristics, i.e., the BGZ output voltage characteristics.

- Pin 22
Pin 22 is the Y output pin.

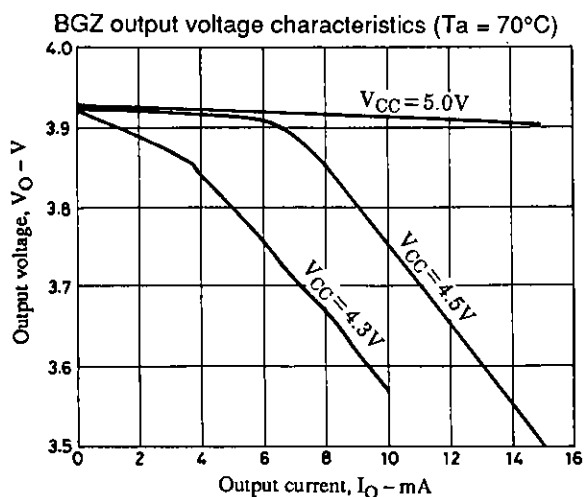
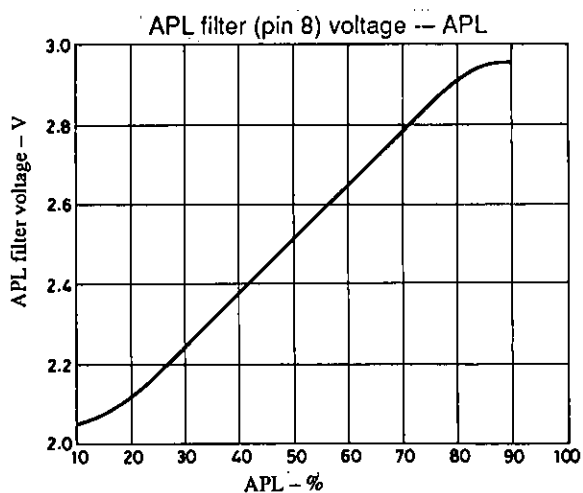
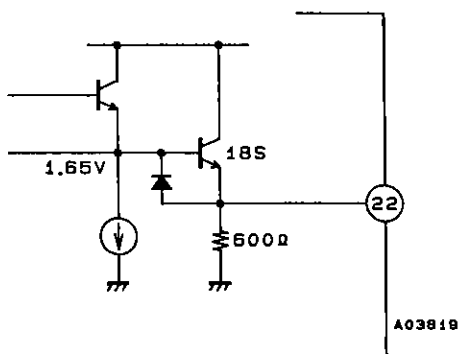

Characteristic Output Waveforms

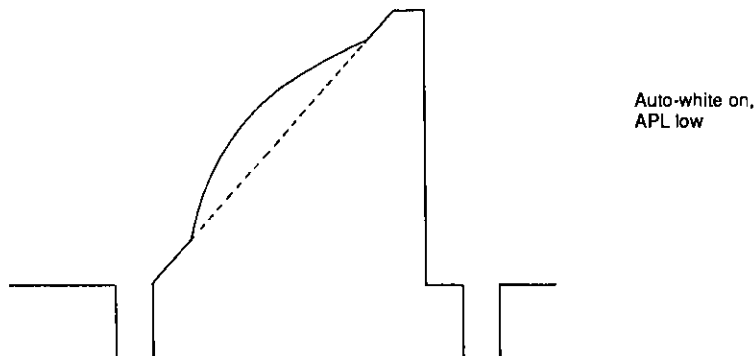
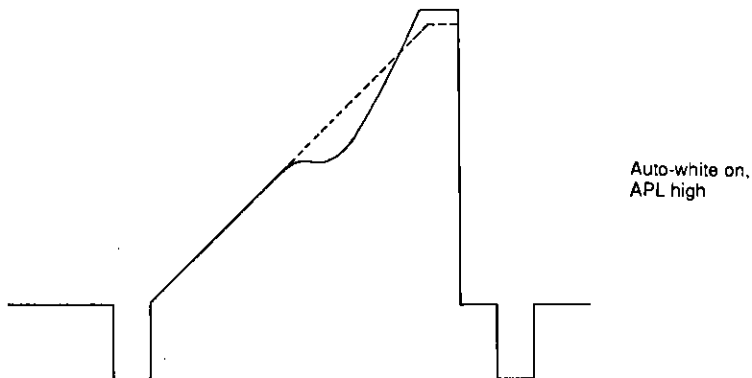
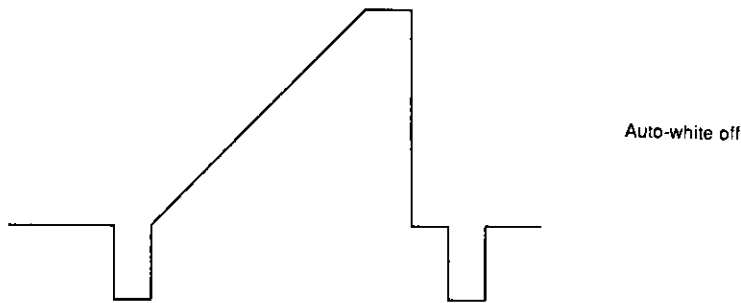

A03020

- No products described or contained herein are intended for use in surgical implants, life-support systems, aerospace equipment, nuclear power control systems, vehicles, disaster/crime-prevention equipment and the like, the failure of which may directly or indirectly cause injury, death or property loss.
- Anyone purchasing any products described or contained herein for an above-mentioned use shall:
 - ① Accept full responsibility and indemnify and defend SANYO ELECTRIC CO., LTD., its affiliates, subsidiaries and distributors and all their officers and employees, jointly and severally, against any and all claims and litigation and all damages, cost and expenses associated with such use:
 - ② Not impose any responsibility for any fault or negligence which may be cited in any such claim or litigation on SANYO ELECTRIC CO., LTD., its affiliates, subsidiaries and distributors or any of their officers and employees jointly or severally.
- Information (including circuit diagrams and circuit parameters) herein is for example only; it is not guaranteed for volume production. SANYO believes information herein is accurate and reliable, but no guarantees are made or implied regarding its use or any infringements of intellectual property rights or other rights of third parties.

This catalog provides information as of June, 1995. Specifications and information herein are subject to change without notice.