

FEATURES

- Low Cost
- 1000VDC Isolation
- Efficiency up to 80%
- Low Ripple and Noise
- MTBF > 1,000,000 Hours
- Remote ON/OFF Control
- Internal SMT Construction
- 4:1 Ultra Wide Input Range
- UL 94V-0 Package Material
- Temperature Performance -40°C to +85°C



SPECIFICATIONS: LANEUW Series

All specifications are based on 25°C, Nominal Input Voltage, and Maximum Output Current unless otherwise noted.
We reserve the right to change specifications based on technological advances.

SPECIFICATION	TEST CONDITIONS	Min	Nom	Max	Unit
INPUT (V_{in})					
Input Voltage Range (24V input models)		9	24	36	VDC
Input Voltage Range (48V input models)		18	48	75	VDC
Start Voltage 24V input models		8	12	18	VDC
Start Voltage (48V input models)		16	24	36	VDC
Under Voltage Shutdown (24V input models)				8	VDC
Under Voltage Shutdown (48V input models)				16	VDC
Reverse Polarity Input Current	All models			0.5	A
Input Surge Voltage (1000ms) (24V input models)		-0.7		50	VDC
Input Surge Voltage (1000ms) (48V input models)		-0.7		100	VDC
Reflected Ripple Current		See Table			
Short Circuit Input Power	All models			1500	mW
Input Filter	All models	Capacitor Type			
OUTPUT (V_o)					
Output Voltage Range		See Table			
Output Voltage Accuracy			±1.0	±2.0	%
Output Voltage Balance	Dual Output, Balanced Loads		±1.0	±2.0	%
Load Regulation	I _o = 25% to 100%		±0.5	±0.75	%
Line Regulation	V _{in} = Min to Max		±0.3	±0.5	%
Output Power				2	W
Output Current Range		See Table			
Ripple & Noise (20MHz)			30	50	mV _{pk-pk}
Ripple & Noise (20MHz)	Over Line, Load, and Temperature			75	mV _{pk-pk}
Ripple & Noise (20MHz)				15	mV _{rms}
Transient Recovery Time	25% Load Step Change		100	300	µs
Transient Response Deviation	25% Load Step Change		±3	±5	%
Temperature Coefficient			±0.01	±0.02	%/°C
REMOTE ON/OFF					
Supply On	Under 0.6VDC or Open Circuit, drops down to 0VDC by 2mV/°C				
Supply Off		2.7		15	VDC
Device Standby Input Current			0.1	0.2	mA
Control Input Current (On)				-1	mA
Control Input Current (Off)				1	mA
Control Common	Referenced to Negative Input				
PROTECTION					
Over Power Protection		120			%
Short Circuit Protection		Continuous			
Input Fuse Recommendation (24V input models)		350mA Slow-Blow Type			
Input Fuse Recommendation (48V input models)		135mA Slow-Blow Type			
GENERAL					
Efficiency		See Table			
Switching Frequency			300		KHz
Isolation Voltage Rated	60 seconds	1000			VDC
Isolation Voltage Test	Flash Tested for 1 second	1100			VDC
Isolation Resistance	500VDC	1000			MΩ
Isolation Capacitance	100KHz, 1V		250	500	pF
Maximum Capacitive Load		See Table			
Internal Power Dissipation				2500	mW

SPECIFICATION	TEST CONDITIONS	Min	Nom	Max	Unit
ENVIRONMENTAL					
Operating Temperature (Ambient)		-40		+85	°C
Operating Temperature (Case)		-40		+90	°C
Storage Temperature		-55		+105	°C
Lead Temperature	1.5mm from case for 10 seconds			260	°C
Humidity				95	%
Cooling		Free air convection			
MTBF	MIL-HDBK-217F @ 25°C, Ground Benign	1,000,000 Hours			
PHYSICAL					
Weight		6.5 grams			
Dimensions		25.95 x 9.25 x 12.45 mm			
Case Material		Non-conductive black plastic			

OUTPUT VOLTAGE / CURRENT RATING CHART

Model Number	Input Voltage	Output Voltage	Output Current		Input Current		Reflected Ripple Current	Efficiency (Typ)	Max Capacitive Load
			Min	Max	No Load	Max Load			
LANEUW2433R	24 VDC (9 – 36 VDC)	3.3 VDC	125 mA	500 mA	20 mA	97 mA	300 mA (Typ)	71%	2200µF
LANEUW2405R		5 VDC	100 mA	400 mA		110 mA		76%	1000µF
LANEUW2412R		12 VDC	42 mA	167 mA		106 mA		79%	170µF
LANEUW2415R		15 VDC	33 mA	134 mA		105 mA		80%	110µF
LANEUW2405RD		±5 VDC	±50 mA	±200 mA		114 mA		73%	470µF
LANEUW2412RD		±12 VDC	±21 mA	±83 mA		108 mA		77%	100µF
LANEUW2415RD		±15 VDC	±17 mA	±67 mA		106 mA		79%	47µF
LANEUW4833R		48 VDC (18 – 75 VDC)	3.3 VDC	125 mA		500 mA		15 mA	49 mA
LANEUW4805R	5 VDC		100 mA	400 mA	58 mA	72%	1000µF		
LANEUW4812R	12 VDC		42 mA	167 mA	54 mA	78%	170µF		
LANEUW4815R	15 VDC		33 mA	134 mA	54 mA	78%	110µF		
LANEUW4805RD	±5 VDC		±50 mA	±200 mA	60 mA	70%	470µF		
LANEUW4812RD	±12 VDC		±21 mA	±83 mA	55 mA	76%	100µF		
LANEUW4815RD	±15 VDC		±17 mA	±67 mA	55 mA	76%	47µF		

NOTES

- Specifications typical at +25°C, resistive load, nominal input voltage, rated output current unless otherwise noted.
- Transient Recovery Time is measured to within 1% error band for a step change in output of 75% to 100%.
- Ripple and noise measured at 20MHz bandwidth.
- The LANEUW Series requires a minimum load on the output to maintain specified regulation. Operation under no-load conditions will not damage these devices, however they may not meet all listed specifications.
- All DC/DC converters should be externally fused on the front end for protection.
- Other input and output voltages may be available, please contact factory.
- Specifications subject to change without notice.

BLOCK DIAGRAMS

Single Output

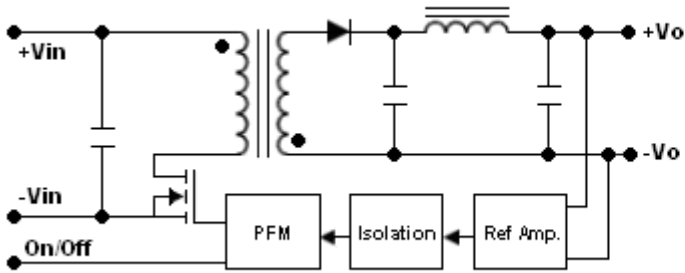

Dual Output

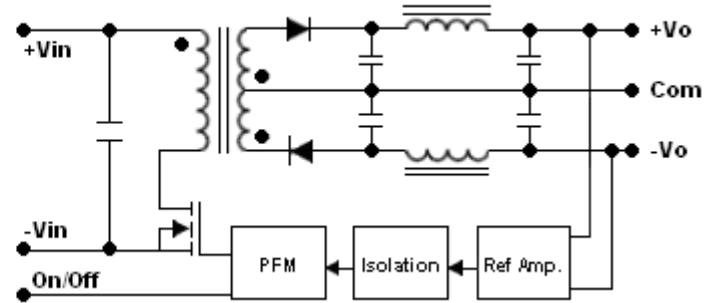

Input Voltage Transient Rating

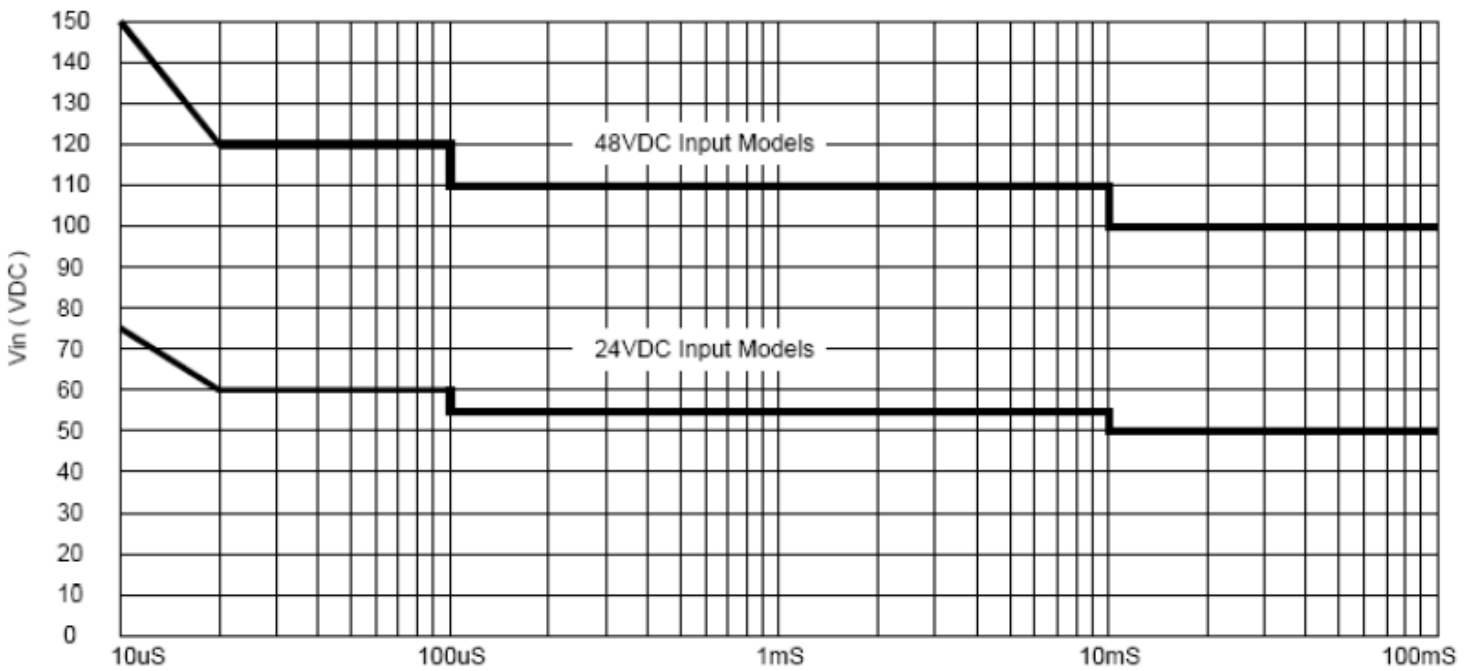

MECHANICAL DRAWING

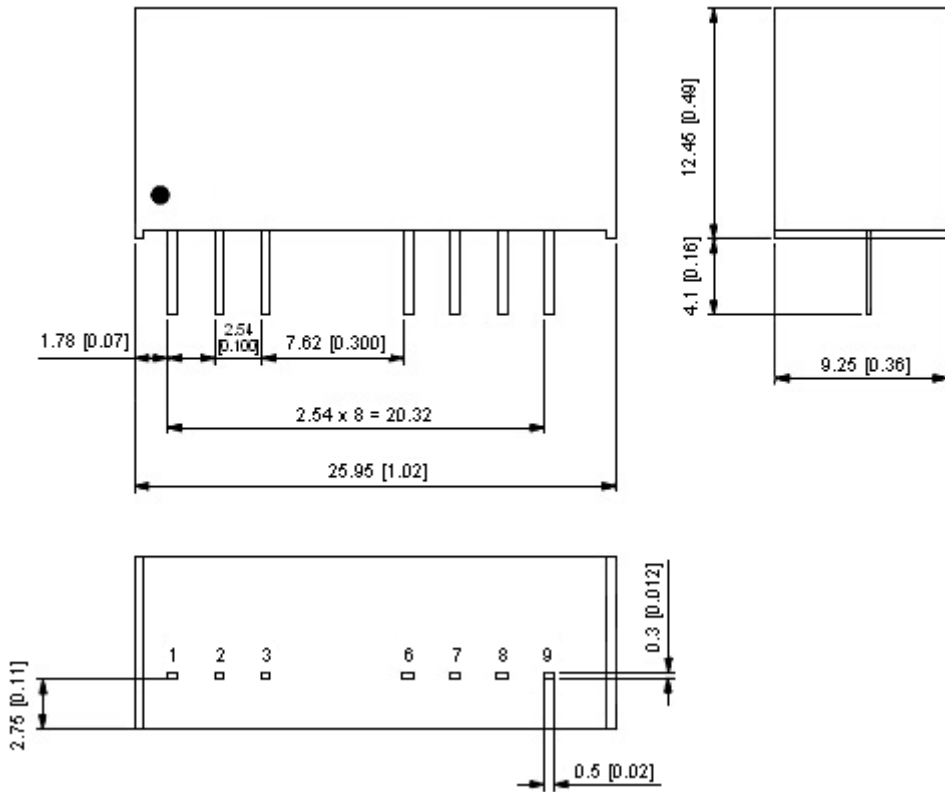

Connecting Pin Patterns
 Top View (2.54mm / 0.1 inch grids)

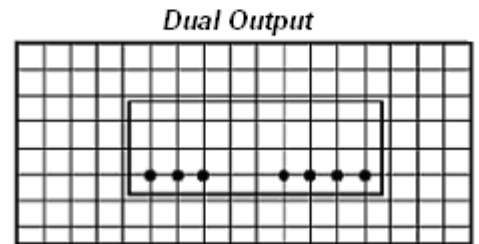
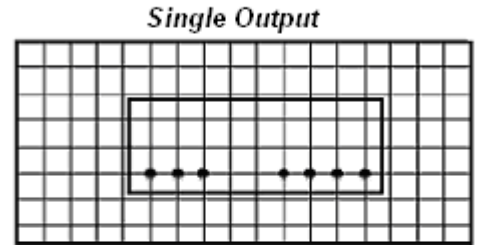

Tolerance:	Millimeters	Inches
	X.X±0.25	X.XX±0.01
	X.XX±0.13	X.XXX±0.005
Pin:	±0.05	±0.002

PIN CONNECTIONS		
Pin	Single Output	Dual Output
1	-Vin	-Vin
2	+Vin	+Vin
3	Remote On/Off	Remote On/Off
6	+Vout	+Vout
7	NC	Common
8	NC	NC
9	-Vout	-Vout

DESIGN & FEATURE CONSIDERATIONS

Input Source Impedance

The power module should be connected to a low ac-impedance input source. Highly inductive source impedances can affect the stability of the power module.

In applications where power is supplied over long lines and output loading is high, it may be necessary to use a capacitor at the input to ensure startup.

Capacitor mounted close to the power module helps ensure stability of the unit, it is recommended to use a good quality low Equivalent Series Resistance (ESR < 1.0Ω at 100 KHz) capacitor of a 1.5uF for the 24V and 48V input devices.

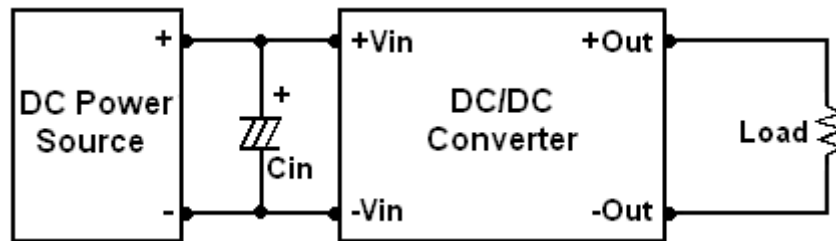

Maximum Capacitive Load

The LANEUW Series has a limitation of maximum connected capacitance on the output. The power module may be operated in current limiting mode during start-up, affecting the ramp-up and the startup time. The maximum capacitance can be found in the “Output Voltage / Current Rating Chart.”

Over Current Protection

To provide protection in a fault (output overload) condition, the unit is equipped with internal current limiting circuitry and can endure current limiting for an unlimited duration. At the point of current-limit inception, the unit shifts from voltage control to current control. The unit operates normally once the output current is brought back into its specified range.

Efficiency vs Input Voltage (Single Output)

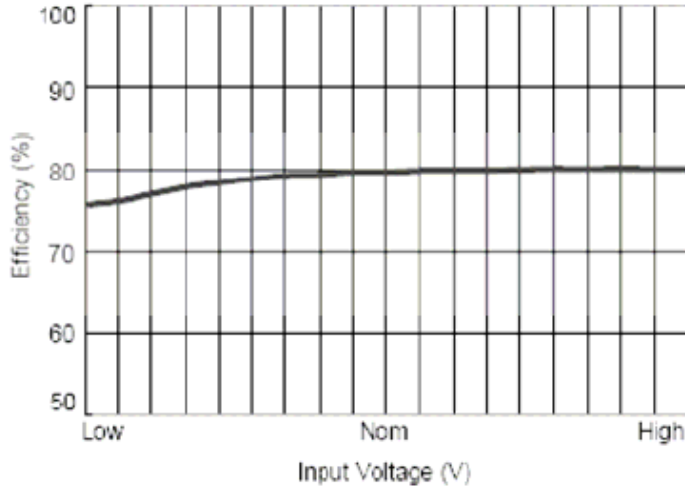

Efficiency vs Input Voltage (Dual Output)

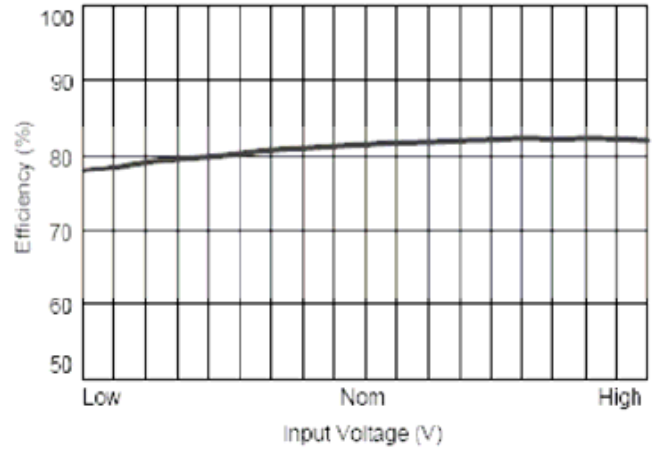

Efficiency vs Output Load (Single Output)

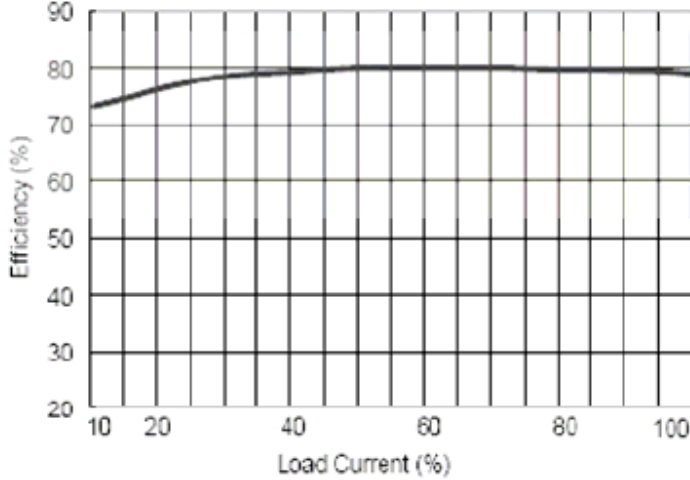

Efficiency vs Output Load (Dual Output)

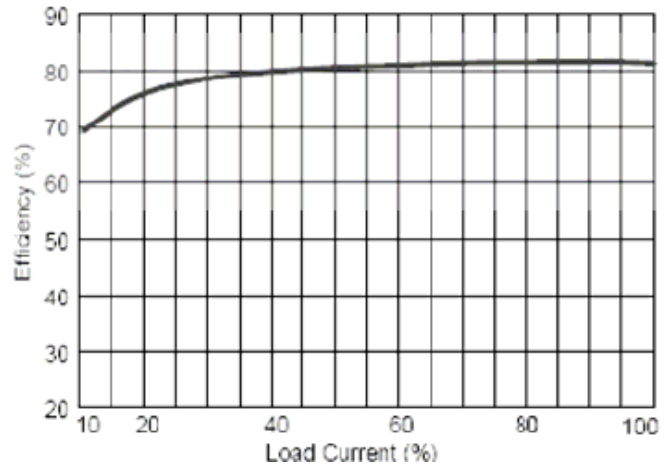

Derating Curve

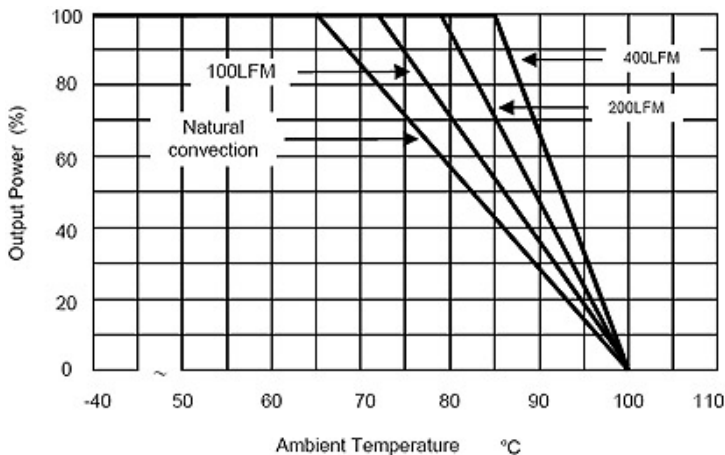

TEST CONFIGURATIONS

Input Reflected-Ripple Current Test Setup

Input reflected-ripple current is measured with an inductor L_{in} (4.7uH) and C_{in} (220uF, ESR < 1.0Ω at 100 KHz) to simulate source impedance.

Capacitor C_{in} offsets possible battery impedance.

Current ripple is measured at the input terminals of the module. Measurement bandwidth is 0-500 KHz.

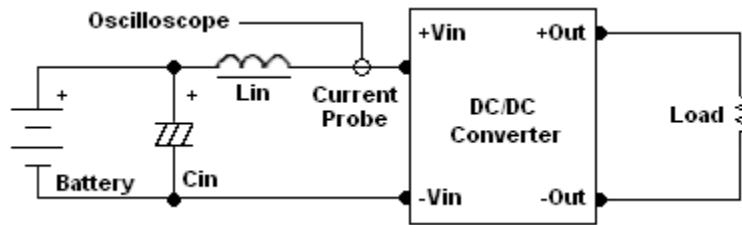

Peak-to-Peak Output Noise Measurement Test

Use a C_{out} 0.47uF ceramic capacitor.

Scope measurement should be made by using a BNC socket, measurement bandwidth is 0-20MHz.

Position the load between 50mm and 75mm from the DC/DC Converter.

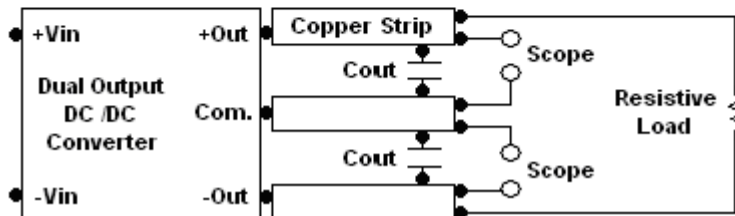
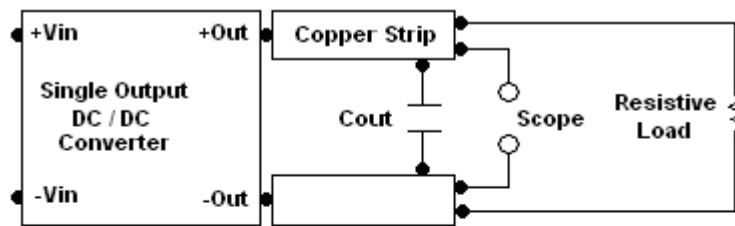

Output Ripple Reduction

A good quality low ESR capacitor placed as close as possible across the load will give the best ripple and noise performance. To reduce output ripple, it is recommended to use 3.3uF capacitors at the output.

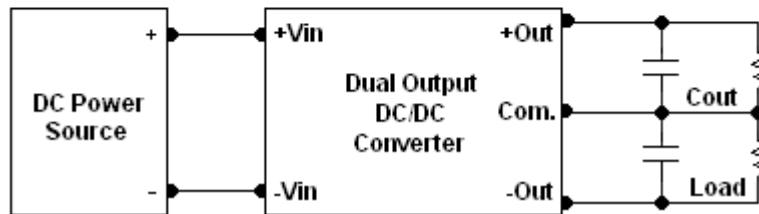
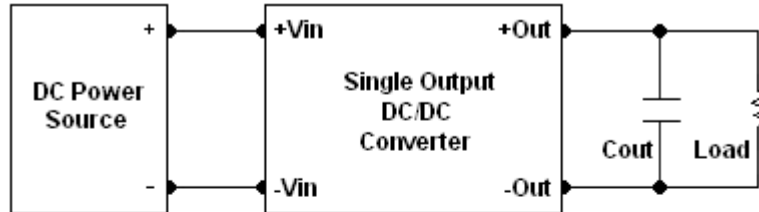

Thermal Considerations

Many conditions affect the thermal performance of the power module, such as orientation, airflow over the module, and board spacing. To avoid exceeding the maximum temperature rating of the components inside the power module, the case temperature must be kept below 90°C. The derating curves are determined from measurements obtained in an experimental apparatus.

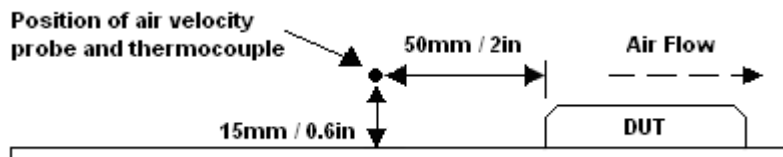



Wall Industries, Inc.

LANEUW Series
Single and Dual Output
2 Watt DC/DC Converter
4:1 Ultra Wide Input Range

COMPANY INFORMATION:

Wall Industries, Inc. has created custom and modified units for over 40 years. Our in-house research and development engineers will provide a solution that exceeds your performance requirements on time and on budget. Our ISO9001-2000 certification is just one example of our commitment to producing a high quality, well documented product for our customers.

Our past projects demonstrate our commitment to you, our customer. Wall Industries, Inc. has a reputation for working closely with its customers to ensure each solution meets or exceeds form, fit and function requirements. We will continue to provide ongoing support for your project above and beyond the design and production phases. Give us a call today to discuss your future projects.

Contact **Wall Industries** for further information:

<u>Phone:</u>	☎(603)778-2300
<u>Toll Free:</u>	☎(888)587-9255
<u>Fax:</u>	☎(603)778-9797
<u>E-mail:</u>	sales@wallindustries.com
<u>Web:</u>	www.wallindustries.com
<u>Address:</u>	5 Watson Brook Rd. Exeter, NH 03833