

Silicon Switching Diode

FEATURE

- We declare that the material of product compliance with RoHS requirements.
- S- Prefix for Automotive and Other Applications Requiring Unique Site and Control Change Requirements; AEC-Q101 Qualified and PPAP Capable.

LBAS16TT1G
S-LBAS16TT1G

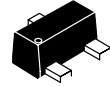

SC-89

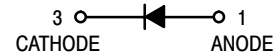

MAXIMUM RATINGS (T_A = 25°C)

Rating	Symbol	Max	Unit
Continuous Reverse Voltage	V _R	75	V
Recurrent Peak Forward Current	I _R	200	mA
Peak Forward Surge Current Pulse Width = 10 μs	I _{FM(surge)}	500	mA
Total Power Dissipation, One Diode Loaded T _A = 25°C Derate above 25°C Mounted on a Ceramic Substrate (10 x 8 x 0.6 mm)	P _D	150 1.6	mW mW/°C
Operating and Storage Junction Temperature Range	T _J , T _{stg}	-55 to +150	°C

THERMAL CHARACTERISTICS

Characteristic	Symbol	Max	Unit
Thermal Resistance, Junction to Ambient One Diode Loaded Mounted on a Ceramic Substrate (10 x 8 x 0.6 mm)	R _{θJA}	0.625	°C/mW

DEVICE MARKING

LBAS16TT1G= A6

ELECTRICAL CHARACTERISTICS (T_A = 25°C unless otherwise noted)

Characteristic	Symbol	Min	Max	Unit
Forward Voltage (I _F = 1.0 mA) (I _F = 10 mA) (I _F = 50 mA) (I _F = 150 mA)	V _F	— — — —	715 866 1000 1250	mV
Reverse Current (V _R = 75 V) (V _R = 75 V, T _J = 150°C) (V _R = 25 V, T _J = 150°C)	I _R	— — —	1.0 50 30	μA
Capacitance (V _R = 0, f = 1.0 MHz)	C _D	—	2.0	pF
Reverse Recovery Time (I _F = I _R = 10 mA, R _L = 50 Ω) (Figure 1)	t _{rr}	—	6.0	ns
Stored Charge (I _F = 10 mA to V _R = 6.0 V, R _L = 500 Ω) (Figure 2)	Q _S	—	45	PC
Forward Recovery Voltage (I _F = 10 mA, t _r = 20 ns) (Figure 3)	V _{FR}	—	1.75	V

ORDERING INFORMATION

Device	Marking	Shipping
LBAS16TT1G S-LBAS16TT1G	A6	3000/Tape&Reel
LBAS16TT3G S-LBAS16TT3G	A6	10000/Tape&Reel

LBAS16TT1G, S-LBAS16TT1G

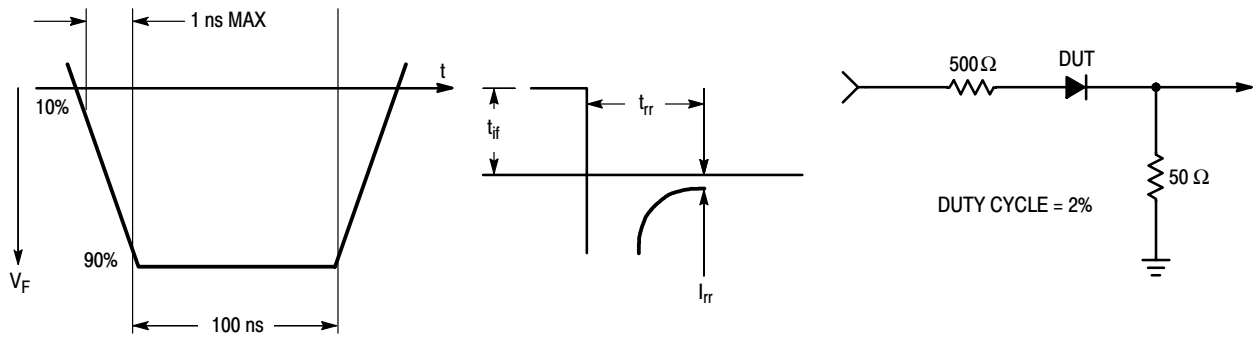

Figure 1. Reverse Recovery Time Equivalent Test Circuit

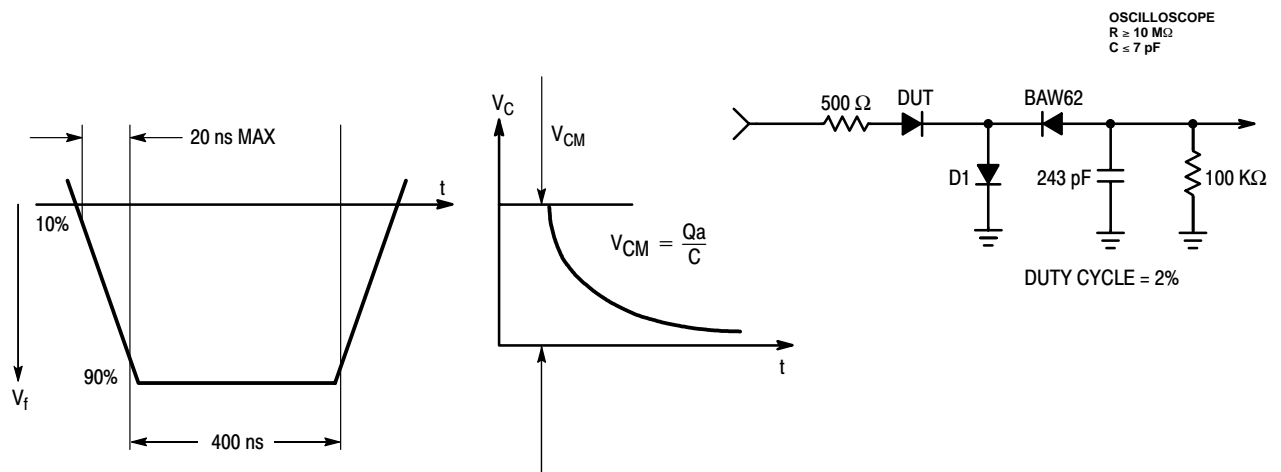

Figure 2. Recovery Charge Equivalent Test Circuit

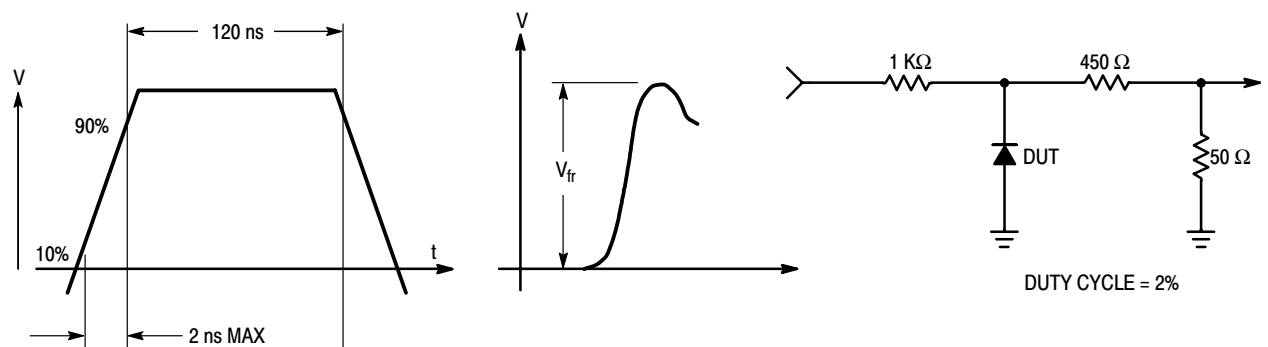

Figure 3. Forward Recovery Voltage Equivalent Test Circuit

LBAS16TT1G, S-LBAS16TT1G

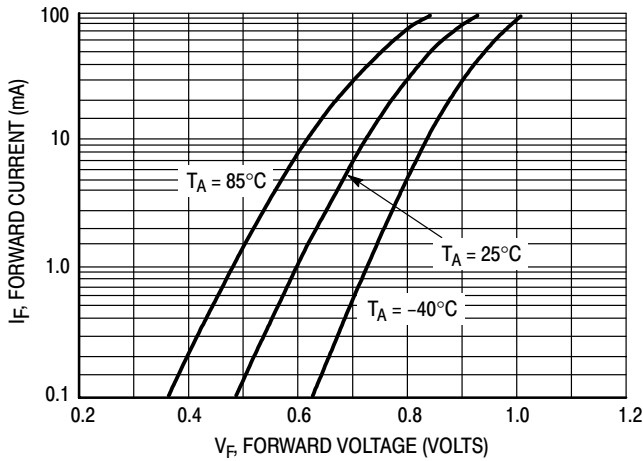

Figure 4. Forward Voltage

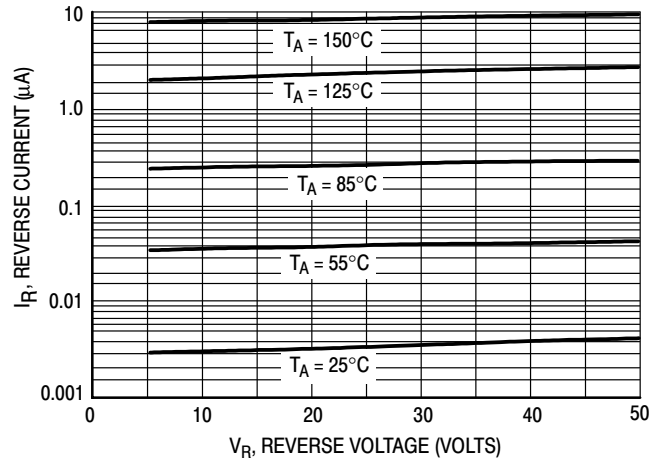

Figure 5. Leakage Current

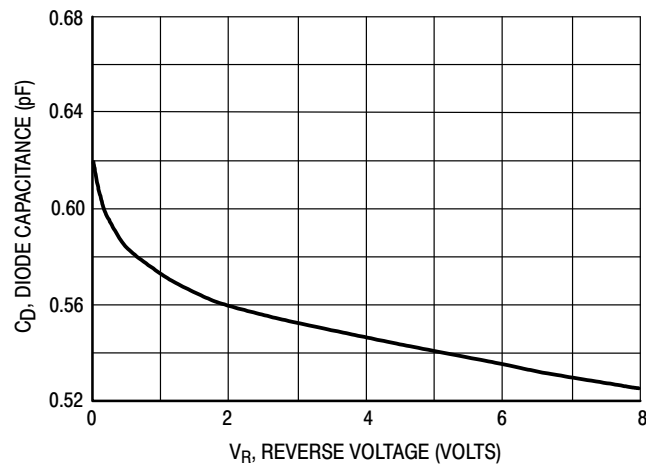
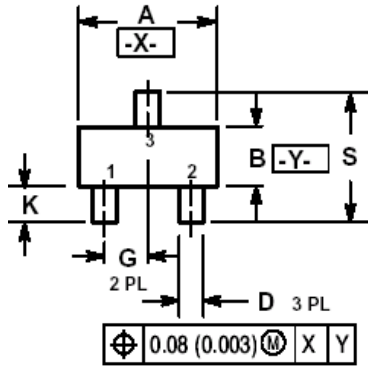

Figure 6. Capacitance

LBAS16TT1G, S-LBAS16TT1G

SC-89



NOTES:

- 1.DIMENSIONING AND TOLERANCING PER ANSI Y14.5M, 1982.
- 2.CONTROLLING DIMENSION: MILLIMETERS
- 3.MAXIMUM LEAD THICKNESS INCLUDES LEAD FINISH THICKNESS. MINIMUM LEAD THICKNESS IS THE MINIMUM THICKNESS OF BASE MATERIAL.
- 4.463C-01 OBSOLETE, NEW STANDARD 463C-02.

DIM	MILLIMETERS			INCHES		
	MIN	NOM	MAX	MIN	NOM	MAX
A	1.50	1.60	1.70	0.059	0.063	0.067
B	0.75	0.85	0.95	0.030	0.034	0.040
C	0.60	0.70	0.80	0.024	0.028	0.031
D	0.23	0.28	0.33	0.009	0.011	0.013
G	0.50 BSC			0.020 BSC		
H	0.53 REF			0.021 REF		
J	0.10	0.15	0.20	0.004	0.006	0.008
K	0.30	0.40	0.50	0.012	0.016	0.020
L	1.10 REF			0.043 REF		
M	---	---	10 °	---	---	10 °
N	---	---	10 °	---	---	10 °
S	1.50	1.60	1.70	0.059	0.063	0.067

