

Lumineszenzdioden

Light Emitting Diodes

SMT-LED

SMT-LEDs

Package	Type	Emissionsfarbe Emission color	λ_{dom} (typ.) [nm]	Farbe der Licht- austrittsfläche Color of light emitting area				2 ϕ (typ.) (50% I _V) [deg.]	Bestellnummer Ordering code	Fig.
					I _V [mcd]	Φ_V [mlm]	at I _F [mA]			

TOPLED®

TOPLED®

	LH T674-KM LH T674-L LH T674-M LH T674-LN	hyper-red	645	colorless clear	6.3 ... 32 10 ... 20 16 ... 32 10 ... 50	– 45 (typ.) 75 (typ.) –	10 10 10 10	120	Q62703-Q2329 Q62703-Q2282 Q62703-Q2288 Q62703-Q2617	1
	LS T670-HK LS T670-J LS T670-K LS T670-L LS T670-JM	super-red	628	colorless clear	2.5 ... 12.5 4 ... 8 6.3 ... 12.5 10 ... 20 4 ... 32	– 18 (typ.) 30 (typ.) 45 (typ.) –	10 10 10 10 10	120	Q62703-Q2309 Q62703-Q2357 Q62703-Q2358 Q62703-Q3848 Q62703-Q3849	
	LO T670-HK LO T670-J LO T670-K LO T670-L LO T670-JM	orange	605	colorless clear	2.5 ... 12.5 4 ... 8 6.3 ... 12.5 10 ... 20 4 ... 32	– 18 (typ.) 30 (typ.) 45 (typ.) –	10 10 10 10 10	120	Q62703-Q2310 Q62703-Q2475 Q62703-Q2476 Q62703-Q3850 Q62703-Q3851	
	LY T670-HK LY T670-J LY T670-K LY T670-L LY T670-JM	yellow	590	colorless clear	2.5 ... 12.5 4 ... 8 6.3 ... 12.5 10 ... 20 4 ... 32	– 18 (typ.) 30 (typ.) 45 (typ.) –	10 10 10 10 10	120	Q62703-Q2311 Q62703-Q2376 Q62703-Q2375 Q62703-Q3098 Q62703-Q3852	
	LG T670-HK LG T670-K LG T670-L LG T670-JM	green	570	colorless clear	2.5 ... 2 6.3 ... 12.5 10 ... 20 4 ... 32	– 30 (typ.) 45 (typ.) –	10 10 10 10	120	Q62703-Q2312 Q62703-Q2378 Q62703-Q3146 Q62703-Q3853	
	LP T670-FJ LP T670-G LP T670-H LP T670-J LP T670-GK	pure green	560	colorless clear	1 ... 2 1.6 ... 3.2 2.5 ... 5 4 ... 8 1.6 ... 12.5	– 8 (typ.) 12 (typ.) 18 (typ.) –	10 10 10 10 10	120	Q62703-Q2619 Q62703-Q3102 Q62703-Q2555 Q62703-Q2653 Q62703-Q2456	
	LG T671-KM LG T671-L LG T671-M LG T671-LN	green	570	colorless clear	6.3 ... 32 10 ... 20 16 ... 32 10 ... 50	– 45 (typ.) 75 (typ.) –	10 10 10 10	120	Q62703-Q3513 Q62703-Q3879 Q62703-Q3880 Q62703-Q3515	

Super TOPLED®

Super TOPLED®

	LS T672-LP LS T672-N LS T672-P LS T672-NR	super-red	628	colorless clear	10 ... 80 25 ... 50 40 ... 80 25 ... 200	– 100 (typ.) 180 (typ.) –	50 50 50 50	120	Q62703-Q2621 Q62703-Q2513 Q62703-Q2514 Q62703-Q2331	1
	LO T672-MQ LO T672-N LO T672-P LO T672-NR	orange	605	colorless clear	16 ... 125 25 ... 50 40 ... 80 25 ... 200	– 100 (typ.) 180 (typ.) –	50 50 50 50	120	Q62703-Q2623 Q62703-Q2494 Q62703-Q2493 Q62703-Q2330	
	LY T672-LP LY T672-N LY T672-P LY T672-NR	yellow	590	colorless clear	10 ... 80 25 ... 50 40 ... 80 25 ... 200	– 100 (typ.) 180 (typ.) –	50 50 50 50	120	Q62703-Q2624 Q62703-Q2515 Q62703-Q2516 Q62703-Q2332	
	LG T672-MQ LG T672-N LG T672-P LG T672-Q LG T672-NR	green	570	colorless clear	16 ... 125 25 ... 50 40 ... 80 63 ... 125 25 ... 200	– 100 (typ.) 180 (typ.) 300 (typ.) –	50 50 50 50 50	120	Q62703-Q2333 Q62703-Q2517 Q62703-Q2518 Q62703-Q3081 Q62703-Q3854	
	LP T672-KN LP T672-L LP T672-M LP T672-N LP T672-LP	pure green	560	colorless clear	6.3 ... 50 10 ... 20 16 ... 32 25 ... 50 10 ... 80	– 45 (typ.) 75 (typ.) 100 (typ.) –	50 50 50 50 50	120	Q62703-Q2626 Q62703-Q2627 Q62703-Q2289 Q62703-Q2290 Q62703-Q2334	

■ Nicht für Neuentwicklungen/Not for new design

Lumineszenzdioden

Light Emitting Diodes

SMT-LED

SMT-LEDs

Package	Type	Emissionsfarbe Emission color	λ_{dom} (typ.) [nm]	Farbe der Licht- austrittsfläche Color of light emitting area				2 ϕ (typ.) (50% I _V) [deg].	Bestellnummer Ordering code	Fig.
					I _V [mcd]	Φ_V [mlm]	at I _F [mA]			

TOPLED® RG (Reverse Gullwing)

TOPLED® RG (Reverse Gullwing)

	LH T774-KM LH T774-L LH T774-M LH T774-LN	hyper-red	645	colorless clear	6.3 ... 32 10 ... 20 16 ... 32 10 ... 50	– 45 (typ.) 75 (typ.) –	10 10 10 10	120	Q62703-Q2725 Q62703-Q2790 Q62703-Q2791 Q62703-Q2792	13
	LS T770-HK LS T770-J LS T770-K LS T770-JL	super-red	628	colorless clear	2.5 ... 12.5 4 ... 8 6.3 ... 12.5 4 ... 20	– 18 (typ.) 30 (typ.) –	10 10 10 10	120	Q62703-Q2726 Q62703-Q2727 Q62703-Q2728 Q62703-Q2729	
	LO T770-HK LO T770-J LO T770-K LO T770-JL	orange	605	colorless clear	2.5 ... 12.5 4 ... 8 6.3 ... 12.5 4 ... 20	– 18 (typ.) 30 (typ.) –	10 10 10 10	120	Q62703-Q2730 Q62703-Q2731 Q62703-Q2732 Q62703-Q2733	
	LY T770-HL LY T770-J LY T770-K LY T770-L LY T770-JM	yellow	690	colorless clear	2.5 ... 20 4 ... 8 6.3 ... 12.5 10 ... 20 4 ... 32	– 18 (typ.) 30 (typ.) 45 (typ.) –	10 10 10 10 10	120	Q62703-Q2734 Q62703-Q2736 Q62703-Q3241 Q62703-Q3906 Q62703-Q2737	
	LG T770-HL LG T770-J LG T770-K LG T770-L LG T770-JM	green	570	colorless clear	2.5 ... 20 4 ... 8 6.3 ... 12.5 10 ... 20 4 ... 32	– 18 (typ.) 30 (typ.) 45 (typ.) –	10 10 10 10 10	120	Q62703-Q2738 Q62703-Q2739 Q62703-Q2740 Q62703-Q3100 Q62703-Q2741	
	LP T770-FJ LP T770-G LP T770-H LP T770-GK	pure green	560	colorless clear	1 ... 8 1.6 ... 3.2 2.5 ... 5 1.6 ... 12.5	– 8 (typ.) 12 (typ.) –	10 10 10 10	120	Q62703-Q2742 Q62703-Q2743 Q62703-Q2744 Q62703-Q2745	

Hyper TOPLED®

Hyper TOPLED®

	LH T676-NR LH T676-P LH T676-Q LH T676-R LH T676-PS	hyper-red	645	colorless clear	25 ... 200 40 ... 80 63 ... 125 100 ... 200 40 ... 320	– 180 (typ.) 300 (typ.) 450 (typ.) –	20 20 20 20 20	120	Q62703-Q3140 Q62703-Q3164 Q62703-Q3141 Q62703-Q3142 Q62703-Q3143	1
	LS T676-NR LS T676-P LS T676-Q LS T676-R LS T676-PS	super-red	632	colorless clear	25 ... 200 40 ... 80 63 ... 125 100 ... 200 40 ... 320	– 180 (typ.) 300 (typ.) 450 (typ.) –	20 20 20 20 20	120	Q62703-Q3135 Q62703-Q3136 Q62703-Q3137 Q62703-Q3138 Q62703-Q3139	
	LA T676-PS LA T676-Q LA T676-R LA T676-S LA T676-QT	amber	615	colorless clear	40 ... 320 63 ... 125 100 ... 200 160 ... 320 63 ... 500	– 300 (typ.) 450 (typ.) 700 (typ.) –	20 20 20 20 20	120	Q62703-Q3423 Q62703-Q3424 Q62703-Q3425 Q62703-Q3426 Q62703-Q3427	
	LO T676-PS LO T676-Q LO T676-R LO T676-S LO T676-QT	orange	605	colorless clear	40 ... 320 63 ... 125 100 ... 200 160 ... 320 63 ... 500	– 300 (typ.) 450 (typ.) 600 (typ.) –	20 20 20 20 20	120	Q62703-Q3066 Q62703-Q3064 Q62703-Q3065 Q62703-Q3091 Q62703-Q3125	
	LY T676-PS LY T676-Q LY T676-R LY T676-S LY T676-QT	yellow	587	colorless clear	40 ... 320 63 ... 125 100 ... 200 160 ... 320 63 ... 500	– 300 (typ.) 450 (typ.) 700 (typ.) –	20 20 20 20 20	120	Q62703-Q3855 Q62703-Q3159 Q62703-Q3160 Q62703-Q3404 Q62703-Q3161	
	BLUE LINE™ LB T676 LB T676-J1 LB T676-J2 LB T676-K1 LB T676-K2 LB T676-L1	blue	466	colorless clear	4.0 ... 6.3 5.0 ... 8.0 6.3 ... 10.0 8.0 ... 12.5 10.0 ... 16.0	15 (typ.) 20 (typ.) 25 (typ.) 30 (typ.) 40 (typ.)	10 10 10 10 10	120	Q62703-Q3786	

Lumineszenzdiode

Light Emitting Diodes

SMT-LED

SMT-LEDs

Package	Type	Emissionsfarbe Emission color	λ_{dom} (typ.) [nm]	Farbe der Licht- austrittsfläche Color of light emitting area				2 ϕ (typ.) (50% I _V) [deg].	Bestellnummer Ordering code	Fig.
					I _V [mcd]	Φ_V [mlm]	at I _F [mA]			

Hyper TOPLED® (Forts.)

Hyper TOPLED® (cont'd)

	LW T676 LW T676-L2 LW T676-M1 LW T676-M2 LW T676-N1	white	x=0.30 y=0.32	colored diffused	12.5 ... 20.0 16.0 ... 25.0 20.0 ... 32.0 25.0 ... 40.0	50 (typ.) 60 (typ.) 80 (typ.) 100 (typ.)	10 10 10 10	120	Q62703-Q4450	1
---	--	-------	------------------	---------------------	--	---	----------------------	------------	--------------	---

Power TOPLED®

Power TOPLED®

	LA E675 LA E675-T1 LA E675-T2 LA E675-U1 LA E675-U2	amber	617	colorless clear	250 ... 400 320 ... 500 400 ... 630 500 ... 800	900 (typ.) 1200 (typ.) 1500 (typ.) 1800 (typ.)	50	120	Q62703-Q3764	33
	LY E676 LY E676-T1 LY E676-T2 LY E676-U1 LY E676-U2	yellow	590	colorless clear	250 ... 400 320 ... 500 400 ... 630 500 ... 800	900 (typ.) 1200 (typ.) 1500 (typ.) 1800 (typ.)	50	120	Q62703-Q3759	

Hyper TOPLED® RG (Reverse Gullwing)

Hyper TOPLED® RG (Reverse Gullwing)

	LS T776-NR LS T776-P LS T776-Q LS T776-R LS T776-PS	super-red	632	colorless clear	25 ... 200 40 ... 80 63 ... 125 100 ... 200 40 ... 320	– 180 (typ.) 300 (typ.) 450 (typ.) –	20 20 20 20 20	120	Q62703-Q3270 Q62703-Q3271 Q62703-Q3272 Q62703-Q3273 Q62703-Q3274	13
	LA T776-PS LA T776-Q LA T776-R LA T776-S LA T776-QT	amber	615	colorless clear	40 ... 320 63 ... 125 100 ... 200 160 ... 320 63 ... 500	– 300 (typ.) 450 (typ.) 700 (typ.) –	20 20 20 20 20	120	Q62703-Q3914 Q62703-Q3915 Q62703-Q3916 Q62703-Q3917 Q62703-Q3918	
	LO T776-PS LO T776-Q LO T776-R LO T776-S LO T776-QT	orange	645	colorless clear	40 ... 320 63 ... 125 100 ... 200 160 ... 320 63 ... 500	– 300 (typ.) 450 (typ.) 700 (typ.) –	20 20 20 20 20	120	Q62703-Q3275 Q62703-Q3276 Q62703-Q3277 Q62703-Q3278 Q62703-Q3279	
	LY T776-PS LY T776-Q LY T776-R LY T776-S LY T776-QT	yellow	587	colorless clear	40 ... 320 63 ... 125 100 ... 200 160 ... 320 63 ... 500	– 300 (typ.) 450 (typ.) 700 (typ.) –	20 20 20 20 20	120	Q62703-Q3280 Q62703-Q3281 Q62703-Q3282 Q62703-Q3283 Q62703-Q3284	
	LB T776 LB T776-J1 LB T776-J2 LB T776-K1 LB T776-K2 LB T776-L1	blue	466	colorless clear	4.0 ... 6.3 5.0 ... 8.0 6.3 ... 10.0 8.0 ... 12.5 10.0 ... 16.0	15 (typ.) 20 (typ.) 25 (typ.) 30 (typ.) 40 (typ.)	10 10 10 10 10	120	Q62703-Q4365	

LC TOPLED® (Niedrigstrom)

LC TOPLED® (Low Current)



	LS T679-CO	super-red	628	colorless clear	1 (≥ 0.25)	3 (typ.)	2	120	Q62703-Q2383	1
	LY T679-CO	yellow	590	colorless clear	1 (≥ 0.25)	3 (typ.)	2	120	Q62703-Q2384	
	LG T679-CO	green	570	colorless clear	1 (≥ 0.25)	3 (typ.)	2	120	Q62703-Q2385	

Lumineszenzdiode

Light Emitting Diodes

SMT-LED

SMT-LEDs

Package	Type	Emissionsfarbe Emission color	λ_{dom} (typ.) [nm]	Farbe der Licht- austrittsfläche Color of light emitting area				2 ϕ (typ.) (50% I _V) [deg].	Bestellnummer Ordering code	Fig.
					I _V [mcd]	Φ_V [mlm]	at I _F [mA]			
Mini TOPLED®					Mini TOPLED®					
	LS M670-HK LS M670-J LS M670-K LS M670-JM	super-red	628	colorless clear	2.5 ... 12.5 4 ... 8 6.3 ... 12.5 4 ... 32	– 18 (typ.) 30 (typ.) –	10 10 10 10	120	Q62703-Q3380 Q62703-Q3381 Q62703-Q3382 Q62703-Q3383	20
	LO M670-HK LO M670-J LO M670-K LO M670-JM	orange	605	colorless clear	2.5 ... 12.5 4 ... 8 6.3 ... 12.5 4 ... 32	– 18 (typ.) 30 (typ.) –	10 10 10 10	120	Q62703-Q3384 Q62703-Q3385 Q62703-Q3386 Q62703-Q3387	
	LY M670-HK LY M670-J LY M670-K LY M670-JM	yellow	590	colorless clear	2.5 ... 12.5 4 ... 8 6.3 ... 12.5 4 ... 32	– 18 (typ.) 30 (typ.) –	10 10 10 10	120	Q62703-Q3388 Q62703-Q3389 Q62703-Q3390 Q62703-Q3391	
	LG M670-HK LG M670-J LG M670-K LG M670-JM	green	570	colorless clear	2.5 ... 12.5 4 ... 8 6.3 ... 12.5 4 ... 32	– 18 (typ.) 30 (typ.) –	10 10 10 10	120	Q62703-Q3392 Q62703-Q3393 Q62703-Q3394 Q62703-Q3395	
	LP M670-FJ LP M670-G LP M670-H LP M670-GK	pure green	560	colorless clear	1 ... 8 1.6 ... 3.2 2.5 ... 5 1.6 ... 12.5	– 8 (typ.) 12 (typ.) –	10 10 10 10	120	Q62703-Q3396 Q62703-Q3397 Q62703-Q3398 Q62703-Q3399	
Hyper Mini TOPLED®					Hyper Mini TOPLED®					
	LS M676-MQ LS M676-N LS M676-P LS M676-Q LS M676-NR	super-red	643	colorless clear	16 ... 125 25 ... 50 40 ... 80 63 ... 125 25 ... 200	– 100 (typ.) 180 (typ.) 300 (typ.) –	20 20 20 20 20	120	Q62703-Q3285 Q62703-Q3288 Q62703-Q3286 Q62703-Q3287 Q62703-Q3289	20
	LA M676-NR LA M676-P LA M676-Q LA M676-R LA M676-PS	amber	615	colorless clear	25 ... 200 40 ... 80 63 ... 125 100 ... 200 40 ... 320	– 180 (typ.) 300 (typ.) 450 (typ.) –	20 20 20 20 20	120	Q62703-Q3536 Q62703-Q3537 Q62703-Q3538 Q62703-Q3539 Q62703-Q3540	
	LO M676-NR LO M676-P LO M676-Q LO M676-R LO M676-PS	orange	610	colorless clear	25 ... 200 40 ... 80 63 ... 125 100 ... 200 40 ... 320	– 180 (typ.) 300 (typ.) 450 (typ.) –	20 20 20 20 20	120	Q62703-Q3290 Q62703-Q3291 Q62703-Q3292 Q62703-Q3293 Q62703-Q3294	
	LY M676-NR LY M676-P LY M676-Q LY M676-R LY M676-PS	yellow	584	colorless clear	25 ... 200 40 ... 80 63 ... 125 100 ... 200 40 ... 320	– 180 (typ.) 300 (typ.) 450 (typ.) –	20 20 20 20 20	120	Q62703-Q3295 Q62703-Q3296 Q62703-Q3297 Q62703-Q3298 Q62703-Q3299	
BLUE LINE™	LB M676 LB M676-J1 LB M676-J2 LB M676-K1 LB M676-K2 LB M676-L1	blue	466	colorless clear	4.0 ... 6.3 5.0 ... 8.0 6.3 ... 10.0 8.0 ... 12.5 10.0 ... 16.0	15 (typ.) 20 (typ.) 25 (typ.) 30 (typ.) 40 (typ.)	10 10 10 10 10	120	Q62703-Q3979	

Lumineszenzdioden

Light Emitting Diodes

SMT-LED

SMT-LEDs

Package	Type	Emissionsfarbe Emission color	λ_{dom} (typ.) [nm]	Farbe der Licht- austrittsfläche Color of light emitting area				2 ϕ (typ.) (50% I _V) [deg].	Bestellnummer Ordering code	Fig.
					I _V [mcd]	Φ_V [mlm]	at I _F [mA]			

Mini TOPLED® RG (Reverse Gullwing)

Mini TOPLED® RG (Reverse Gullwing)

	LS M770-HK LS M770-J LS M770-K LS M770-JM	super-red	628	colorless clear	2.5 ... 12.5 4 ... 8 6.3 ... 12.5 4 ... 32	– 18 (typ.) 30 (typ.) –	10 10 10 10	120	Q62703-Q3326 Q62703-Q3327 Q62703-Q3328 Q62703-Q3329	22
	LO M770-HK LO M770-J LO M770-K LO M770-JM	orange	605	colorless clear	2.5 ... 12.5 4 ... 8 6.3 ... 12.5 4 ... 32	– 18 (typ.) 30 (typ.) –	10 10 10 10	120	Q62703-Q3330 Q62703-Q3331 Q62703-Q3332 Q62703-Q3333	
	LY M770-HK LY M770-J LY M770-K LY M770-JM	yellow	590	colorless clear	2.5 ... 12.5 4 ... 8 6.3 ... 12.5 4 ... 32	– 18 (typ.) 30 (typ.) –	10 10 10 10	120	Q62703-Q3334 Q62703-Q3336 Q62703-Q3335 Q62703-Q3337	
	LG M770-HK LG M770-J LG M770-K LG M770-JM	green	570	colorless clear	2.5 ... 12.5 4 ... 8 6.3 ... 12.5 4 ... 32	– 18 (typ.) 30 (typ.) –	10 10 10 10	120	Q62703-Q3338 Q62703-Q3339 Q62703-Q3340 Q62703-Q3341	
	LP M770-FJ LP M770-G LP M770-H LP M770-GK	pure green	560	colorless clear	1 ... 8 1.6 ... 3.2 2.5 ... 5 1.6 ... 12.5	– 8 (typ.) 12 (typ.) –	10 10 10 10	120	Q62703-Q3342 Q62703-Q3343 Q62703-Q3344 Q62703-Q3345	

LC Mini TOPLED® RG

LC Mini TOPLED® RG

	LS M779-CF LS M779-DG	super-red	628	colorless clear	0.25 ... 0.5 0.40 ... 0.8	3 (typ.)	2	120	Q62703-Q3740 Q62703-Q3744	22
	LY M779-CF LY M779-DG	yellow	590	colorless clear	0.25 ... 0.5 0.40 ... 0.8	3 (typ.)	2	120	Q62703-Q3945 Q62703-Q3946	
	LG M779-CO	green	570	colorless clear	1 (≥ 0.25)	3 (typ.)	2	120	Q62703-Q3050	

Hyper Mini TOPLED® RG (Reverse Gullwing)

Hyper Mini TOPLED® RG (Reverse Gullwing)

	LS M776-MQ LS M776-N LS M776-P LS M776-Q LS M776-NR	super-red	632	colorless clear	16 ... 125 25 ... 50 40 ... 80 63 ... 125 25 ... 200	– 100 (typ.) 180 (typ.) 300 (typ.) –	20 20 20 20 20	120	Q62703-Q3859 Q62703-Q3860 Q62703-Q3861 Q62703-Q3862 Q62703-Q3863	22
	LA M776-NR LA M776-P LA M776-Q LA M776-R LA M776-PS	amber	615	colorless clear	25 ... 200 40 ... 80 63 ... 125 100 ... 200 40 ... 320	– 180 (typ.) 300 (typ.) 450 (typ.) –	20 20 20 20 20	120	Q62703-Q3864 Q62703-Q3865 Q62703-Q3866 Q62703-Q3867 Q62703-Q3868	
	LO M776-NR LO M776-P LO M776-Q LO M776-R LO M776-PS	orange	605	colorless clear	25 ... 200 40 ... 80 63 ... 125 100 ... 200 40 ... 320	– 180 (typ.) 300 (typ.) 450 (typ.) –	20 20 20 20 20	120	Q62703-Q3869 Q62703-Q3870 Q62703-Q3871 Q62703-Q3872 Q62703-Q3873	
	LY M776-NR LY M776-P LY M776-Q LY M776-R LY M776-PS	yellow	587	colorless clear	25 ... 200 40 ... 80 63 ... 125 100 ... 200 40 ... 320	– 180 (typ.) 300 (typ.) 450 (typ.) –	20 20 20 20 20	120	Q62703-Q3874 Q62703-Q3875 Q62703-Q3876 Q62703-Q3877 Q62703-Q3878	

Lumineszenzdioden

Light Emitting Diodes

SMT-LED

SMT-LEDs

Package	Type	Emissionsfarbe Emission color	λ_{dom} (typ.) [nm]	Farbe der Licht- austrittsfläche Color of light emitting area				2 ϕ (typ.) (50% I _V) [deg].	Bestellnummer Ordering code	Fig.
					I _V [mcd]	Φ_V [mlm]	at I _F [mA]			

SIDELED®

SIDELED

	LH A674-KM LH A674-L LH A674-M LH A674-LN	hyper-red	645	colorless clear	6.3 ... 32 10 ... 20 16 ... 32 10 ... 50	– 45 (typ.) 75 (typ.) –	10 10 10 10	120	Q62703-Q2546 Q62703-Q2830 Q62703-Q2831 Q62703-Q2832	19
	LS A670-HL LS A670-J LS A670-K LS A670-L LS A670-JM	super-red	628	colorless clear	2.5 ... 20 4 ... 8 6.3 ... 12.5 10 ... 20 4 ... 32	– 18 (typ.) 30 (typ.) 45 (typ.) –	10 10 10 10 10	120	Q62703-Q3908 Q62703-Q2833 Q62703-Q2834 Q62703-Q3840 Q62703-Q2835	
	LO A670-HK LO A670-J LO A670-K LO A670-L LO A670-JM	orange	605	colorless clear	2.5 ... 12.5 4 ... 8 6.3 ... 12.5 10 ... 20 4 ... 32	– 18 (typ.) 30 (typ.) 45 (typ.) –	10 10 10 10 10	120	Q62703-Q2547 Q62703-Q2837 Q62703-Q3204 Q62703-Q2836 Q62703-Q2838	
	LY A670-HK LY A670-J LY A670-K LY A670-L LY A670-JM	yellow	590	colorless clear	2.5 ... 12.5 4 ... 8 6.3 ... 12.5 10 ... 20 4 ... 32	– 18 (typ.) 30 (typ.) 45 (typ.) –	10 10 10 10 10	120	Q62703-Q2552 Q62703-Q2839 Q62703-Q2840 Q62703-Q3920 Q62703-Q2841	
	LG A670-HK LG A670-J LG A670-K LG A670-L LG A670-JM	green	570	colorless clear	2.5 ... 12.5 4 ... 8 6.3 ... 12.5 10 ... 20 4 ... 32	– 18 (typ.) 30 (typ.) 45 (typ.) –	10 10 10 10 10	120	Q62703-Q2543 Q62703-Q2842 Q62703-Q2843 Q62703-Q3192 Q62703-Q2844	
	LP A670-FJ LP A670-G LP A670-H LP A670-J LP A670-GK	pure green	560	colorless clear	1 ... 8 1.6 ... 3.2 2.5 ... 5 4 ... 8 1.6 ... 12.5	– 8 (typ.) 12 (typ.) 18 (typ.) –	10 10 10 10 10	120	Q62703-Q2549 Q62703-Q2845 Q62703-Q2846 Q62703-Q3214 Q62703-Q2847	

Super SIDELED®

Super SIDELED®

	LS A672-LP LS A672-N LS A672-P LS A672-NR	super-red	628	colorless clear	10 ... 80 25 ... 50 40 ... 80 25 ... 200	– 100 (typ.) 180 (typ.) –	50 50 50 50	120	Q62703-Q2761 Q62703-Q2849 Q62703-Q3226 Q62703-Q2850	19
	LO A672-LP LO A672-N LO A672-P LO A672-NR	orange	605	colorless clear	10 ... 80 25 ... 50 40 ... 80 25 ... 200	– 100 (typ.) 180 (typ.) –	50 50 50 50	120	Q62703-Q2548 Q62703-Q2851 Q62703-Q2852 Q62703-Q2853	
	LY A672-LN LY A672-N LY A672-P LY A672-MQ	yellow	590	colorless clear	10 ... 50 25 ... 50 40 ... 80 16 ... 125	– 100 (typ.) 180 (typ.) –	50 50 50 50	120	Q62703-Q2553 Q62703-Q2854 Q62703-Q2855 Q62703-Q2856	
	LG A672-LP LG A672-N LG A672-P LG A672-MQ	green	570	colorless clear	10 ... 80 25 ... 50 40 ... 80 16 ... 125	– 100 (typ.) 180 (typ.) –	50 50 50 50	120	Q62703-Q2544 Q62703-Q2857 Q62703-Q2858 Q62703-Q2859	
	LP A672-KN LP A672-L LP A672-M LP A672-N LP A672-LP	pure green	560	colorless clear	6.3 ... 50 10 ... 20 16 ... 32 25 ... 50 10 ... 80	– 45 (typ.) 75 (typ.) 100 (typ.) –	50 50 50 50 50	120	Q62703-Q2860 Q62703-Q3838 Q62703-Q3839 Q62703-Q3148 Q62703-Q2863	

■ Nicht für Neuentwicklungen/Not for new design

Lumineszenzdioden

Light Emitting Diodes

SMT-LED

SMT-LEDs

Package	Type	Emissionsfarbe Emission color	λ_{dom} (typ.) [nm]	Farbe der Licht- austrittsfläche Color of light emitting area				2 ϕ (typ.) (50% I _V) [deg].	Bestellnummer Ordering code	Fig.
					I _V [mcd]	Φ_V [mlm]	at I _F [mA]			

LC SIDELED® (Niedrigstrom)

LC SIDELED® (Low Current)

	LS A679-CO	super-red	628	colorless clear	1 ≥ 0.25	3 (typ.)	2	120	Q62703-Q2551	19
	LY A679-CO	yellow	590	colorless clear	1 ≥ 0.25	3 (typ.)	2	120	Q62703-Q2554	
	LG A679-CO	green	570	colorless clear	1 ≥ 0.25	3 (typ.)	2	120	Q62703-Q2545	

Hyper SIDELED®

Hyper SIDELED®

	LS A676-NR LS A676-P LS A676-Q LS A676-R LS A676-PS	super-red	632	colorless clear	25 ... 200 40 ... 80 63 ... 125 100 ... 200 40 ... 320	– 180 (typ.) 300 (typ.) 450 (typ.) –	20 20 20 20 20	120	Q62703-Q3242 Q62703-Q3243 Q62703-Q3244 Q62703-Q3245 Q62703-Q3246	19
	LA A676-PS LA A676-Q LA A676-R LA A676-S LA A676-QT	amber	615	colorless clear	40 ... 320 63 ... 125 100 ... 200 160 ... 320 63 ... 500	– 300 (typ.) 450 (typ.) 700 (typ.) –	20 20 20 20 20	120	Q62703-Q3500 Q62703-Q3501 Q62703-Q3502 Q62703-Q3503 Q62703-Q3504	
	LO A676-PS LO A676-Q LO A676-R LO A676-S LO A676-QT	orange	605	colorless clear	40 ... 320 63 ... 125 100 ... 200 160 ... 320 63 ... 500	– 300 (typ.) 450 (typ.) 700 (typ.) –	20 20 20 20 20	120	Q62703-Q3119 Q62703-Q3120 Q62703-Q3121 Q62703-Q3122 Q62703-Q3118	
	LY A676-PS LY A676-Q LY A676-R LY A676-S LY A676-QT	yellow	587	colorless clear	40 ... 320 63 ... 125 100 ... 200 160 ... 320 63 ... 500	– 300 (typ.) 450 (typ.) 700 (typ.) –	20 20 20 20 20	120	Q62703-Q3251 Q62703-Q3252 Q62703-Q3253 Q62703-Q3254 Q62703-Q3255	
	LB A676 LB A676-J1 LB A676-J2 LB A676-K1 LB A676-K2 LB A676-L1	blue	466	colorless clear	4.0 ... 6.3 5.0 ... 8.0 6.3 ... 10.0 8.0 ... 12.5 10.0 ... 16.0	15 (typ.) 20 (typ.) 25 (typ.) 30 (typ.) 40 (typ.)	10 10 10 10 10	120	Q62703-Q3785	
LW A676 LW A676-L2 LW A676-M1 LW A676-M2 LW A676-N1	white	x=0.30 y=0.32	colored diffused	12.5 ... 20.0 16.0 ... 25.0 20.0 ... 32.0 25.0 ... 40.0	50 (typ.) 60 (typ.) 80 (typ.) 100 (typ.)	10 10 10 10	120	Q62703-Q4731		

Lumineszenzdiode

Light Emitting Diodes

SMT-LED

SMT-LEDs

Package	Type	Emissionsfarbe Emission color	λ_{dom} (typ.) [nm]	Farbe der Licht- austrittsfläche Color of light emitting area	I_V [mcd]			2ϕ (typ.) (50% I_V) [deg].	Bestellnummer Ordering code	Fig.
					color 1	color 2	at I_F [mA]			

Multi TOPLED®

Multi TOPLED®





	LSG T670 LSG T670-J+J LSG T670-J+K LSG T670-J+L LSG T670-K+J LSG T670-K+K LSG T670-K+L LSG T670-L+J LSG T670-L+K LSG T670-L+L	super-red/ green	628/ 570	colorless clear	≥ 4.0 (8 typ.) 4.0 ... 8.0 4.0 ... 8.0 4.0 ... 8.0 6.3 ... 12.5 6.3 ... 12.5 6.3 ... 12.5 6.3 ... 12.5 10.0 ... 20.0 10.0 ... 20.0 10.0 ... 20.0 10.0 ... 20.0	≥ 4.0 (10 typ.) 4.0 ... 8.0 6.3 ... 12.5 10.0 ... 20.0 4.0 ... 8.0 6.3 ... 12.5 10.0 ... 20.0 4.0 ... 8.0 6.3 ... 12.5 10.0 ... 20.0	10 10 10 10 10 10 10 10 10 10 10 10	120	Q62703-Q4316	2
	LSY T670 LSY T670-J+J LSY T670-J+K LSY T670-J+L LSY T670-K+J LSY T670-K+K LSY T670-K+L LSY T670-L+J LSY T670-L+K LSY T670-L+L	super-red/ yellow	628/ 590	colorless clear	≥ 4.0 (8 typ.) 4.0 ... 8.0 4.0 ... 8.0 4.0 ... 8.0 6.3 ... 12.5 6.3 ... 12.5 6.3 ... 12.5 6.3 ... 12.5 10.0 ... 20.0 10.0 ... 20.0 10.0 ... 20.0	≥ 4.0 (10 typ.) 4.0 ... 8.0 6.3 ... 12.5 10.0 ... 20.0 4.0 ... 8.0 6.3 ... 12.5 10.0 ... 20.0 4.0 ... 8.0 6.3 ... 12.5 10.0 ... 20.0	10 10 10 10 10 10 10 10 10 10 10	120	Q62703-Q4317	
	LSP T670 LSP T670-H+G LSP T670-H+H LSP T670-J+G LSP T670-J+H LSP T670-J+J LSP T670-K+G LSP T670-K+H LSP T670-K+J	super-red/ pure green	628/ 560	colorless clear	≥ 4.0 (8 typ.) 2.5 ... 5.0 2.5 ... 5.0 4.0 ... 8.0 4.0 ... 8.0 4.0 ... 8.0 6.3 ... 12.5 6.3 ... 12.5 6.3 ... 12.5	≥ 1.6 (3 typ.) 1.6 ... 3.2 2.5 ... 5.0 1.6 ... 3.2 2.5 ... 5.0 4.0 ... 8.0 1.6 ... 3.2 2.5 ... 5.0 4.0 ... 8.0	10 10 10 10 10 10 10 10 10	120	Q62703-Q4318	
	LYG T670 LYG T670-J+J LYG T670-J+K LYG T670-J+L LYG T670-K+J LYG T670-K+K LYG T670-K+L LYG T670-L+J LYG T670-L+K LYG T670-L+L	yellow/ green	590/ 570	colorless clear	≥ 4.0 (9 typ.) 4.0 ... 8.0 4.0 ... 8.0 4.0 ... 8.0 6.3 ... 12.5 6.3 ... 12.5 6.3 ... 12.5 10.0 ... 20.0 10.0 ... 20.0 10.0 ... 20.0	≥ 4.0 (10 typ.) 4.0 ... 8.0 6.3 ... 12.5 10.0 ... 20.0 4.0 ... 8.0 6.3 ... 12.5 10.0 ... 20.0 4.0 ... 8.0 6.3 ... 12.5 10.0 ... 20.0	10 10 10 10 10 10 10 10 10 10	120	Q62703-Q4502	
	LOP T670 LOP T670-J+G LOP T670-J+H LOP T670-J+J LOP T670-K+G LOP T670-K+H LOP T670-K+J	orange/ pure green	605/ 570	colorless clear	≥ 4.0 (8 typ.) 4.0 ... 8.0 4.0 ... 8.0 4.0 ... 8.0 6.3 ... 12.5 6.3 ... 12.5 6.3 ... 12.5	≥ 1.6 (3 typ.) 1.6 ... 3.2 2.5 ... 5.0 4.0 ... 8.0 1.6 ... 3.2 2.5 ... 5.0 4.0 ... 8.0	10 10 10 10 10 10 10	120	Q62703-Q4319	
	LOG T671 LOG T671-J+K LOG T671-J+L LOG T671-J+M LOG T671-K+K LOG T671-K+L LOG T671-K+M LOG T671-L+M	orange/ green	605/ 570	colorless clear	≥ 4.0 (8 typ.) 4.0 ... 8.0 4.0 ... 8.0 4.0 ... 8.0 6.3 ... 12.5 6.3 ... 12.5 6.3 ... 12.5 10.0 ... 20.0	≥ 6.3 (15 typ.) 6.3 ... 12.5 10.0 ... 20.0 16.0 ... 32.0 6.3 ... 12.5 10.0 ... 20.0 16.0 ... 32.0 16.0 ... 32.0	10 10 10 10 10 10 10 10	120	Q62703-Q4320	
	LSG T671 LSG T671-J+K LSG T671-J+L LSG T671-J+M LSG T671-K+K LSG T671-K+L LSG T671-K+M LSG T671-L+K LSG T671-L+L LSG T671-L+M	super-red/ green	628/ 570	colorless clear	≥ 4.0 (8 typ.) 4.0 ... 8.0 4.0 ... 8.0 4.0 ... 8.0 6.3 ... 12.5 6.3 ... 12.5 6.3 ... 12.5 10.0 ... 20.0 10.0 ... 20.0 10.0 ... 20.0	≥ 6.3 (15 typ.) 6.3 ... 12.5 10.0 ... 20.0 16.0 ... 32.0 6.3 ... 12.5 10.0 ... 20.0 16.0 ... 32.0 6.3 ... 12.5 10.0 ... 20.0 16.0 ... 32.0	10 10 10 10 10 10 10 10 10 10	120	Q62703-Q4321	

Lumineszenzdioden

Light Emitting Diodes

SMT-LED

SMT-LEDs

Package	Type	Emissionsfarbe Emission color	λ_{dom} (typ.) [nm]	Farbe der Licht- austrittsfläche Color of light emitting area	I_V [mcd]		at I_F [mA]	2ϕ (typ.) (50% I_V) [deg].	Bestellnummer Ordering code	Fig.
					color 1	color 2				
Multi TOPLED® (Kathoden auf einer Seite)					Multi TOPLED® (Cathodes on one side)					
	LSG T677 LSG T677-J+J LSG T677-J+K LSG T677-J+L LSG T677-K+J LSG T677-K+K LSG T677-K+L LSG T677-L+J LSG T677-L+K LSG T677-L+L	super-red/ green	628/ 570	colorless clear	≥ 4.0 (8 typ.) 4.0 ... 8.0 4.0 ... 8.0 4.0 ... 8.0 6.3 ... 12.5 6.3 ... 12.5 6.3 ... 12.5 10.0 ... 20.0 10.0 ... 20.0 10.0 ... 20.0	≥ 4.0 (10 typ.) 4.0 ... 8.0 6.3 ... 12.5 10.0 ... 20.0 4.0 ... 8.0 6.3 ... 12.5 10.0 ... 20.0 4.0 ... 8.0 6.3 ... 12.5 10.0 ... 20.0	10 10 10 10 10 10 10 10 10 10	120	Q62703-Q4327	8
Hyper Multi TOPLED®					Hyper Multi TOPLED®					
	LSY T676 LSY T676-P+P LSY T676-P+Q LSY T676-P+R LSY T676-Q+Q LSY T676-Q+R	super-red / yellow	628/ 590	colorless clear	≥ 40 40 ... 80 40 ... 80 40 ... 80 63 ... 125 63 ... 125	≥ 40 40 ... 80 63 ... 125 100 ... 200 63 ... 125 100 ... 200	20 20 20 20 20 20	120	Q62703-Q3428	2
Multi TOPLED® RG (Reverse Gullwing)					Multi TOPLED® RG (Reverse Gullwing)					
	LSG T770 LSG T770-J+J LSG T770-J+K LSG T770-J+L LSG T770-K+J LSG T770-K+K LSG T770-K+L LSG T770-L+J LSG T770-L+K LSG T770-L+L	super-red/ green	628/ 570	colorless clear	≥ 4.0 (8 typ.) 4.0 ... 8.0 4.0 ... 8.0 4.0 ... 8.0 6.3 ... 12.5 6.3 ... 12.5 6.3 ... 12.5 10.0 ... 20.0 10.0 ... 20.0 10.0 ... 20.0	≥ 4.0 (10 typ.) 4.0 ... 8.0 6.3 ... 12.5 10.0 ... 20.0 4.0 ... 8.0 6.3 ... 12.5 10.0 ... 20.0 4.0 ... 8.0 6.3 ... 12.5 10.0 ... 20.0	10 10 10 10 10 10 10 10 10 10	120	Q62703-Q4328	14
Super Multi TOPLED®					Super Multi TOPLED®					
	LPP T672-MO	pure-green/ pure-green	560/ 560	colorless clear	I_V [mcd] 40 (≥ 16)	Φ_V [mim] 120 (typ.)	50	120	Q62703-Q2885	2
Multi SIDELED®					Multi SIDELED®					
	LOG A671 LOG A671-J+K LOG A671-J+L LOG A671-J+M LOG A671-K+K LOG A671-K+L LOG A671-K+M LOG A671-L+M	orange/ green	605/ 570	colorless clear	≥ 4.0 (8 typ.) 4.0 ... 8.0 4.0 ... 8.0 4.0 ... 8.0 6.3 ... 12.5 6.3 ... 12.5 6.3 ... 12.5 10.0 ... 20.0	≥ 6.3 (15 typ.) 6.3 ... 12.5 10.0 ... 20.0 16.0 ... 32.0 6.3 ... 12.5 6.3 ... 12.5 10.0 ... 20.0 16.0 ... 32.0 16.0 ... 32.0	10 10 10 10 10 10 10 10 10 10	120	Q62703-Q4322	21
	LSG A671 LSG A671-J+K LSG A671-J+L LSG A671-J+M LSG A671-K+K LSG A671-K+L LSG A671-K+M LSG A671-L+K LSG A671-L+L LSG A671-L+M	super-red/ green	628/ 570	colorless clear	≥ 4.0 (8 typ.) 4.0 ... 8.0 4.0 ... 8.0 4.0 ... 8.0 6.3 ... 12.5 6.3 ... 12.5 6.3 ... 12.5 10.0 ... 20.0 10.0 ... 20.0 10.0 ... 20.0	≥ 6.3 (15 typ.) 6.3 ... 12.5 10.0 ... 20.0 16.0 ... 32.0 6.3 ... 12.5 6.3 ... 12.5 10.0 ... 20.0 16.0 ... 32.0 6.3 ... 12.5 10.0 ... 20.0 16.0 ... 32.0	10 10 10 10 10 10 10 10 10 10	120	Q62703-Q4323	

Lumineszenzdioden

Light Emitting Diodes

SMT-LED

SMT-LEDs

Package	Type	Emissionsfarbe Emission color	λ_{dom} (typ.) [nm]	Farbe der Licht- austrittsfläche Color of light emitting area	I_V [mcd]		at I_F [mA]	2 ϕ (typ.) (50% I_V) [deg].	Bestellnummer Ordering code	Fig.
					color 1	color 2				

Hyper Multi SIDELED®

Hyper Multi SIDELED®

Package	Type	Emissionsfarbe Emission color	λ_{dom} (typ.) [nm]	Farbe der Licht- austrittsfläche Color of light emitting area	I_V [mcd]		at I_F [mA]	2 ϕ (typ.) (50% I_V) [deg].	Bestellnummer Ordering code	Fig.
					color 1	color 2				
	LSY A676	super-red/ yellow	632/ 587	colorless clear	≥ 40	≥ 40	20	120	Q62703-Q3374	21
	LSY A676-P+P				40 ... 80	40 ... 80				
	LSY A676-P+Q				40 ... 80	63 ... 125				
	LSY A676-P+R				40 ... 80	100 ... 200				
	LSY A676-Q+Q				63 ... 125	63 ... 125				
	LSY A676-Q+R				63 ... 125	100 ... 200				

Package	Type	Emissionsfarbe Emission color	λ_{dom} (typ.) [nm]	Farbe der Licht- austrittsfläche Color of light emitting area	I_V [mcd]		at I_F [mA]	2 ϕ (typ.) (50% I_V) [deg].	Bestellnummer Ordering code	Fig.
					I_V [mcd]	Φ_V [mlm]				

SMT SOT-23 LED

SMT SOT-23 LEDs

Package	Type	Emissionsfarbe Emission color	λ_{dom} (typ.) [nm]	Farbe der Licht- austrittsfläche Color of light emitting area	I_V [mcd]		at I_F [mA]	2 ϕ (typ.) (50% I_V) [deg].	Bestellnummer Ordering code	Fig.
					I_V [mcd]	Φ_V [mlm]				
	LS S260-DO	super-red	628	red diffused	≥ 0.4	–	10	140	Q62703-Q1640	9
	LY S260-DO	yellow	590	yellow diffused	≥ 0.4	–	10	140	Q62703-Q1657	
	LG S260-DO	green	570	green diffused	≥ 0.4	–	10	140	Q62703-Q1608	

SMT LC SOT-23 LED (Niedrigstrom)

SMT LC SOT-23 LEDs (Low Current)

Package	Type	Emissionsfarbe Emission color	λ_{dom} (typ.) [nm]	Farbe der Licht- austrittsfläche Color of light emitting area	I_V [mcd]		at I_F [mA]	2 ϕ (typ.) (50% I_V) [deg].	Bestellnummer Ordering code	Fig.
					I_V [mcd]	Φ_V [mlm]				
	LS S269-BO	super-red	628	red diffused	≥ 0.16	–	2	140	Q62703-Q1566	9
	LY S269-BO	yellow	590	yellow diffused	≥ 0.16	–	2	140	Q62703-Q1568	
	LG S269-BO	green	570	green diffused	≥ 0.16	–	2	140	Q62703-Q1570	

SOT-23 MULTILED®

SOT-23 MULTILED®

Package	Type	Emissionsfarbe Emission color	λ_{dom} (typ.) [nm]	Farbe der Licht- austrittsfläche Color of light emitting area	I_V [mcd]	Φ_V [mlm]	at I_F [mA]	2 ϕ (typ.) (50% I_V) [deg].	Bestellnummer Ordering code	Fig.
	LU S250-DO	super-red/ green	628/ 570	colorless diffused	≥ 0.4	–	10	140	Q62703-Q1642	9

Lumineszenzdioden

Light Emitting Diodes

CHIPLED

$I_F = 20 \text{ mA}$, $T_A = 25 \text{ °C}$

CHIPLED

$I_F = 20 \text{ mA}$, $T_A = 25 \text{ °C}$

Package	Type	I_V mcd		I_F mA	λ_{peak} nm	λ_{dom} nm	$\Delta\lambda$ nm	V_F V		I_F max mA	P_{tot} mW	R_{th} K/W	Color	Ordering code	Fig.
		min	typ					typ	max						

CHIPLED 0805

	LG R971	10	20	20	570	572	30	2.2	2.6	25	65	800 ²⁾	colorless diffused	Q62702-P5179	23
	LO R971	4.0	8.0	20	610	605	40	2.2	2.6	25	65	800 ²⁾	colorless diffused	Q62702-P5180	
	LY R971	2.5	6.0	20	589	592	35	2.2	2.6	25	65	800 ²⁾	colorless diffused	Q62702-P5181	
	LH R974	10	20	20	660	645	20	1.8	2.6	30	78	800 ²⁾	colorless diffused	Q62702-P5182	24

Hyper CHIPLED 0805

	LB R99A	1.6	6	20	428	466	60	3.8	4.5	20	90	450 ²⁾	colorless clear	Q62702-P5175	29
	LO R976	25	70	20	610	605	16	2.0	2.6	25	65	550 ²⁾	colorless diffused	Q62702-P5176	23
	LY R976	25	60	20	591	587	15	2.0	2.6	25	65	550 ²⁾	colorless diffused	Q62702-P5177	
	LS R976	16	50	20	645	632	16	2.0	2.6	25	65	550 ²⁾	colorless diffused	Q62702-P5178	
	LW R98A	10	25	20	X = 0.28	Y = 0.28	–	3.8	4.5	20	90	450 ²⁾	colored diffused	Q62702-P5183	29

CHIPLED 0603

	LG Q971	10	20	20	570	572	30	2.2	2.6	25	65	800 ²⁾	colorless diffused	Q62702-P5189	25
	LY Q971	2.5	6.0	20	589	592	40	2.2	2.6	25	65	800 ²⁾	colorless diffused	Q62703-Q4699	
	LH Q974	10	20	20	660	645	20	1.8	2.6	30	78	800 ²⁾	colorless diffused	Q62702-P5190	26

Hyper CHIPLED 0603

	LY Q976	25	60	20	591	587	15	2.0	2.4	25	60	900 ²⁾	colorless diffused	Q62702-P5186	25
	LS Q976	16	50	20	645	632	16	2.0	2.6	25	65	900 ²⁾	colorless diffused	Q62702-P5187	
	LO Q976	25	70	20	610	605	16	2.0	2.6	25	65	900 ²⁾	colorless diffused	Q62702-P5188	
	LB Q99A	1.6	4	10	428	466	60	3.5	4.2	15	65	800 ²⁾	colorless clear	Q62702-P5184	30
	LW Q98A	6.3	15	10	X = 0.28	Y = 0.28	–	3.5	4.2	15	65	800 ²⁾	colored diffused	Q62702-P5185	

CHIPLED 1206

	LG N971	10	15	20	570	572	30	2.2	2.6	25	65	700 ²⁾	colorless diffused	Q62702-P5191	27
	LY N971	2.5	4.5	20	589	592	40	2.2	2.6	25	65	700 ²⁾	colorless diffused	Q62702-P5193	
	LH N974	10	20	20	660	645	20	1.8	2.6	30	78	750 ²⁾	colorless diffused	Q62702-P5192	

Multi CHIPLED

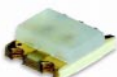
	LSG F971¹⁾ super red	6.3	11	20	642	628	40	2.3	2.6	25	65	750 ²⁾	colorless diffused	Q62703-Q4728	28
	LSG F971¹⁾ green	10	21	20	570	572	30	2.3	2.6	25	65	750 ²⁾	colorless diffused		

¹⁾ Nur ein Chip betrieben
²⁾ Vorläufige Daten

¹⁾ one system only
²⁾ Preliminary Data

Lumineszenzdioden

Light Emitting Diodes

Radiale LED

Radial LEDs

Package	Type	Emissionsfarbe Emission color	λ_{dom} (typ.) [nm]	Gehäusefarbe Emission Color	at			2 ϕ (typ.) (50% I _V) [deg].	Bestellnummer Ordering code	Fig.	
					I _V [mcd]	Φ_V [mlm]	I _F [mA]				
3 mm LED											
3 mm LEDs											
	LH 3344-QT LH 3344-R LH 3344-S LH 3344-T LH 3344-RU	hyper-red	645	red clear	63 ... 500 100 ... 200 160 ... 320 250 ... 500 100 ... 800	— — — — —	10 10 10 10 10	25	Q62703-Q2231 Q62703-Q3198 Q62703-Q3199 Q62703-Q3817 Q62703-Q3200	5	
	LS 3341-LP LS 3341-M LS 3341-N LS 3341-P LS 3341-MQ	super-red	628	red clear	10 ... 80 16 ... 32 25 ... 50 40 ... 80 16 ... 125	— — — — —	10 10 10 10 10	40	Q62703-Q3911 Q62703-Q2146 Q62703-Q2147 Q62703-Q3445 Q62703-Q2148		
	LY 3341-LP LY 3341-M LY 3341-N LY 3341-P LY 3341-MQ	yellow	590	yellow clear	10 ... 80 16 ... 32 25 ... 50 40 ... 80 60 ... 125	— — — — —	10 10 10 10 10	40	Q62703-Q2152 Q62703-Q2151 Q62703-Q2398 Q62703-Q3234 Q62703-Q2149		
	LG 3341-KN LG 3341-N LG 3341-M LG 3341-MQ	green	570	green clear	6.3 ... 50 16 ... 32 25 ... 50 16 ... 125	— — — —	10 10 10 10	40	Q62703-Q2153 Q62703-Q2155 Q62703-Q3187 Q62703-Q2156		
	LP 3341-JM LP 3341-K LP 3341-L LP 3341-M LP 3341-KN	pure green	560	colorless clear	4 ... 32 6.3 ... 12.5 10 ... 20 16 ... 32 6.3 ... 50	— — — — —	10 10 10 10 10	40	Q62703-Q3815 Q62703-Q3816 Q62703-Q2986 Q62703-Q2919 Q62703-Q2750		
	LS 3340-KN LS 3340-L LS 3340-M LS 3340-N LS 3340-LP	super-red	628	red clear	6.3 ... 50 10 ... 20 16 ... 32 25 ... 50 10 ... 80	— — — — —	10 10 10 10 10	50	Q62703-Q1701 Q62703-Q1702 Q62703-Q1704 Q62703-Q2320 Q62703-Q3223		4
	LO 3340-KN LO 3340-L LO 3340-M LO 3340-N LO 3340-LP	orange	605	orange clear	6.3 ... 50 10 ... 20 16 ... 32 25 ... 50 10 ... 80	— — — — —	10 10 10 10 10	50	Q62703-Q1886 Q62703-Q2256 Q62703-Q2255 Q62703-Q2473 Q62703-Q2628		
	LY 3340-JM LY 3340-L LY 3340-M LY 3340-N LY 3340-LP	yellow	590	yellow clear	4 ... 32 10 ... 20 16 ... 32 25 ... 50 10 ... 80	— — — — —	10 10 10 10 10	50	Q62703-Q1789 Q62703-Q1791 Q62703-Q1999 Q62703-Q2652 Q62703-Q1792		
	LG 3330-KN LG 3330-L LG 3330-M LG 3330-N LG 3330-LP	green	570	colorless clear	6.3 ... 50 10 ... 20 16 ... 32 25 ... 50 10 ... 80	— — — — —	10 10 10 10 10	50	Q62703-Q1698 Q62703-Q1699 Q62703-Q1700 Q62703-Q2010 Q62703-Q2011		
	LP 3340-JL LP 3340-K LP 3340-L LP 3340-KM	pure green	560	green clear	4 ... 20 6.3 ... 12.5 10 ... 20 6.3 ... 32	— — — —	10 10 10 10	50	Q62703-Q2749 Q62703-Q2982 Q62703-Q2980 Q62703-Q3211		
LR 3360-DG LR 3360-F LR 3360-G LR 3360-FJ	red	645	red diffused	0.4 ... 3.2 1 ... 2 1.6 ... 3.2 1 ... 8	— — — —	10 10 10 10	70	Q62703-Q1316 Q62703-Q1317 Q62703-Q1318 Q62703-Q1319			
LH 3364-LP LH 3364-M LH 3364-N LH 3364-MQ	hyper-red	645	red diffused	10 ... 80 16 ... 32 25 ... 50 16 ... 125	— — — —	10 10 10 10	45	Q62703-Q3202 Q62703-Q3203 Q62703-Q2798 Q62703-Q3201			
LS 3360-HL LS 3360-K LS 3360-L LS 3360-KN	super-red	628	red diffused	2.5 ... 20 6.3 ... 12.5 10 ... 20 6.3 ... 50	— — — —	10 10 10 10	70	Q62703-Q1320 Q62703-Q1321 Q62703-Q1322 Q62703-Q1323			

Lumineszenzdiode

Light Emitting Diodes

Radiale LED

Radial LEDs

Package	Type	Emissionsfarbe Emission color	λ_{dom} (typ.) [nm]	Gehäusefarbe Emission Color	at			2 ϕ (typ.) (50% I _V) [deg.]	Bestellnummer Ordering code	Fig.
					I _V [mcd]	Φ_V [mlm]	I _F [mA]			

3 mm LED (Forts.)

3 mm LEDs (cont'd)

	LO 3360-HL LO 3360-K LO 3360-L LO 3360-JM	orange	605	orange diffused	2.5 ... 20 6.3 ... 12.5 10 ... 20 4 ... 32	— — — —	10 10 10 10	70	Q62703-Q1887 Q62703-Q2400 Q62703-Q2596 Q62703-Q2410	4
	LY 3360-HL LY 3360-K LY 3360-L LY 3360-KN	yellow	590	yellow diffused	2.5 ... 20 6.3 ... 12.5 10 ... 20 6.3 ... 50	— — — —	10 10 10 10	70	Q62703-Q1324 Q62703-Q1325 Q62703-Q1326 Q62703-Q1998	
	LG 3360-HL LG 3360-J LG 3360-K LG 3360-L LG 3360-KN	green	570	green diffused	2.5 ... 20 4 ... 8 6.3 ... 12.5 10 ... 20 6.3 ... 50	— — — — —	10 10 10 10 10	70	Q62703-Q3818 Q62703-Q1865 Q62703-Q2008 Q62703-Q3507 Q62703-Q3819	
	LP 3360-GK LP 3360-H LP 3360-J LP 3360-HL	pure green	560	colorless clear	1.6 ... 12.5 2.5 ... 5 4 ... 8 2.5 ... 20	— — — —	10 10 10 10	70	Q62703-Q2467 Q62703-Q2914 Q62703-Q2915 Q62703-Q3213	

Hyper 3 mm LED

Hyper 3 mm LEDs

	LS 3336-QT LS 3336-R LS 3336-S LS 3336-T LS 3336-RU	super-red	632	colorless clear	63 ... 500 100 ... 200 160 ... 320 250 ... 500 100 ... 800	— — — — —	20 20 20 20 20	40	Q62703-Q3482 Q62703-Q3484 Q62703-Q3485 Q62703-Q3813 Q62703-Q3486	4
	LA 3336-RU LA 3336-S LA 3336-T LA 3336-U LA 3336-SV	amber	615	colorless clear	100 ... 800 160 ... 320 250 ... 500 400 ... 800 160 ... 1250	— — — — —	20 20 20 20 20	50	Q62703-Q3554 Q62703-Q3551 Q62703-Q3552 Q62703-Q3553 Q62703-Q3555	
	LO 3336-RU LO 3336-S LO 3336-T LO 3336-U LO 3336-SV	orange	605	colorless clear	100 ... 800 160 ... 320 250 ... 500 400 ... 800 160 ... 1250	— — — — —	20 20 20 20 20	40	Q62703-Q3144 Q62703-Q3176 Q62703-Q3170 Q62703-Q3307 Q62703-Q3177	
	LY 3336-RU LY 3336-S LY 3336-T LY 3336-U LY 3336-SV	yellow	587	colorless clear	100 ... 800 160 ... 320 250 ... 500 400 ... 800 160 ... 1250	— — — — —	20 20 20 20 20	40	Q62703-Q3487 Q62703-Q3489 Q62703-Q3490 Q62703-Q3814 Q62703-Q3491	
	LB 3336 LB 3336-M LB 3336-N LB 3336-P LB 3336-Q	blue	466	colorless clear	16 ... 32 25 ... 50 40 ... 80 63 ... 125	— — — —	10 10 10 10	50	Q62703-Q4068	
	LS 3366-NR LS 3366-P LS 3366-Q LS 3366-R LS 3366-PS	super-red	632	super-red diffused	25 ... 200 40 ... 80 63 ... 125 100 ... 200 40 ... 320	— — — — —	20 20 20 20 20	70	Q62703-Q3457 Q62703-Q3458 Q62703-Q3459 Q62703-Q3460 Q62703-Q3461	
	LA 3366-PS LA 3366-Q LA 3366-R LA 3366-S LA 3366-QT	amber	615	orange diffused	40 ... 320 63 ... 125 100 ... 200 160 ... 320 63 ... 500	— — — — —	20 20 20 20 20	70	Q62703-Q3881 Q62703-Q3882 Q62703-Q3883 Q62703-Q3884 Q62703-Q3885	
	LO 3366-PS LO 3366-Q LO 3366-R LO 3366-S LO 3366-QT	orange	605	orange diffused	40 ... 320 63 ... 125 100 ... 200 160 ... 320 63 ... 500	— — — — —	20 20 20 20 20	70	Q62703-Q3127 Q62703-Q3172 Q62703-Q3173 Q62703-Q3174 Q62703-Q3175	

Lumineszenzdioden

Light Emitting Diodes

Radiale LED

Radial LEDs

Package	Type	Emissionsfarbe Emission color	λ_{dom} (typ.) [nm]	Gehäusefarbe Emission Color	at			2 ϕ (typ.) (50% I _V) [deg.]	Bestellnummer Ordering code	Fig.
					I _V [mcd]	Φ_V [mlm]	I _F [mA]			

Hyper 3 mm LED (Forts.)

Hyper 3 mm LEDs (cont'd)

	LY 3366-PS LY 3366-Q LY 3366-R LY 3366-S LY 3366-QT	yellow	587	yellow diffused	40 ... 320 63 ... 125 100 ... 200 160 ... 320 63 ... 500	– – – – –	20 20 20 20 20	70	Q62703-Q3462 Q62703-Q3464 Q62703-Q3465 Q62703-Q3463 Q62703-Q3466	4
	BLUE LINE™ LB 3356 LB 3356-J LB 3356-K LB 3356-L	blue	466	colorless diffused	4.0 ... 8.0 6.3 ... 12.5 10.0 ... 20.0	– – –	10 10 10	70	Q62703-Q4192	

3 mm LED

3 mm LEDs

	LS 3380-GK LS 3380-H LS 3380-J LS 3380-K LS 3380-HL	super-red	628	red diffused	1.6 ... 12.5 2.5 ... 5.0 4.0 ... 8.0 6.3 ... 12.5 2.5 ... 20.0	– – – – –	10 10 10 10 10	100	Q62703-Q2629 Q62703-Q1726 Q62703-Q1349 Q62703-Q3824 Q62703-Q2630	4
	LY 3380-GK LY 3380-H LY 3380-J LY 3380-K LY 3380-HL	yellow	590	yellow diffused	1.6 ... 12.5 2.5 ... 5.0 4.0 ... 8.0 6.3 ... 12.5 2.5 ... 20.0	– – – – –	10 10 10 10 10	100	Q62703-Q1352 Q62703-Q1353 Q62703-Q1354 Q62703-Q2317 Q62703-Q1355	
	LG 3380-GK LG 3380-J LG 3380-K LG 3380-JL	green	570	green diffused	1.6 ... 12.5 4.0 ... 8.0 6.3 ... 12.5 4.0 ... 20.0	– – – –	10 10 10 10	100	Q62703-Q1356 Q62703-Q2318 Q62703-Q2631 Q62703-Q3910	

Hyper 3 mm LED

Hyper 3 mm LEDs

	LS 3386-LP LS 3386-M LS 3386-N LS 3386-P LS 3386-MQ	super-red	632	red diffused	10 ... 80 16 ... 32 25 ... 50 40 ... 80 16 ... 125	– – – – –	20 20 20 20 20	100	Q62703-Q3579 Q62703-Q3581 Q62703-Q3582 Q62703-Q3709 Q62703-Q3580	4
	LA 3386-MQ LA 3386-N LA 3386-P LA 3386-Q LA 3386-NR	amber	615	orange diffused	16 ... 125 25 ... 50 40 ... 80 63 ... 125 25 ... 200	– – – – –	20 20 20 20 20	100	Q62703-Q3886 Q62703-Q3887 Q62703-Q3888 Q62703-Q3889 Q62703-Q3890	
	LO 3386-MQ LO 3386-N LO 3386-P LO 3386-Q LO 3386-NR	orange	605	orange diffused	16 ... 125 25 ... 50 40 ... 80 63 ... 125 25 ... 200	– – – – –	20 20 20 20 20	100	Q62703-Q3891 Q62703-Q3892 Q62703-Q3893 Q62703-Q3894 Q62703-Q3895	
	LY 3386-MQ LY 3386-N LY 3386-P LY 3386-Q LY 3386-NR	yellow	587	yellow diffused	16 ... 125 25 ... 50 40 ... 80 63 ... 125 25 ... 200	– – – – –	20 20 20 20 20	100	Q62703-Q3896 Q62703-Q3897 Q62703-Q3898 Q62703-Q3899 Q62703-Q3900	

LC (Niedrigstrom) 3 mm LED

LC (Low Current) 3 mm LEDs

	LS 3369-EH LS 3369-G LS 3369-H LS 3369-GK	super-red	628	red diffused	0.63 ... 5.0 1.60 ... 3.2 2.50 ... 5.0 1.60 ... 12.5	– – – –	2 2 2 2	60	Q62703-Q1748 Q62703-Q2068 Q62703-Q3820 Q62703-Q3821	4
	LY 3369-EH LY 3369-F LY 3369-G LY 3369-H LY 3369-FJ	yellow	590	yellow diffused	0.63 ... 5.0 1.00 ... 2.0 1.60 ... 3.2 2.50 ... 5.0 1.00 ... 8.0	– – – – –	2 2 2 2 2	60	Q62703-Q1749 Q62703-Q2030 Q62703-Q2029 Q62703-Q1906 Q62703-Q3822	

Lumineszenzdioden

Light Emitting Diodes

Radiale LED

Radial LEDs

Package	Type	Emissionsfarbe Emission color	λ_{dom} (typ.) [nm]	Gehäusefarbe Emission Color				2 ϕ (typ.) (50% I _V) [deg].	Bestellnummer Ordering code	Fig.
					I _V [mcd]	Φ_V [mlm]	at I _F [mA]			

LC (Niedrigstrom) 3 mm LED (Forts.)

LC (Low Current) 3 mm LEDs (cont'd)

	LG 3369-EH	green	570	green diffused	0.63 ... 5.0	–	2	60	Q62703-Q1750 Q62703-Q2069 Q62703-Q2070 Q62703-Q3823	4
	LG 3369-F				1.00 ... 2.0	–	2			
	LG 3369-G				1.60 ... 3.2	–	2			
	LG 3369-FJ				1.00 ... 8.0	–	2			

3 mm MULTILED®¹⁾

3 mm MULTILED®¹⁾

	LSG 3331-JO	super-red/ green	628/ 570	colorless clear	18 (≥ 4)	–	10	40	Q62703-Q2296	6
	LSG 3351-HO	super-red/ green	628/ 570	colorless diffused	10 (≥ 2.5)	–	10	50	Q62703-Q2297	

¹⁾ weitere Chipkombinationen auf Anfrage

¹⁾ other chip combinations on request.

5 mm LED

5 mm LEDs

	LH 5424-QT LH 5424-S LH 5424-T LH 5424-SU	hyper-red	645	red clear	63 ... 500 160 ... 320 250 ... 500 160 ... 800	– – – –	10 10 10 10	16	Q62703-Q2242 Q62703-Q3826 Q62703-Q3827 Q62703-Q3828	7
	LS 5421-NR LS 5421-Q LS 5421-R LS 5421-S LS 5421-QT	super-red	628	red clear	25 ... 200 63 ... 125 100 ... 200 160 ... 320 63 ... 500	– – – – –	10 10 10 10 10	20	Q62703-Q1994 Q62703-Q1442 Q62703-Q1738 Q62703-Q2405 Q62703-Q1995	
	LO 5411-QT LO 5411-R LO 5411-S LO 5411-T LO 5411-RU	orange	605	colorless clear	63 ... 500 100 ... 200 160 ... 320 250 ... 500 100 ... 800	– – – – –	10 10 10 10 10	20	Q62703-Q3928 Q62703-Q3929 Q62703-Q3930 Q62703-Q3931 Q62703-Q3932	
	LY 5421-NR LY 5421-Q LY 5421-R LY 5421-S LY 5421-QT	yellow	590	yellow clear	25 ... 200 63 ... 125 100 ... 200 160 ... 320 63 ... 500	– – – – –	10 10 10 10 10	20	Q62703-Q1444 Q62703-Q1446 Q62703-Q2005 Q62703-Q2632 Q62703-Q1447	
	LG 5411-NR LG 5411-Q LG 5411-R LG 5411-S LG 5411-QT	green	570	colorless clear	25 ... 200 63 ... 125 100 ... 200 160 ... 320 63 ... 500	– – – – –	10 10 10 10 10	20	Q62703-Q2023 Q62703-Q1739 Q62703-Q1451 Q62703-Q2321 Q62703-Q2024	
	LS 5420-MQ LS 5420-P LS 5420-Q LS 5420-R LS 5420-PT	super-red	628	red clear	16 ... 125 40 ... 80 63 ... 125 100 ... 200 40 ... 500	– – – – –	10 10 10 10 10	24	Q62703-Q1428 Q62703-Q1430 Q62703-Q1993 Q62703-Q1429 Q62703-Q1431	
	LY 5420-MQ LY 5420-P LY 5420-Q LY 5420-R LY 5420-PS	yellow	590	yellow clear	16 ... 125 40 ... 80 63 ... 125 100 ... 200 40 ... 320	– – – – –	10 10 10 10 10	24	Q62703-Q1432 Q62703-Q1434 Q62703-Q2004 Q62703-Q3235 Q62703-Q1435	
	LG 5410-MQ LG 5410-P LG 5410-Q LG 5410-R LG 5410-PS	green	570	colorless clear	16 ... 125 40 ... 80 63 ... 125 100 ... 200 40 ... 320	– – – – –	10 10 10 10 10	24	Q62703-Q1439 Q62703-Q1868 Q62703-Q2020 Q62703-Q2021 Q62703-Q2022	

Lumineszenzdioden

Light Emitting Diodes

Radiale LED

Radial LEDs

Package	Type	Emissionsfarbe Emission color	λ_{dom} (typ.) [nm]	Gehäusefarbe Emission Color				2 ϕ (typ.) (50% I _V) [deg].	Bestellnummer Ordering code	Fig.
					I _V [mcd]	Φ_V [mlm]	at I _F [mA]			

Hyper 5 mm LED

Hyper 5 mm LEDs

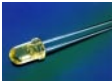
	LS 5426	super-red	632	red clear	≥ 630 (1200 typ.)	–	20	16	Q62703-Q4780	7
	LO 5426	orange	605	orange clear	≥ 630 (1500 typ.)	–	20	16	Q62703-Q4781	
	LY 5426	yellow	587	yellow clear	≥ 630 (1500 typ.)	–	20	16	Q62703-Q4782	
	LA 5416	amber	615	colorless clear	≥ 630 (1500 typ.)	–	20	16	Q62703-Q4783	
BLUE LINE™	LB 5416 LB 5416-P LB 5416-Q LB 5416-R	blue	466	colorless clear	40 ... 80 63 ... 125 100 ... 200	–	10 10 10	24	Q62703-Q4256	
	LS 5436-SO	super-red	632	colorless clear	≥ 160 (350 typ.)	–	20	30	Q62703-Q3626	
	LA 5436-TO	amber	615	colorless clear	≥ 250 (500 typ.)	–	20	30	Q62703-Q3919	
	LO 5436-TO	orange	605	colorless clear	≥ 250 (500 typ.)	–	20	30	Q62703-Q3628	
	LY 5436-TO	yellow	587	colorless clear	≥ 250 (500 typ.)	–	20	30	Q62703-Q3630	
BLUE LINE™	LB 5436 LB 5436-N LB 5436-P LB 5436-Q	blue	466	colorless clear	25 ... 50 40 ... 80 63 ... 125	–	10 10 10	70	Q62703-Q4028	

5 mm LED

5 mm LEDs

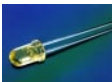

	LR 5360-DG LR 5360-F LR 5360-G LR 5360-FJ	red	645	red diffused	0.4 ... 3.2 1 ... 2 1.6 ... 3.2 1 ... 8	– – – –	10 10 10 10	50	Q62703-Q1376 Q62703-Q1377 Q62703-Q1378 Q62703-Q1379	3
	LS 5360-HL LS 5360-J LS 5360-K LS 5360-L LS 5360-JM	super-red	628	red diffused	2.5 ... 20 4 ... 8 6.3 ... 12.5 10 ... 20 4 ... 32	– – – – –	10 10 10 10 10	50	Q62703-Q1380 Q62703-Q1744 Q62703-Q1381 Q62703-Q1382 Q62703-Q3224	
	LY 5360-HL LY 5360-J LY 5360-K LY 5360-L LY 5360-JM	yellow	590	yellow diffused	2.5 ... 20 4 ... 8 6.3 ... 12.5 10 ... 20 4 ... 32	– – – – –	10 10 10 10 10	50	Q62703-Q2000 Q62703-Q1386 Q62703-Q2001 Q62702-Q2404 Q62703-Q1387	
	LG 5360-GK LG 5360-H LG 5360-J LG 5360-K LG 5360-HL	green	570	green diffused	1.6 ... 12.5 2.5 ... 5 4 ... 8 6.3 ... 12.5 2.5 ... 20	– – – – –	10 10 10 10 10	50	Q62703-Q1391 Q62703-Q1390 Q62703-Q1866 Q62703-Q2012 Q62703-Q3188	

Lumineszenzdioden

Light Emitting Diodes

Radiale LED

Radial LEDs

Package	Type	Emissionsfarbe Emission color	λ_{dom} (typ.) [nm]	Gehäusefarbe Emission Color	at			2 ϕ (typ.) (50% I _V) [deg].	Bestellnummer Ordering code	Fig.	
					I _V [mcd]	Φ_V [mlm]	I _F [mA]				
5 mm LED (Forts.)											
	LR 5460-DG LR 5460-F LR 5460-G LR 5460-FJ	red	660	red diffused	0.4 ... 3.2 1 ... 2 1.6 ... 3.2 1 ... 8	— — — —	10 10 10 10	50	Q62703-Q1392 Q62703-Q1393 Q62703-Q1394 Q62703-Q1395	7	
	LH 5464-MQ LH 5464-N LH 5464-P LH 5464-Q LH 5464-NR	hyper-red	645	red diffused	10 ... 125 25 ... 50 40 ... 80 63 ... 125 25 ... 200	— — — — —	10 10 10 10 10	35	Q62703-Q3829 Q62703-Q3830 Q62703-Q2753 Q62703-Q3831 Q62703-Q3832		
	LS 5460-HL LS 5460-J LS 5460-K LS 5460-L LS 5460-JM	super-red	628	red diffused	2.5 ... 20 4 ... 8 6.3 ... 12.5 10 ... 20 4 ... 32	— — — — —	10 10 10 10 10	50	Q62703-Q1396 Q62703-Q1746 Q62703-Q1397 Q62703-Q1398 Q62703-Q3225		
	LY 5460-HL LY 5460-J LY 5460-K LY 5460-L LY 5460-JM	yellow	590	yellow diffused	2.5 ... 20 4 ... 8 6.3 ... 12.5 10 ... 20 4 ... 32	— — — — —	10 10 10 10 10	50	Q62703-Q1400 Q62703-Q1401 Q62703-Q1402 Q62703-Q2403 Q62703-Q1403		
	LG 5460-GK LG 5460-H LG 5460-J LG 5460-K LG 5460-HL	green	570	green diffused	1.6 ... 12.5 2.5 ... 5 4 ... 8 6.3 ... 12.5 2.5 ... 20	— — — — —	10 10 10 10 10	50	Q62703-Q1407 Q62703-Q1406 Q62703-Q1867 Q62703-Q2014 Q62703-Q3190		
	LR 5480-CF LR 5480-E LR 5480-F LR 5480-DG	red	645	red diffused	0.25 ... 2.0 0.63 ... 1.25 1 ... 2 0.4 ... 3.2	— — — —	10 10 10 10	80	Q62703-Q1986 Q62703-Q1734 Q62703-Q1987 Q62703-Q1408		
	LS 5480-GL LS 5480-J LS 5480-K LS 5480-L LS 5480-JM	super-red	628	red diffused	1.6 ... 20 4 ... 8 6.3 ... 12.5 10 ... 20 4 ... 32	— — — — —	10 10 10 10 10	80	Q62703-Q1989 Q62703-Q1414 Q62703-Q1990 Q62703-Q1991 Q62703-Q1992		
	LY 5480-HL LY 5480-J LY 5480-K LY 5480-L LY 5480-JM	yellow	590	yellow diffused	2.5 ... 20 4 ... 8 6.3 ... 12.5 10 ... 20 4 ... 32	— — — — —	10 10 10 10 10	80	Q62703-Q1416 Q62703-Q3236 Q62703-Q1418 Q62703-Q2402 Q62703-Q1419		
	LG 5480-GK LG 5480-H LG 5480-J LG 5480-K LG 5480-HL	green	570	green diffused	1.6 ... 12.5 2.5 ... 5 4 ... 8 6.3 ... 12.5 2.5 ... 20	— — — — —	10 10 10 10 10	80	Q62703-Q1423 Q62703-Q1422 Q62703-Q1869 Q62703-Q2018 Q62703-Q3191		
5 mm LEDs (cont'd)											
	LS 5380-FJ LS 5380-G LS 5380-H LS 5380-J LS 5380-HL	super-red	628	red diffused	1 ... 8 1.6 ... 3.2 2.5 ... 5 4 ... 8 2.5 ... 20	— — — — —	10 10 10 10 10	140	Q62703-Q1452 Q62703-Q1740 Q62703-Q1453 Q62703-Q1454 Q62703-Q1455		10
	LY 5380-GK LY 5380-H LY 5380-J LY 5380-K LY 5380-HL	yellow	590	yellow	1.6 ... 12.5 2.5 ... 5 4 ... 8 6.3 ... 12.5 2.5 ... 20	— — — — —	10 10 10 10 10	140	Q62703-Q2002 Q62703-Q1457 Q62703-Q2319 Q62703-Q3909 Q62703-Q2003		
	LG 5380-GK LG 5380-H LG 5380-J LG 5380-K LG 5380-HL	green	570	green diffused	1.6 ... 12.5 2.5 ... 5 4 ... 8 6.3 ... 12.5 2.5 ... 20	— — — — —	10 10 10 10 10	140	Q62703-Q1463 Q62703-Q2032 Q62703-Q2016 Q62703-Q3189 Q62703-Q3825		

■ Nicht für Neuentwicklungen/Not for new design

Lumineszenzdioden

Light Emitting Diodes

Radiale LED

Radial LEDs

Package	Type	Emissionsfarbe Emission color	λ_{dom} (typ.) [nm]	Gehäusefarbe Emission Color	at			2 ϕ (typ.) (50% I _V) [deg].	Bestellnummer Ordering code	Fig.
					I _V [mcd]	Φ_V [mlm]	I _F [mA]			

LC 5 mm LED (Niedrigstrom)

LC 5 mm LEDs (Low Current)

	LS 5469-EH LS 5469-G LS 5469-H LS 5469-GK	super-red	628	red diffused	0.63 ... 5.0 1.60 ... 3.2 2.50 ... 5.0 1.60 ... 12.5	– – – –	2 2 2 2	50	Q62703-Q1751 Q62703-Q2344 Q62703-Q2345 Q62703-Q3833	7
	LY 5469-EH LY 5469-F LY 5469-G LY 5469-H LY 5469-FJ	yellow	590	yellow diffused	0.63 ... 5.0 1.00 ... 2.0 1.60 ... 3.2 2.50 ... 5.0 1.00 ... 8.0	– – – – –	2 2 2 2 2	50	Q62703-Q1752 Q62703-Q3834 Q62703-Q3835 Q62703-Q3836 Q62703-Q3837	
	LG 5469-EH LG 5469-F LG 5469-G LG 5469-FJ	green	570	green diffused	0.63 ... 5.0 1.00 ... 2.0 1.60 ... 3.2 1.00 ... 8.0	– – – –	2 2 2 2	50	Q62703-Q1753 Q62703-Q3856 Q62703-Q3857 Q62703-Q3858	

5 mm MULTILED® (2.54 mm Raster)

5 mm MULTILED® (2.54 mm Spacing)

	LU 5351-GL	super-red/ green	628/ 570	colorless clear	1.6 ... 20	–	10	50	Q62703-Q2046	11
	LU 5351-JM	super-red/ green	628/ 570	partly diffused	4 ... 32	–	10	50	Q62703-Q2047	

ARGUS® LED

ARGUS® LEDs

	LS K380-LP LS K380-N LS K380-P LS K380-Q LS K380-NR	super-red	628	red clear	– – – – –	10 ... 80 25 ... 50 40 ... 80 63 ... 125 25 ... 200	15 15 15 15 15	– – – – –	Q62703-Q1768 Q62703-Q0760 Q62703-Q1003 Q62703-Q1004 Q62703-Q2223	32
	LO K380-LP LO K380-N LO K380-P LO K380-Q LO K380-NR	orange	605	orange clear	– – – – –	16 ... 125 25 ... 50 40 ... 80 63 ... 125 25 ... 200	15 15 15 15 15	– – – – –	Q62703-Q1888 Q62703-Q2227 Q62703-Q2228 Q62703-Q2229 Q62703-Q2201	
	LY K380-LP LY K380-N LY K380-P LY K380-Q LY K380-NR	yellow	590	yellow clear	– – – – –	16 ... 125 25 ... 50 40 ... 80 63 ... 125 25 ... 200	15 15 15 15 15	– – – – –	Q62703-Q1769 Q62703-Q0575 Q62703-Q0576 Q62703-Q3844 Q62703-Q2224	
	LG K380-LP LG K380-N LG K380-P LG K380-Q LG K380-NR	green	570	green clear	– – – – –	10 ... 80 25 ... 50 40 ... 80 63 ... 125 25 ... 200	15 15 15 15 15	– – – – –	Q62703-Q1770 Q62703-Q0759 Q62703-Q1034 Q62703-Q3193 Q62703-Q2225	
	LP K380-KN LP K380-L LP K380-M LP K380-N LP K380-LP	pure green	560	green clear	– – – – –	6.3 ... 50 10 ... 20 16 ... 32 25 ... 50 10 ... 80	15 15 15 15 15	– – – – –	Q62703-Q2506 Q62703-Q3215 Q62703-Q2610 Q62703-Q2605 Q62703-Q3217	

Lumineszenzdiode

Light Emitting Diodes

Radiale LED

Radial LEDs

Package	Type	Emissionsfarbe Emission color	λ_{dom} (typ.) [nm]	Gehäusefarbe Emission Color	at			2 ϕ (typ.) (50% I _V) [deg].	Bestellnummer Ordering code	Fig.
					I _V [mcd]	Φ_V [mlm]	I _F [mA]			

Super ARGUS® LED

Super ARGUS® LEDs

	LS K382-QT LS K382-R LS K382-S LS K382-RU	super-red	628	red clear	– – – –	63 ... 500 100 ... 200 160 ... 320 100 ... 800	50 50 50 50	–	Q62703-Q2633 Q62703-Q2634 Q62703-Q2635 Q62703-Q1956	31
	LO K382-QT LO K382-R LO K382-S LO K382-RU	orange	605	orange clear	– – – –	63 ... 500 100 ... 200 160 ... 320 100 ... 800	50 50 50 50	–	Q62703-Q2636 Q62703-Q2637 Q62703-Q2638 Q62703-Q1957	
	LY K382-QT LY K382-R LY K382-S LY K382-RU	yellow	590	yellow clear	– – – –	63 ... 500 100 ... 200 160 ... 320 100 ... 800	50 50 50 50	–	Q62703-Q2639 Q62703-Q2640 Q62703-Q2641 Q62703-Q1958	
	LG K382-QT LG K382-R LG K382-S LG K382-T LG K382-RU	green	570	green clear	– – – – –	63 ... 500 100 ... 200 160 ... 320 250 ... 500 100 ... 800	50 50 50 50 50	–	Q62703-Q2642 Q62703-Q2643 Q62703-Q2644 Q62703-Q2645 Q62703-Q1959	
	LP K382-NR LP K382-P LP K382-Q LP K382-R LP K382-PS	pure green	560	colorless clear	– – – – –	25 ... 200 40 ... 80 63 ... 125 100 ... 200 40 ... 320	50 50 50 50 50	–	Q62703-Q2646 Q62703-Q2339 Q62703-Q2338 Q62703-Q2337 Q62703-Q2123	

Hyper ARGUS® 3 mm LED

Hyper ARGUS® 3 mm LEDs

	LH K376-QS LH K376-R LH K376-S LH K376-RT	hyper-red	645	colorless clear	– – – –	63 ... 200 100 ... 200 160 ... 320 100 ... 500	20 20 20 20	–	Q62703-Q3492 Q62703-Q3304 Q62703-Q3305 Q62703-Q3493	12
	LS K376-QT LS K376-R LS K376-S LS K376-T LS K376-RU	super-red	632	colorless clear	– – – – –	63 ... 500 100 ... 200 160 ... 320 250 ... 500 100 ... 800	20 20 20 20 20	–	Q62703-Q3467 Q62703-Q3468 Q62703-Q3469 Q62703-Q3470 Q62703-Q3471	
	LA K376-RU LA K376-S LA K376-T LA K376-U LA K376-SV	amber	615	colorless clear	– – – – –	100 ... 800 160 ... 320 250 ... 500 400 ... 800 160 ... 1250	20 20 20 20 20	–	Q62703-Q3735 Q62703-Q3737 Q62703-Q3738 Q62703-Q3739 Q62703-Q3736	
	LO K376-RU LO K376-S LO K376-T LO K376-U LO K376-SV	orange	605	colorless clear	– – – – –	100 ... 800 160 ... 320 250 ... 500 400 ... 800 160 ... 1250	20 20 20 20 20	–	Q62703-Q3472 Q62703-Q3473 Q62703-Q3474 Q62703-Q3475 Q62703-Q3476	
	LY K376-RU LY K376-S LY K376-T LY K376-U LY K376-SV	yellow	587	colorless clear	– – – – –	100 ... 800 160 ... 320 250 ... 500 400 ... 800 160 ... 1250	20 20 20 20 20	–	Q62703-Q3477 Q62703-Q3478 Q62703-Q3479 Q62703-Q3480 Q62703-Q3481	
	BLUE LINE™ LB K376 LB K376-L1 LB K376-L2 LB K376-M1 LB K376-M2 LB K376-N1	blue	466	colorless clear	– – – – – –	10.0 ... 16.0 12.5 ... 20.0 16.0 ... 25.0 20.0 ... 32.0 25.0 ... 40.0	10 10 10 10 10	–	Q62703-Q4069	

■ Nicht für Neuentwicklungen/Not for new design

Lumineszenzdioden

Light Emitting Diodes

Radiale LED

Radial LEDs

Package	Type	Emissionsfarbe Emission color	λ_{dom} (typ.) [nm]	Gehäusefarbe Emission Color	at			2 ϕ (typ.) (50% I _V) [deg].	Bestellnummer Ordering code	Fig.
					I _V [mcd]	Φ_V [mlm]	I _F [mA]			

LC ARGUS® LED (Niedrigstrom)

LC ARGUS® LEDs (Low Current)

	LS K389-FO	super-red	628	red clear	–	5 (≥ 1)	2	–	Q62703-Q1771	12
	LY K389-FO	yellow	590	yellow clear	–	3.2 (≥ 1)	2	–	Q62703-Q1772	
	LG K389-FO	green	570	green clear	–	3.2 (≥ 1)	2	–	Q62703-Q1773	

Zeilen LED 2 mm Ø

Array LEDs 2 mm Dia

	LR Z181-CO LR Z182-CO LR Z183-CO LR Z184-CO LR Z185-CO LR Z186-CO LR Z187-CO LR Z188-CO	red	645	red diffused	≥ 0.25	–	10	100	Q62703-Q1495 Q62703-Q1496 Q62703-Q1497 Q62703-Q1498 Q62703-Q1499 Q62703-Q1500 Q62703-Q1501 Q62703-Q1502	16
	LY Z181-CO	yellow	590	yellow diffused	≥ 0.25	–	10	100	Q62703-Q1505	
	LG Z181-CO LG Z182-CO LG Z183-CO LG Z184-CO LG Z185-CO LG Z186-CO LG Z188-CO	green	570	green diffused	≥ 0.25	–	10	100	Q62703-Q1506 Q62703-Q1507 Q62703-Q1508 Q62703-Q1509 Q62703-Q1510 Q62703-Q1511 Q62703-Q1513	

Mini LED 1 mm Ø

Miniature LEDs 1 mm Dia

	LS U260-EO	super-red	628	red diffused	≥ 0.63	–	10	60	Q62703-Q1492	15
	LY U260-EO	yellow	590	yellow diffused	≥ 0.63	–	10	60	Q62703-Q1493	
	LG U260-EO	green	570	colorless diffused	≥ 0.63	–	10	60	Q62703-Q1494	

Mini LED mit axialen Anschlüssen

Miniature LEDs, Axial-Leaded

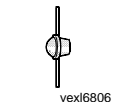
	RL 50	red	645	colorless clear	≥ 0.5	–	20	90	Q68000-A5954	17
	RL 54	red	645	red diffused	≥ 0.4	–	20	90	Q68000-A5958	
	RL 55	red	645	red diffused	≥ 2.0	–	10	50	Q68000-A5959	
	YL 56	yellow	590	yellow diffused	≥ 2.0	–	10	40	Q68000-A5961	18
	GL 56	green	570	green diffused	≥ 1.0	–	10	40	Q68000-A5962	

Maßbilder in inch (mm)

Outline drawings in inch (mm)

Figure 1 L* T670, L* T672, LH T674, L* T679, L* T676, LH T676, LG T671

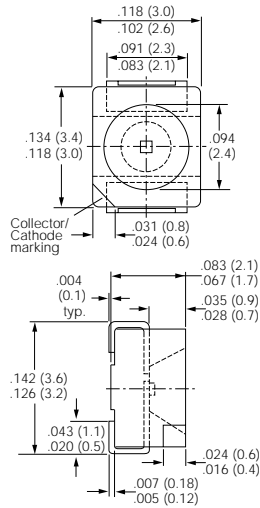

Figure 2 L** T670, L** T672, L** T671, L** T676

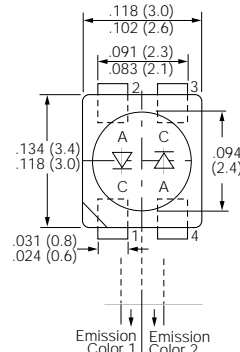

Figure 3 L* 5360

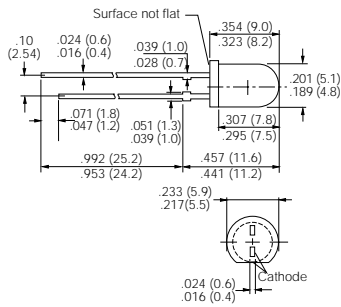

Figure 4 L* 3340, L* 3330, L* 3360, L* 3369, L* 3386, L* 3380, L* 3336, L* 3356, L* 3366

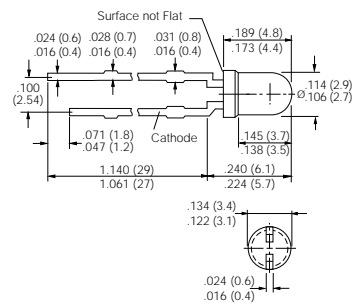

Figure 5 L* 3341, LH 3344, LH 3364

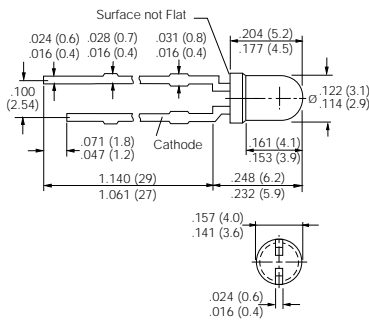
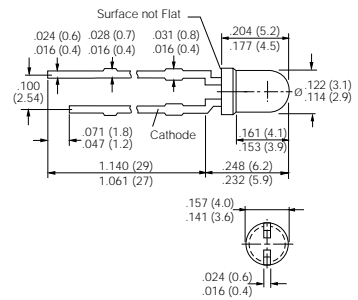

Figure 6 LSG 3331, LSG 3351



Maßbilder in inch (mm)

Outline drawings in inch (mm)

Figure 7 L* 5421, LG 5411, L* 5410, L* 5416, L* 5420, L* 5426, L* 5436, L* 5460, L* 5469, L* 5480, LH 5424, LH 5464

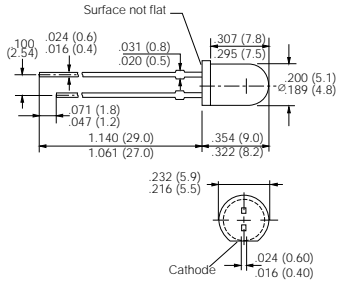

Figure 8 LSG T677

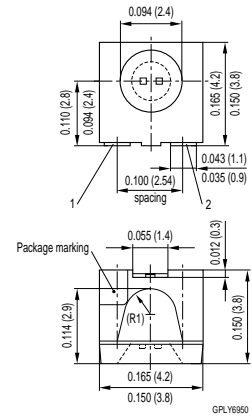

Figure 9 L* S260, LU S250, L* S269

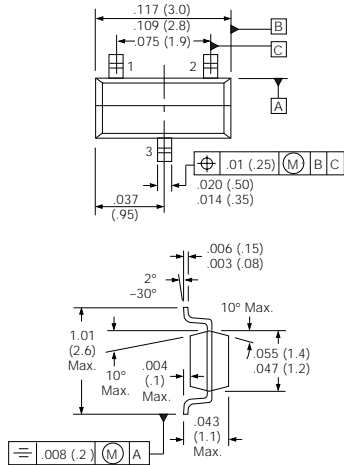

Figure 10 L* 5380

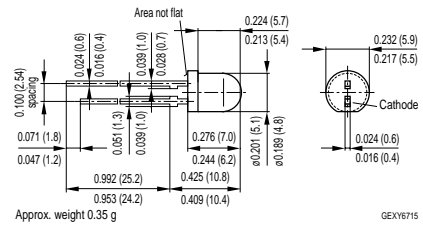

Figure 11 LU 5351

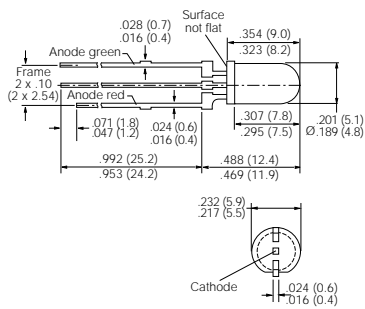
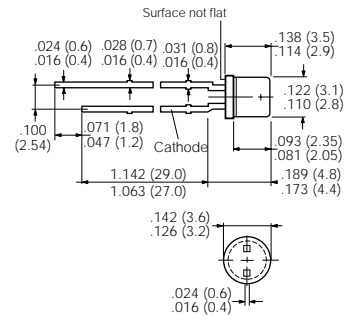

Figure 12 L* K376, L* K389



Maßbilder in inch (mm)

Outline drawings in inch (mm)

Figure 21 LSY A676, L** A671

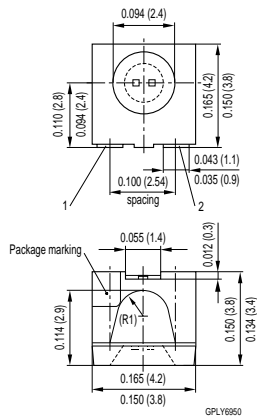

Figure 22 L* M770, L* M776, L* M779

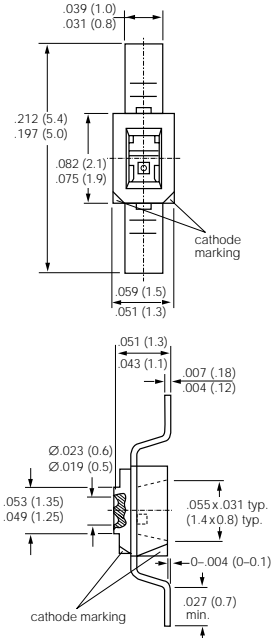

Figure 23 L* R971, L* R976

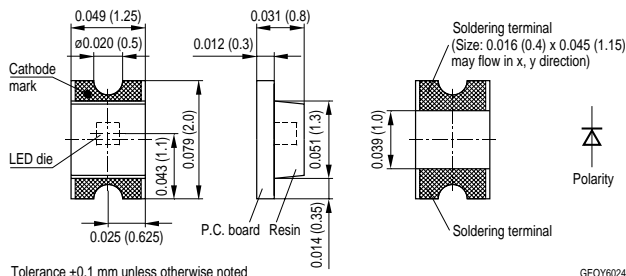

Figure 24 LH R974

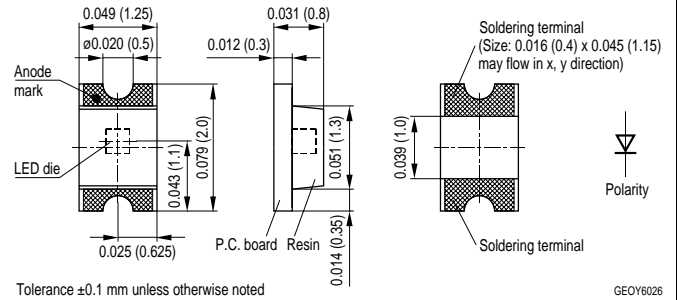

Figure 25 L* Q971, L* Q976

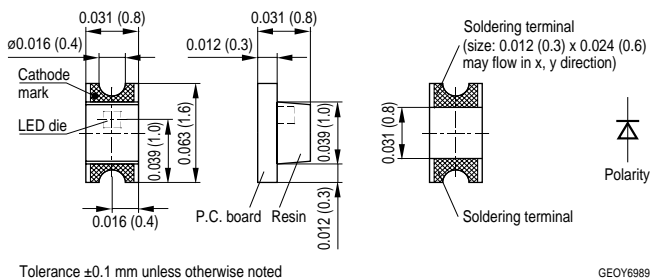
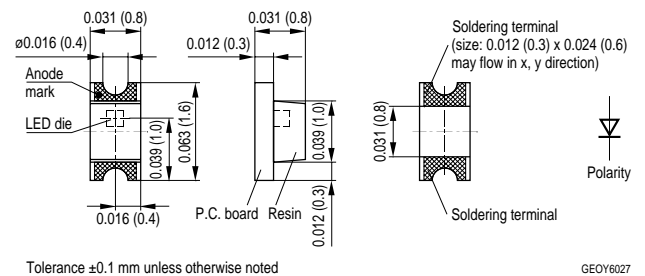

Figure 26 LH Q974



Maßbilder in inch (mm)

Outline drawings in inch (mm)

Figure 27 L* N971, LH N974

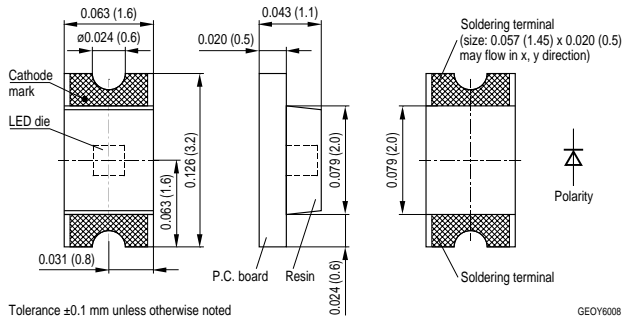

Tolerance ±0.1 mm unless otherwise noted

GEOY6008

Figure 28 LSG F971

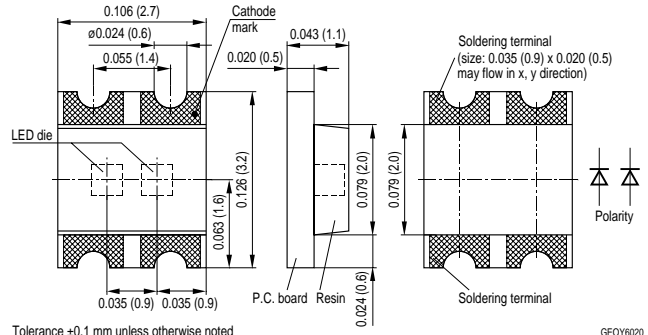

Tolerance ±0.1 mm unless otherwise noted

GEOY6020

Figure 29 LB R99A, LW R98A

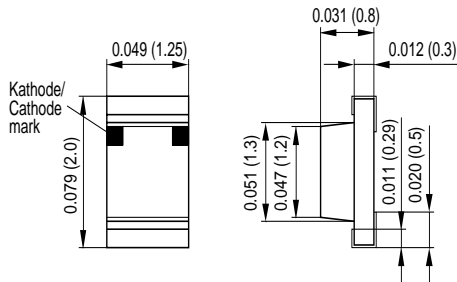

Tolerance ±0.1 mm unless otherwise noted

GEOY6987

Figure 30 LB Q99A, LW Q98A

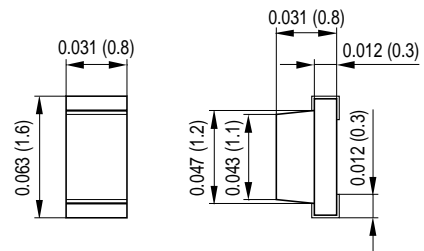

Tolerance ±0.1 mm unless otherwise noted

GEOY6023

Figure 31 L* K382

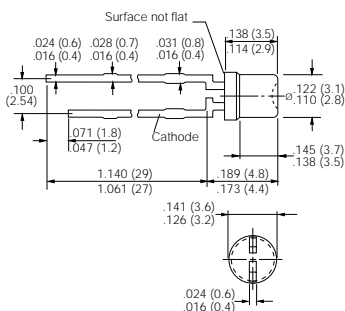
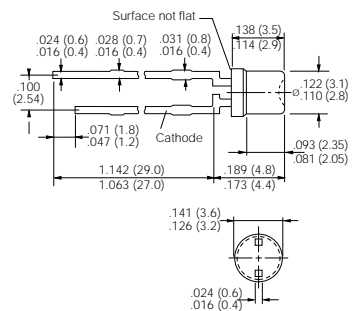

Figure 32 L* K380



Maßbilder in inch (mm)

Outline drawings in inch (mm)

Figure 33 LY E676, LA E675

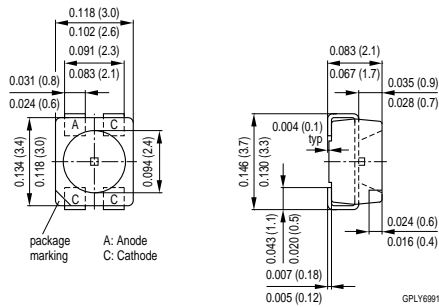
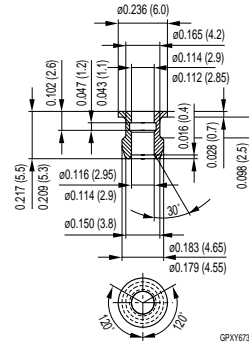
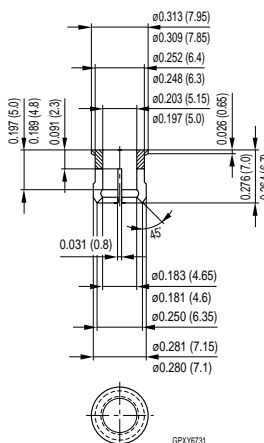

Figure 34 Hülse und Ring, 3 mm LED
Sleeves and ring, 3 mm LED:
Q62901-B61 (glass clear)
Q62901-B62 (black)



ø Bohrung/bore = 4.3-4.4 mm^{*)}
Stärke der Montageplatte = 1.0-1.5 mm^{*)}
Thickness of mounting board = 1.0-1.5 mm^{*)}

Figure 35 Hülse und Ring, 5 mm LED
Sleeves and ring, 5 mm LED:
Q62901-B64 (glass clear)
Q62901-B65 (black)



ø Bohrung/bore = 6.45-6 mm^{*)}
Stärke der Montageplatte = 1.5-2.5 mm^{*)}
Thickness of mounting board = 1.5-2.5 mm^{*)}

Figure 36 Aneinanderreihbare Halterung
für 3 mm LED
Endstackable clips for 3 mm LED
Q62902-B152-F222 (black)

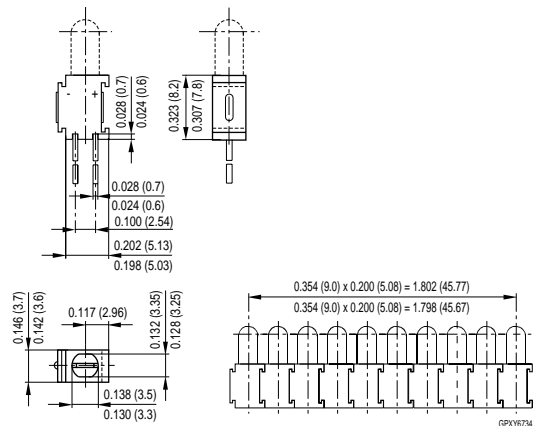

Maßbilder in inch (mm)

Outline drawings in inch (mm)

Figure 37 Aneinanderreihbare Halterung für 5 mm LED
Endstackable clips for 5 mm LED
Q62902-B153-F222 (black)

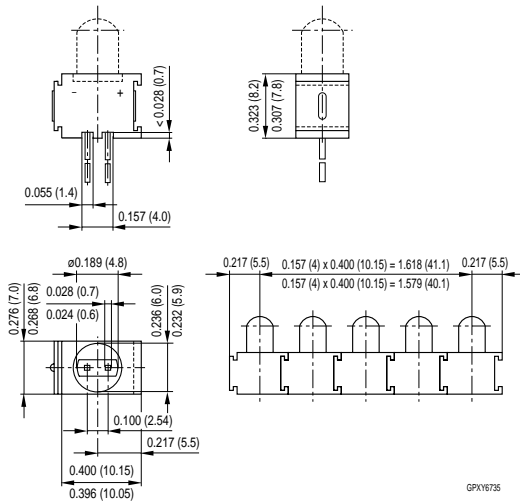

Figure 38 Winkelhalterungen für 5 mm LED
Rectangular mounting part for 5 mm LED
Q62902-B156-F222 (grey)

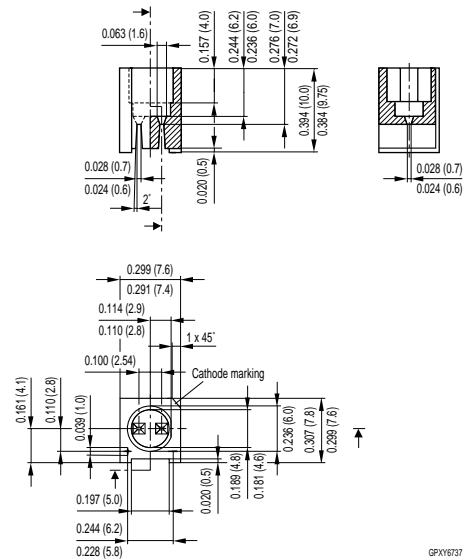

Figure 39 Winkelhalterungen für 3 mm LED
Rectangular mounting part for 3 mm LED
Q62902-B155-F222 (grey)

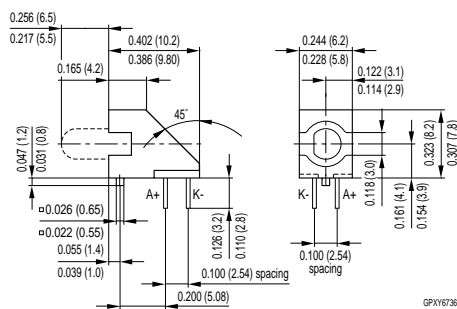

Figure 40 Reflektor für 3 mm LED
Reflector for 3 mm LED
Q62902-B141-F222 (silver)

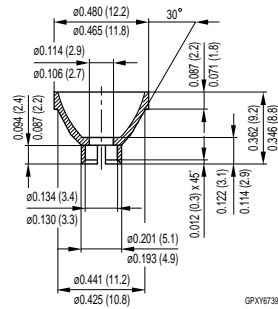

Figure 41 Reflektor für 5 mm LED
Reflector for 5 mm LED
Q62902-B154-F222 (silver)

