

RETICON®

LC3000-Series

High Performance, Low-Cost Analog Line Scan Camera

512, 1024 and 2048 elements, 10 and 20 MHz output rates



Description

In the LC3000-series analog line scan camera, PerkinElmer has combined the best features of photodiode array detection, high-speed charge-coupled scanning, and analog line scan camera technology to offer an uncompromising solution to the increasing demands of advanced imaging applications.

The LC3000-series is a high performance, low-cost, analog line scan camera line. The LC3000-series features a differential driver analog video output with resolutions of 512, 1024 or 2048 pixels, which can achieve data rates of up to 20 MHz with exceptional noise immunity. They are designed for volume applications where small size and low cost are required.

In order to allow the user to compensate for variations in illumination found in "real-world" application environments, the cameras feature adjustable gain and offset levels. The LC3000-series cameras feature a

geometrically precise photodiode CCD image sensor with 14 μ m square photo-elements. State of the art electronic design enables the LC3000-series to deliver consistent, reliable performance while the sturdy metal housing provides maximum protection in a variety of harsh environment and factory floor conditions.

The LC3000-series cameras convert light imaged during a scene into an analog video signal. The amplitude of the video signal is a linear function of the incident illumination taken from the scene. Antiblooming structures within the sensor ensure superior performance over a wide range of lighting conditions. User-defined control is possible for line rate, integration time and video data rate.

LC3000 cameras may be interfaced to most frame grabber cards, allowing for a tested, plug and play solution. Typical high performance line scan

Features

- 10 and 20 MHz output rate models
- Geometrically precise 14 μ m square pixel CCD
- Small size: 2.5"H x 2.5"W x 2.72"L
- High dynamic range (500:1)
- Peak QE greater than 65%
- Antiblooming control
- Single power supply operation
- Electronic exposure control
- Adjustable gain and offset levels
- Line scan rates to 36 kHz



Analog Line Scan Camera

Description (cont.)

applications include lumber processing, parcel scanning, non-contact measurement, document scanning, dimensional gauging, biomedical imaging, bar code scanning and many other industrial and scientific applications.

The Sensor

The LC3000-series cameras contain a high-performance, high-resolution line scan image sensor (PerkinElmer Optoelectronics parts RL0512PAG, RL1024PAG, or RL2048PAG) featuring a pinned photodiode pixel. Each photodiode converts incident light into discrete charge packets. Advantages of pinned photodiode pixels include linear exposure control, the elimination of image lag, and the reduction of photo response non-uniformity (PRNU). For more specific sensor specifications and information, please consult the appropriate sensor datasheet. Figure 1a details the spectral sensitivity of the sensor, while Figure 1b details the sensor's glass window light transmission curve.

Functional Description

The video signal from the sensor is processed through a single channel of sampled-and-held, raster order, analog video data. The video channel signal processing circuitry offers both adjustable gain and offset levels to allow customization of the camera to unique lighting applications. An operational amplifier in a differential configuration is recommended to receive the video signal. Figure 2 details the camera video processing.

Operating Modes

The LC3000-series cameras can be operated in one of two different modes: Master Mode and Slave Mode. Master mode is to be used when the LC3000-series camera is operating as a stand-alone unit. Master mode requires only input DC power (12-24 VDC) for operation. In this mode of operation, the camera will operate at its basic clock frequency (defined by the model number) and at the maximum line rate. Master mode operation is selected using the bank of rear-camera located

Figure 1a: Spectral Sensitivity Curve (Min. Gain)

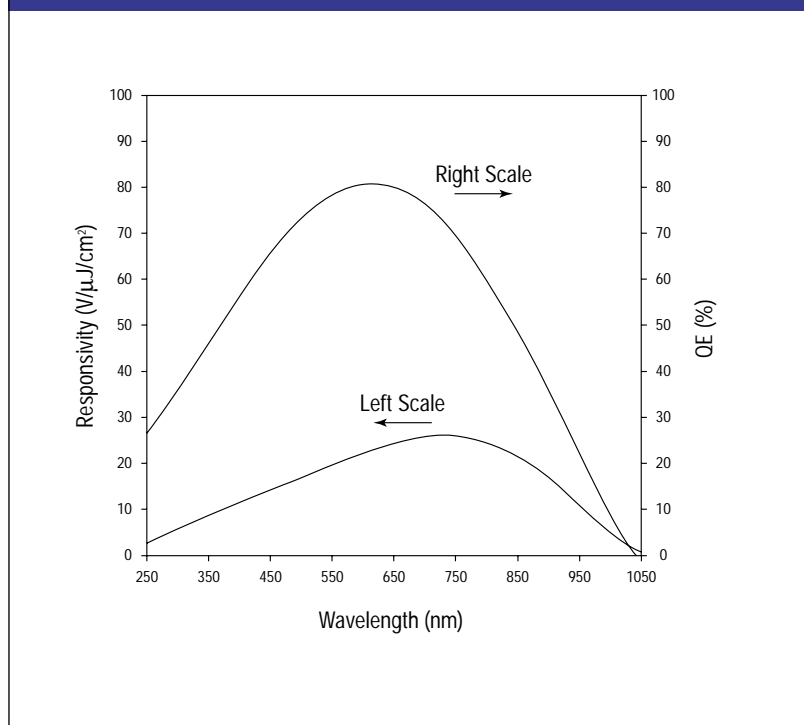

Figure 1b: Sensor Window Transmission Curve

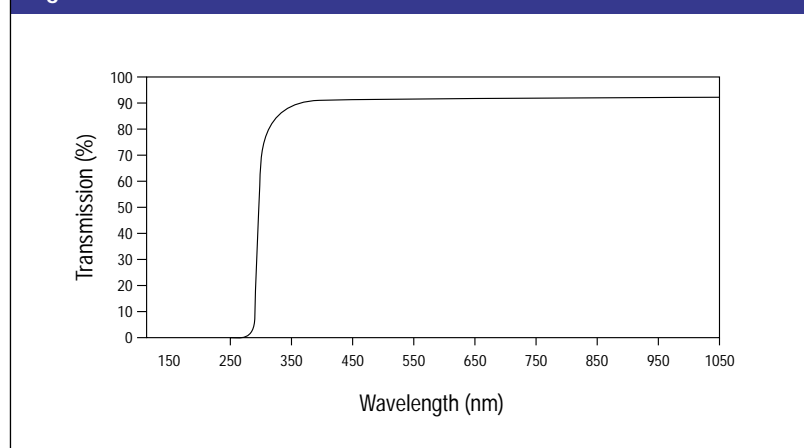
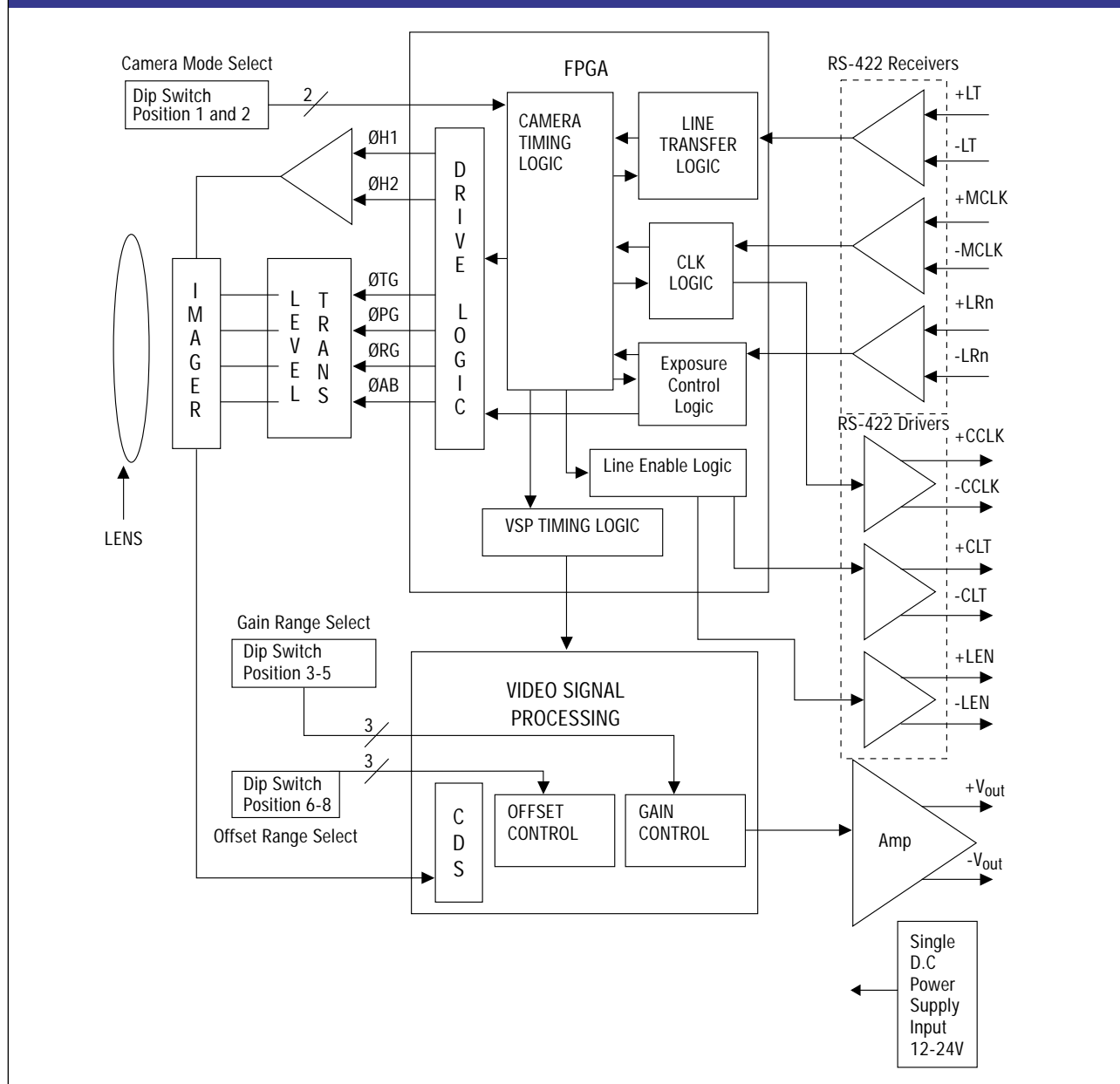

Table 1. Master/Slave Mode DIP-switch Settings

DIP Switch #1 Setting	DIP Switch #2 Setting	Operating Mode
ON	ON	Master Mode
OFF	OFF	Slave Mode
OFF	ON	Alternate Slave 1
ON	OFF	Alternate Slave 2

Analog Line Scan Camera

Figure 2: LC3000 Camera Block Diagram



DIP-switches. These switches are accessible behind a removable panel, located above the 25-pin connector on the back plate of the camera. Figure 3 illustrates the timing details in Master Mode.

Slave Mode is to be selected when the camera's operations are to be synchronized with the user's unique system. In slave mode, the camera requires an external Master Clock signal (MLCK)

to define the output video data rate, as well as a properly timed Line Transfer (LT) signal to initiate the line readout. Figure 4 illustrates timing details in slave mode. Table 1 details correct DIP-switch settings for both Master and Slave Mode.

Within slave mode, there are two alternative settings for unique applications. Alternative Slave Mode 1 allows the user to supply the camera

with Line Reset (LR) and LT signals, but allows the camera to run at the maximum data rate determined by the internal oscillator. Alternative Slave Mode 2 instructs the camera to ignore LR signals, which allows users to bypass the exposure control feature of the camera. Table 1 details all DIP-switch settings for all operating modes.

Analog Line Scan Camera

Figure 3: Master Mode Timing Diagram

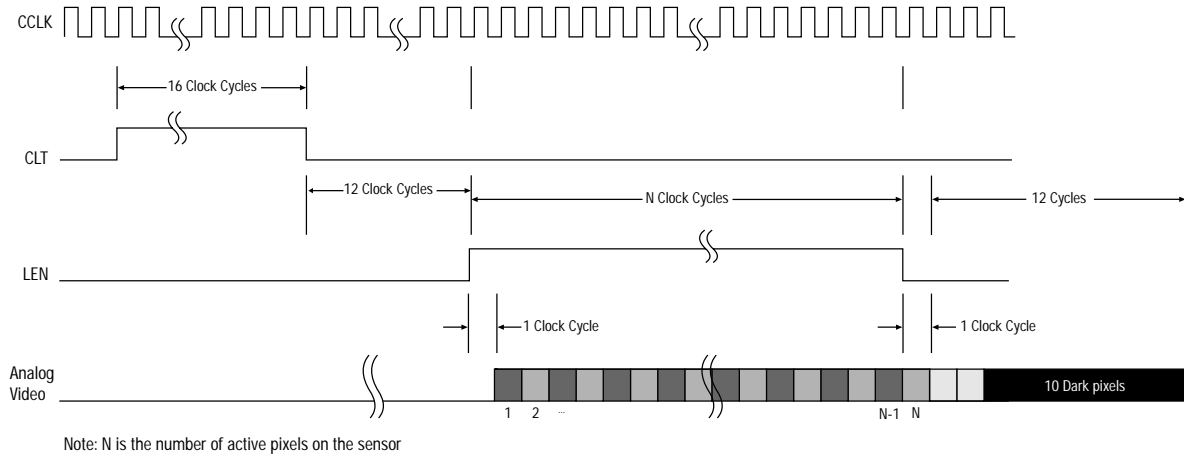
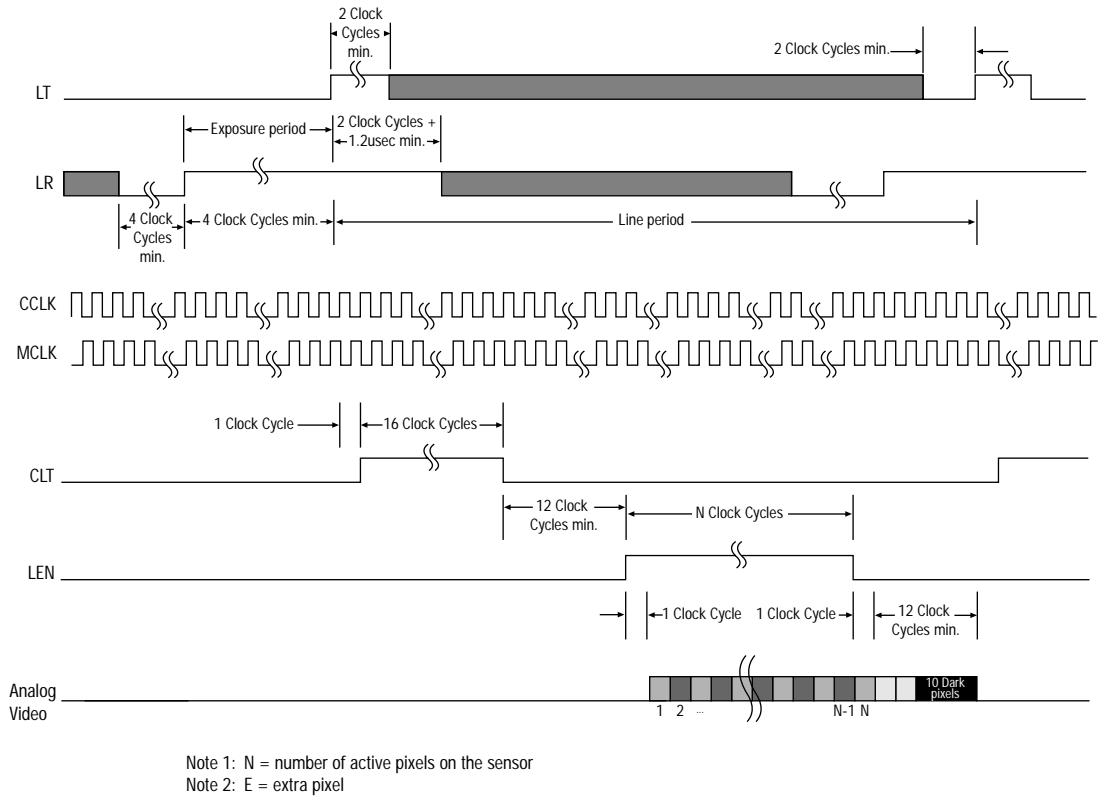

Figure 4: Slave Mode Timing Diagram



Analog Line Scan Camera

Input Signals

The LC3000 camera requires a single DC supply (+12 to 24VDC) for operation. An internal oscillator sets the default data output rate to default model rate (10 or 20 MHz), and the camera will operate at the maximum line rate. The camera can be further controlled by three externally generated differential input signals: Master Clock (MCLK), Line Transfer (LT), and Line Reset (LR).

The Master Clock input determines the data rate frequency for values up to maximum clock of the camera. The MCLK input is optional, as the camera is preset to run off of the internal oscillator at the default maximum data rate. Should a data rate slower than that default rate be necessary, an externally supplied master clock can be enabled by selecting that setting through the bank of DIP-switches. The data rate may be run from 20 kHz to cameras maximum clock rate. External line transfer operation also can be enabled on the DIP-switch bank.

The Line Transfer input signal transfers the charge from each photo site to the readout registers. The readout registers, in turn, transport the charge from each photodiode in succession to the video outputs. The LT input from the user must remain in the ON state for at least two MCLK cycles to initiate the internal line transfer and may remain ON until 2 clock cycles prior to the next desired line transfer. Because there are extra stages in the CCD sensors readout register, a minimum number of MCLK cycles (the number of elements on the CCD sensor plus 41) must exist between successive LT commands.

The maximum line scan period without exposure control is 20 milliseconds. Integration times longer than 20 ms can introduce higher levels of dark current, which reduces the dynamic range of the sensor. Longer integration times are possible, however, if the camera is cooled, which reduces dark current. Specific application characteristics, such as light level and rate of object motion, will determine the optimum setting. Exposure time of the

camera can be separately controlled by using the external line reset input. The LR input is active low (ON) in polarity and therefore, when not in use, must be held high (OFF). In this condition, the exposure time is defined by the period of the LT signal. When using the LR input signal, the exposure period is defined to be the time between the rising edge of LR to the rising edge of LT. The LR signal must be held active low (ON) for a minimum of 4 clock cycles and must be inactive high (OFF) for a minimum of 4 clock cycles prior to the LT signal.

Output Signals

The LC3000-series camera provides three output synchronization signals: Camera Clock (CCLK), Line Enable (LEN), and Camera Line Transfer (CLT).

The Camera Clock (CCLK) operates at either the MCLK frequency or default camera frequency, and is synchronized to the analog video. The output

of the CCLK signal can be used to capture analog video data by a frame grabber or digitizer.

The Line Enable (LEN) signal brackets the valid analog video. The signal becomes high one CCLK period before the first valid pixel and goes low one CCLK period before the last valid pixel. The video output is a contiguous pixel data stream with a dynamic range (defined as peak video divided by rms. pixel noise) of greater than 500:1.

The Camera Line Transfer (CLT) output signal is an internally generated sync signal. Its falling edge indicates the start of a line readout sequence. This signal may be used for controlling strobes, shutters or other accessories of the users system.

Table 2. Video Offset Switch Settings

Range	DIP Switch #6	DIP Switch #7	DIP Switch #8	Normal Offset (mV)
0	ON	ON	ON	0
1	ON	ON	OFF	6.4
2	ON	OFF	ON	12.8
3	ON	OFF	OFF	19.3
4	OFF	ON	ON	25.7
5	OFF	ON	OFF	32.1
6	OFF	OFF	ON	38.6
7	OFF	OFF	OFF	45.0

Table 3. Video Gain Switch Settings

Range	DIP Switch #3	DIP Switch #4	DIP Switch #5	Gain Times Full Scale
0	ON	ON	ON	0.67
1	ON	ON	OFF	1.00
2	ON	OFF	ON	1.50
3	ON	OFF	OFF	2.20
4	OFF	ON	ON	3.35
5	OFF	ON	OFF	5.00
6	OFF	OFF	ON	7.50
7	OFF	OFF	OFF	11.20

Analog Line Scan Camera

Video Signals

The LC3000-series camera features an adjustable DC offset. This offset is controlled by the bank of DIP-switches. Table 2 describes the nominal level of the video black level with respect to the various switch selections.

Additionally, the LC3000-series cameras feature a user-adjustable video gain. Video gain is adjustable by the bank of DIP-switches. Table 3 references the various settings and corresponding gain levels. Cameras are shipped factory-default with range 1.



Table 4. Camera Features Summary

Model	Array	Active Pixels	Pixel Size	Maximum Data Rate	Max. Line Scan Rate	Max. Line Scan Period
LC3011	RL0512P	512	14µm x 14µm	10 MHz	18,000 L/Sec	55.3µs
LC3012	RL1024P	1024	14µm x 14µm	10 MHz	9,300 L/Sec	106.5µs
LC3013	RL2048P	2048	14µm x 14µm	10 MHz	4,700 L/Sec	208.9µs
LC3021	RL0512P	512	14µm x 14µm	20 MHz	36,000 L/Sec	27.7µs
LC3022	RL1024P	1024	14µm x 14µm	20 MHz	18,700 L/Sec	53.3µs
LC3023	RL2048P	2048	14µm x 14µm	20 MHz	9,500 L/Sec	104.5µs

Figure 5. Optical Interface Diagram

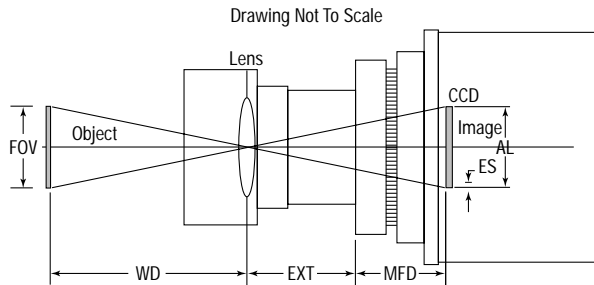

- FOV = Field of view (object size + tolerance)
- RR = Resolution requirement = FOV / RR
- ER = Elements required (calculated)
- EN = # of CCD elements
- ES = Element size (pixel spacing) - 14µm
- AL = Array length (max. image size) = EN x ES
- MAC = Magnification = AL / FOV
- WD = Working distance (object to lens)
- EXT = Length of extensions = WD / MAG
- MFD = Mount to flange distance

Figure 6. LC3000 Outline Drawings

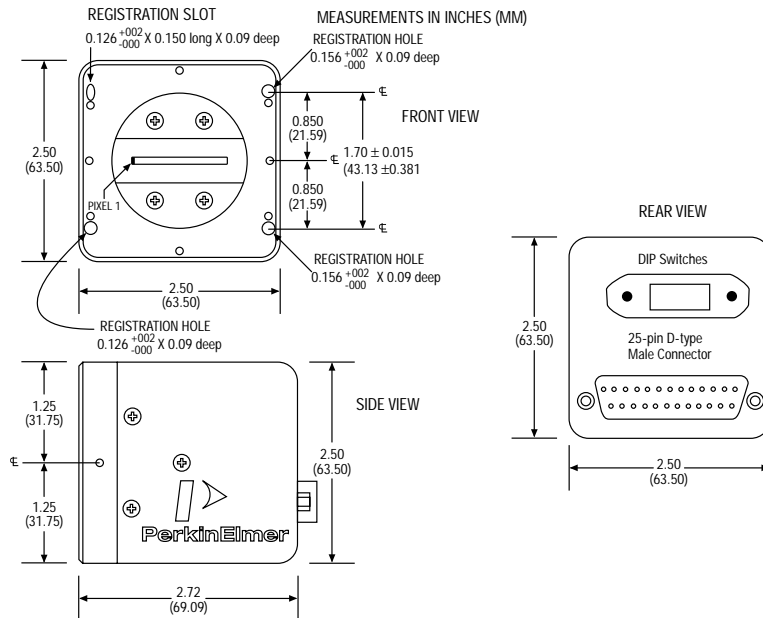

Analog Line Scan Camera

User Connections

The connector on the LC3000-series camera is a 25-pin D-type male connector. All user connections are via this connector. It contains all communications, output, and power connections needed for camera operation. Refer to Table 5 for pinout locations and details.

Camera Performance

The camera head is housed in a rugged, one-piece, deep drawn aluminum case, measuring 2.5"H x 2.5"W x 2.72"L (excluding lens mounts or connector extensions) specifically designed for industrial applications. The sensor is mounted on an aluminum plate that efficiently transfers heat to the camera case. The camera is provided with a standard ¼"-20 UNC tripod mounting block, which can be attached to any of the four sides of the camera. The mounting holes used to attach the tripod block can also be used to mount the camera assembly. The recommended mounting method for the LC3000-series is attaching the camera to the desired location using the faceplate of the housing. The faceplate mounting screws should have a maximum insertion depth of 0.25" (6.35 mm). This mounting method results in the most advantageous use of the one-piece faceplate design and provides a highly stable reference surface to the optical plane of the CCD sensor. Additionally, the CCD sensor is thermally coupled to the faceplate of the camera, and the conductive cooling of this surface is useful in minimizing thermally generated dark current and noise of the camera system.

Optical Interface

The LC3000-series cameras are equipped with a U-Mount lens interface (MA2-1-6H) that is aligned to the CCD sensor. Adapters are available to accept 'C', 'U', or 'F' (Nikon Bayonet) lens. These standard adapters allow the user to select the optimum lens to suit their particular application. For assistance in choosing camera adapters, extensions, and lenses, contact PerkinElmer.

Table 5. Pin Assignments

Pin	Signal	Description	Pin	Signal	Description
1	N/C	No Connection	14	Power Return	Input Power Common
2	N/C	No Connection	15	MCLK+	Master Clock+
3	CCLK+	Camera Clock+	16	CCLK-	Camera Clock-
4	MCLK-	Master Clock-	17	LT+	External Line Transfer+
5	N/C	No Connection	18	LT-	External Line Transfer-
6	N/C	No Connection	19	CLT-	Camera Line Transfer-
7	CLT+	Camera Line Transfer+	20	LEN+	Line Enable+
8	LEN-	Line Enable-	21	N/C	No Connection
9	N/C	No Connection	22	LR-	Line Reset-
10	LR+	Line Reset+	23	N/C	No Connection
11	N/C	No Connection	24	Video+	Analog Video+
12	Video-	Analog Video-	25	N/C	No Connection
13	Power	Input DC Power			

Table 6. Camera Specifications

Characteristic	Min	Typ	High	Unit
Pixel Spacing	-	14	-	µm
Aperture Width	-	14	-	µm
Spectral Response	350	-	1000	nm
Window	-	Glass	-	-
Anti-Blooming	-	Yes	-	-
Full Scale Output	-	0.75	-	V
Output Impedance	-	100	-	ohm
DC Offset	0	-	45	mV
Exposure Time	-	-	20	mS
Line Period				
LC3011	55.4	-	-	µs
LC3012	106.6	-	-	µs
LC3013	209.0	-	-	µs
LC3021	27.7	-	-	µs
LC3022	53.3	-	-	µs
LC3023	104.5	-	-	µs
Fixed Pattern Noise	-	-	15	mV
Photo Response Non-Uniformity (PRNU)	-	-	±10	%
Random Noise, rms	-	-	1.5	mV
Noise Equivalent Exposure	-	0.06	-	nJ/cm ²
Dynamic Range	-	500:1	-	Range
50% Full Scale Exposure ¹	-	0.015	-	µJ/cm ²
Photo Response	-	25	-	V/µJ/cm ²
Weight	-	15	-	ounces
Dimensions	-	2.5 x 2.5 x 2.72	-	inches
Lens Mount	-	U-Mount	-	-
Random Vibration	-	30	-	g,RMS
Shock (6 axis without lens), Peak	-	300	-	g
Operating Temperature	-20	-	55	°C
Storage Temperature	-40	-	80	°C
Input Voltage	11.5	12	24	VDC
Current @12 VDC ²	-	480	-	mA
Input Power	-	6	-	W

Notes:

1. Measured with 635 nm light source.

2. LC3013PGN-011

Analog Line Scan Camera

Ordering Information

While the information provided in this data sheet is intended to describe the form, fit and function for this product, PerkinElmer reserves the right to make changes without notice.

Table 7. Stock Part Numbers

Camera Model	Resolution	Maximum Data Rate
LC3011PGN-022	512	10MHz
LC3012PGN-022	1024	10MHz
LC3013PGN-022	2048	10MHz
LC3021PGN-022	512	20MHz
LC3022PGN-022	1024	20MHz
LC3023PGN-022	2048	20MHz
LC3011PGC-022 ¹	512	10MHz
LC3012PGC-022 ¹	1024	10MHz
LC3013PGF-022 ²	2048	10MHz
LC3021PGC-022 ¹	512	20MHz
LC3022PGC-022 ¹	1024	20MHz
LC3023PGF-022 ²	2048	20MHz

Notes:

1. Includes C-mount adaptor
2. Includes F-mount adaptor

For more information e-mail us at opto@perkinelmer.com or visit our web site at www.perkinelmer.com/opto. All values are nominal; specifications subject to change without notice.

Table 8. Sales Offices

	North America
United States	PerkinElmer Optoelectronics 2175 Mission College Blvd. Santa Clara, CA 95054 Toll Free: 800-775-OPTO (6786) Phone: +1-408-565-0830 Fax: +1-408-565-0703
Germany	Europe PerkinElmer Optoelectronics GmbH Wenzel-Jaksch-Str. 31 D-65199 Wiesbaden, Germany Phone: +49-611-492-570 Fax: +49-611-492-165
Japan	Asia PerkinElmer Optoelectronics NEopt. 18F, Parale Mitsui Building 8 Higashida-Cho, Kawasaki-Ku Kawasaki-Shi, Kanagawa-Ken 210-0005 Japan Phone: +81-44-200-9170 Fax: +81-44-200-9160 www.neopt.co.jp
Singapore	47 Ayer Rajah Crescent #06-12 Singapore 139947 Phone: +65-770-4925 Fax: +65-777-1008

