

LC66P408

Pin Assignments

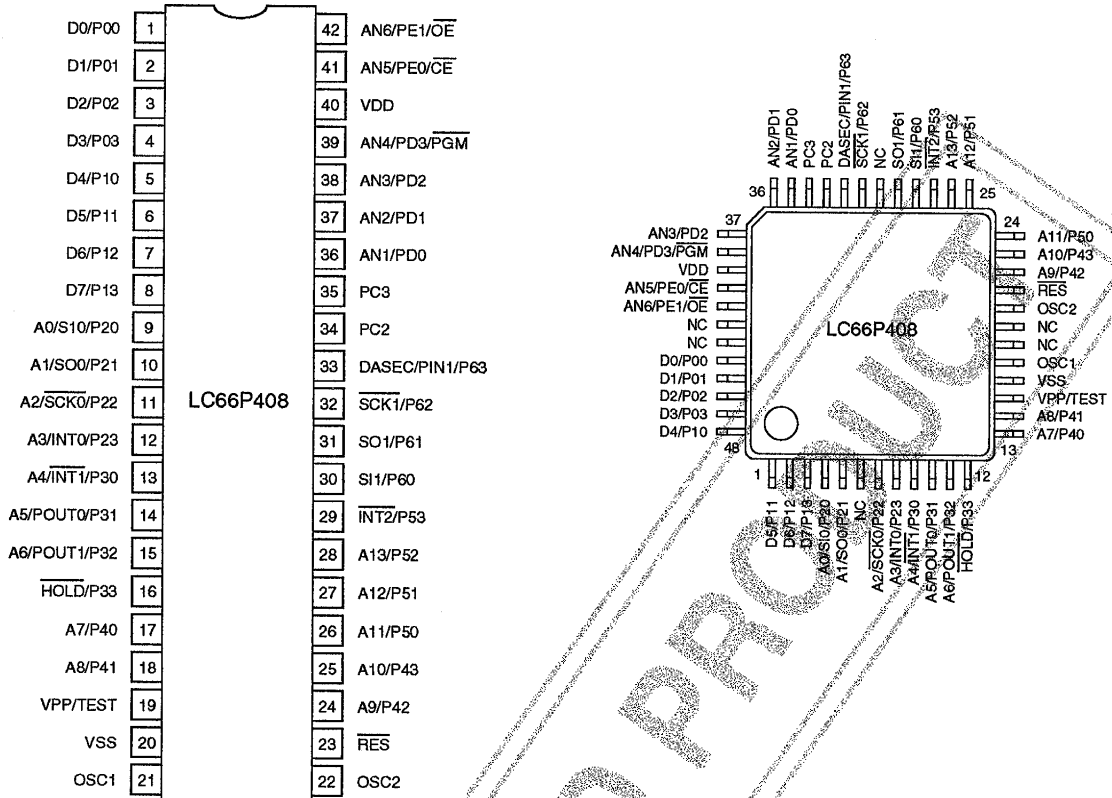

Block Diagram

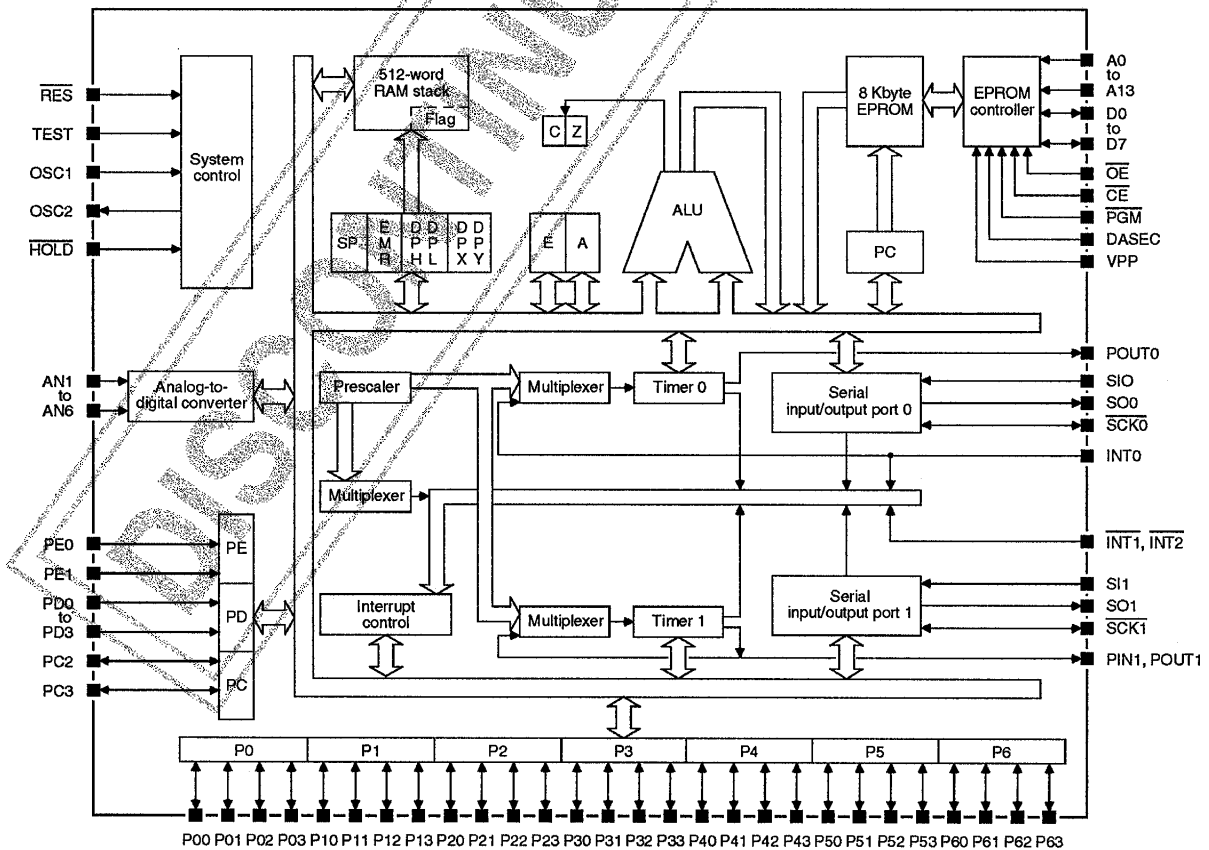

LC66P408

Pin Function

Number		Name	Description
DIP42S	QIP48E		
1	44	D0/P00	Multiplexed 4-bit input/output port P0 (P00 to P03) and PROM data bus lines (D0 to D3)
2	45	D1/P01	
3	46	D2/P02	
4	47	D3/P03	
5	48	D4/P10	Multiplexed 4-bit input/output port P1 (P10 to P13) and PROM data bus lines (D4 to D7)
6	1	D5/P11	
7	2	D6/P12	
8	3	D7/P13	Multiplexed 4-bit input/output port P2 (P20 to P23), serial input 0 (SI0), serial output 0 (SO0), serial clock 0 (SCK0), interrupt request 0 (INT0) and PROM address bus lines (A0 to A3)
9	4	A0/SI0/P20	
10	5	A1/SO0/P21	
11	7	A2/SCK0/P22	
12	8	A3/INT0/P23	Multiplexed 3-bit input/output port P3 (P30 to P32), interrupt request 1 (INT1), timer outputs (POUT0 and POUT1) and PROM address bus lines (A4 to A6)
13	9	A4/INT1/P30	
14	10	A5/POUT0/P31	
15	11	A6/POUT1/P32	Multiplexed single-bit input port (P33) and hold-mode control input (HOLD)
16	12	HOLD/P33	
17	13	A7/P40	Multiplexed 4-bit input/output port P4 (P40 to P43) and PROM address bus lines (A7 to A10)
18	14	A8/P41	
24	22	A9/P42	
25	23	A10/P43	
19	15	VPP/TEST	CPU test input
20	16	V _{SS}	Ground
21	17	OSC1	External oscillator connections
22	20	OSC2	
23	21	RES	Reset input
26	24	A11/P50	Multiplexed 4-bit input/output port P5 (P50 to P53), interrupt request 2 (INT2) and PROM address bus lines (A11 to A13)
27	25	A12/P51	
28	26	A13/P52	
29	27	INT2/P53	Multiplexed 4-bit input/output port P6 (P60 to P63), serial input 1 (SI1), serial output 1 (SO1), serial clock 1 (SCK1), event counter input (PIN1) and PROM data security control input (DASEC)
30	28	SI1/P60	
31	29	SO1/P61	
32	31	SCK1/P62	
33	32	DASEC/PIN1/P63	2-bit input/output port PC
34	33	PC2	
35	34	PC3	
36	35	AN1/PD0	Multiplexed 4-bit input port PD (PD0 to PD3), PROM program control input (PGM) and analog-to-digital converter inputs (AN1 to AN4)
37	36	AN2/PD1	
38	37	AN3/PD2	
39	38	AN4/PD3/PGM	
40	39	V _{DD}	5 V supply
41	40	AN5/PE0/CE	Multiplexed 2-bit input port PE (PE0 to PE1), PROM chip enable (CE) and output enable (OE), and analog-to-digital converter inputs (AN5 and AN6)
42	41	AN6/PE1/OE	
	6, 18, 19, 30, 42, 43	NC	No connection

LC66P408

Specifications

Absolute Maximum Ratings

Parameter	Symbol	Conditions	Ratings	Unit
Supply voltage	V_{DD}		-0.3 to +7.0	V
Ports P2 to P6 (excluding P33) input voltage	V_{I1}	See note 1	-0.3 to +15.0	V
Input voltage range for all inputs	V_{I2}	See note 2	-0.3 to $V_{DD} + 0.3$	V
Ports P2 to P6 (excluding P33) output voltage	V_{O1}	See note 1	-0.3 to +15.0	V
Output voltage range for all outputs	V_{O2}	See note 2	-0.3 to $V_{DD} + 0.3$	V
Ports P0, P1, P4, and P5 output source current	$-I_{OP1}$		2	mA
Ports P2, P3 (excluding P33), P6 and PC output source current	$-I_{OP2}$		4	mA
Ports P0 to P6 (excluding P33) and PC output sink current	I_{ON}		20	mA
Ports P0 to P3 (excluding P33), P40 and P41 total sink current	I_{ON1}		75	mA
Ports P42, P43, P5, P6 and PC total sink current	I_{ON2}		75	mA
Ports P0 to P3 (excluding P33), P40 and P41 total source current	$-I_{OP1}$		25	mA
Ports P42, P43, P5, P6 and PC total source current	$-I_{OP2}$		25	mA
Allowable power dissipation	P_{D1}	DIP42S	600	mW
Allowable power dissipation	P_{D2}	QIP48E, See note 3	430	mW
Operating temperature	T_{op}		-30 to +70	°C
Storage temperature	T_{stg}		-55 to +125	°C

Notes

1. Open-drain output configuration option
2. All output configuration options
3. Heat-soak the QIP package before mounting. Do not immerse the package in the solder dip tank when mounting the QIP on the substrate, and avoid prolonged contact with the solder.

Recommended Operating Conditions at $T_a = 25^\circ\text{C}$, $V_{SS} = 0\text{V}$

Parameter	Symbol	Conditions	Ratings	Unit
Supply voltage	V_{DD}		5	V
Supply voltage range	V_{DD}		4.5 to 5.5	V
Hold-mode supply voltage range for data retention	V_{DD}		1.8 to 5.5	V

Electrical Characteristics at $T_a = -30$ to $+70^\circ\text{C}$, $V_{DD} = 4.5$ to 5.5V , $V_{SS} = 0\text{V}$ unless otherwise noted

Parameter	Symbol	Conditions	Ratings			Unit
			min	typ	max	
Reset-mode supply current	I_{DD}	4 MHz ceramic resonator		4.5	8.0	mA
		4 MHz external clock		6.5	11.0	mA
		RC oscillator		4	8	mA
Halt-mode supply current	I_{DDHT}	4 MHz ceramic resonator		3.0	5.5	mA
		4 MHz external clock		3.5	6.0	mA
		RC oscillator		3.0	5.5	mA
Hold-mode supply current	I_{DDHD}	$V_{DD} = 1.8$ to 5.5V		0.01	10.0	μA
Ports P2, P3 (excluding P33), P5 and P6, RES and OSC1 input low-level voltage	V_{IL1}	Output n-channel transistor OFF. See note 1.	V_{SS}		$0.25V_{DD}$	V
HOLD/P33 input low-level voltage	V_{IL2}	$V_{DD} = 1.8$ to 5.5V	V_{SS}		$0.25V_{DD}$	V
Ports P0, P1, P4, PC, PD and PE and TEST input low-level voltage	V_{IL3}	Output n-channel transistor OFF. See note 1.	V_{SS}		$0.3V_{DD}$	V
Ports P2 to P6 (excluding P33) input high-level voltage	V_{IH1}	Output n-channel transistor OFF. See note 2.	$0.75V_{DD}$		13.5	V
HOLD/P33, RES and OSC1 input high-level voltage	V_{IH2}	Output n-channel transistor OFF	$0.75V_{DD}$		V_{DD}	V
Ports P0, P1, PC, PD and PE input high-level voltage	V_{IH3}	Output n-channel transistor OFF. See note 1.	$0.7V_{DD}$		V_{DD}	V
Ports P0 to P6 (excluding P33) and PC output low-level voltage	V_{OL}	$I_{OL} = 1.6\text{ mA}$			0.4	V
		$I_{OL} = 1.6\text{ mA}$			1.5	V
Ports P2, P3 (excluding P33), P6 and PC output high-level voltage	V_{OH1}	$I_{OH} = -1\text{ mA}$. See note 3.	$V_{DD} - 1.0$			V
		$I_{OH} = -0.1\text{ mA}$. See note 3.	$V_{DD} - 0.5$			V
Ports P0, P1, P4 and P5 output high-level voltage	V_{OH2}	$V_{DD} = 4.5\text{ V}$, $I_{OH} = -0.2\text{ mA}$. See note 4.	2.4			V
		$I_{OH} = -0.13\text{ mA}$. See note 4.	$V_{DD} - 1.35$			V

Continued on next page.

LC66P408

Continued from preceding page.

Parameter	Symbol	Conditions	Ratings			Unit
			min	typ	max	
Ports P2, P3, P5 and P6, and RES and OSC1 Schmitt-trigger low-level threshold voltage	V_{TL}		0.25 V_{DD}		0.5 V_{DD}	V
Ports P2, P3, P5, and P6, and RES and OSC1 Schmitt-trigger high-level threshold voltage	V_{TH}		0.5 V_{DD}		0.75 V_{DD}	V
Ports P2, P3, P5 and P6, RES and OSC1 Schmitt-trigger hysteresis voltage	V_{HYS}			0.1 V_{DD}		V
Input low-level current for all inputs	I_{IL}	$V_I = V_{SS}$, output n-channel transistor OFF. See note 2.	-1			μ A
Ports P2 to P6 (excluding P33) input high-level current	I_{IH1}	$V_I = 13.5$ V, output n-channel transistor OFF. See note 2.			5	μ A
Ports P0, P1 and P33, and RES and OSC1 input high-level current	I_{IH2}	$V_I = V_{DD}$, output n-channel transistor OFF. See note 1.			1	μ A
Ports PC2, PC3, PD and PE input high-level current	I_{IH3}	$V_I = V_{DD}$, output n-channel transistor OFF. See note 1.			1	μ A
Ports P2 to P6 output leakage current	I_{OFF1}	$V_I = 13.5$ V. See note 2.			5	μ A
Ports P0, P1 and PC output leakage current	I_{OFF2}	$V_I = V_{DD}$. See note 2.			1	μ A
Ports P0, P1, P4 and P5 output current with pull-up option	I_{PO}	$V_I = V_{SS}$, $V_{DD} = 5.5$ V. See note 4.	-1.6			mA
Ceramic resonator input frequency	f_{CF}			4		MHz
Ceramic resonator input stabilization time	t_{CFS}				10	ms
RC oscillator input frequency	f_{RC}	$R = 2.2$ k $\Omega \pm 1\%$, $C = 100$ pF $\pm 1\%$	2	3	4	MHz
External RC oscillator capacitance	C_{ext}			100		pF
External RC oscillator resistance	R_{ext}			2.2		k Ω

Notes

1. Ports with CMOS output configuration option cannot be used as input ports.
2. Open-drain output configuration option
3. CMOS output configuration option
4. Pull-up output configuration option

A/D converter characteristics at $T_a = -30$ to $+70$ °C, $V_{DD} = 4.5$ to 5.5 V, $V_{SS} = 0$ V

Parameter	Symbol	Conditions	Ratings			Unit
			min	typ	max	
Resolution	R_{res}			6		bit
Absolute accuracy	A_{ABS}			± 1	± 1.5	lsb
Linearity error	L_{in}			± 0.5	± 1	lsb
AN1 to AN6 analog input voltage	V_{INAD}		V_{SS}		V_{DD}	V
Low-speed conversion time	t_{CADL}			128 t_{CYC}	256 t_{CYC}	μ s
High-speed conversion time	t_{CADH}			64 t_{CYC}	128 t_{CYC}	μ s

Comparator characteristics at $T_a = -30$ to $+70$ °C, $V_{DD} = 4.5$ to 5.5 V, $V_{SS} = 0$ V

Parameter	Symbol	Conditions	Ratings			Unit
			min	typ	max	
AN1 to AN6 comparator accuracy	A_{CECM}			± 1	± 1.5	lsb
AN1 to AN6 threshold voltage	V_{THCM}			± 0.5	± 1	lsb
AN1 to AN6 analog input voltage	V_{INAD}		V_{SS}		V_{DD}	V
AN1 to AN6 input voltage	V_{INCM}		V_{SS}		V_{DD}	V
Conversion time	t_{CCM}				30	μ s

LC66P408

Timing Characteristics Serial input/output timing

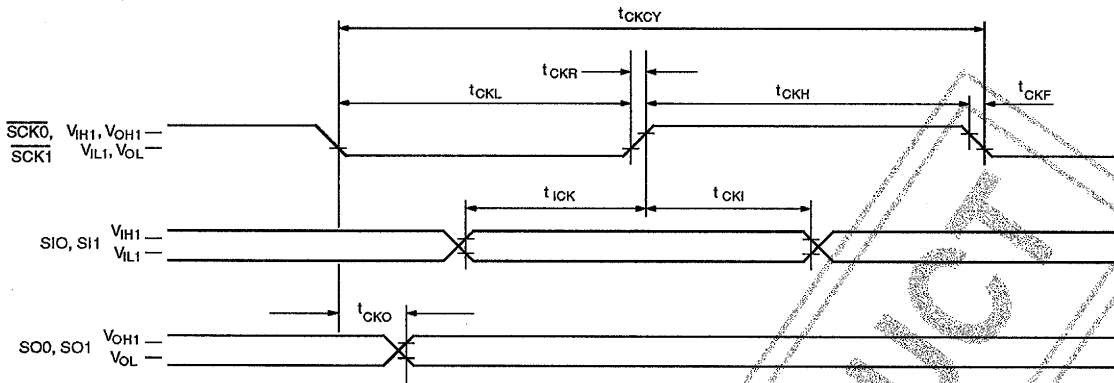

$T_a = -30$ to $+70$ °C, $V_{DD} = 4.5$ to 5.5 V, $V_{SS} = 0$ V

Parameter	Symbol	Conditions	Ratings			Unit
			min	typ	max	
Instruction cycle time	t_{CYC}		0.92		10	μ s
SCK0 and SCK1 serial clock input cycle time	t_{CKCY}		0.9			μ s
SCK0 and SCK1 serial clock output cycle time	t_{OCY}		$2t_{CYC}$			μ s
SCK0 and SCK1 serial clock input pulsewidth	t_{CKL}		0.4			μ s
SCK0 and SCK1 serial clock output pulsewidth	t_{CKH}		t_{CYC}			μ s
SCK0 and SCK1 serial clock output rise time	t_{CKR}				0.1	μ s
SCK0 and SCK1 serial clock output fall time	t_{CKF}				0.1	μ s
SIO and SI1 serial data setup time	t_{ICK}		0.3			μ s
SIO and SI1 serial data hold time	t_{CKI}		0.3			μ s
SO0 and SO1 serial data output delay	t_{CKO}				0.3	μ s

Note

Each test input and output has an RC load as shown in the following figure.

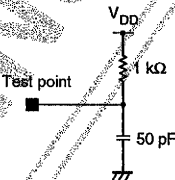

External clock timing

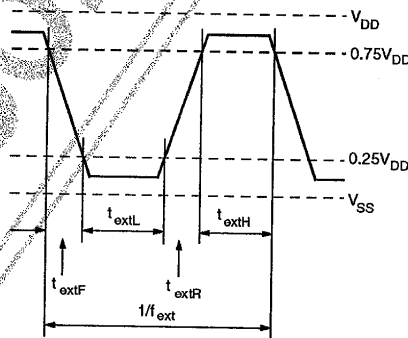

$T_a = -30$ to $+70$ °C, $V_{DD} = 4.5$ to 5.5 V, $V_{SS} = 0$ V

Parameter	Symbol	Conditions	Ratings			Unit
			min	typ	max	
OSC1 external clock input frequency	f_{ext}		0.4		4.35	MHz
OSC1 external clock input low-level pulsewidth	t_{extL}		70			ns
OSC1 external clock input high-level pulsewidth	t_{extH}		70			ns
OSC1 external clock input rise time	t_{extR}				30	ns
OSC1 external clock input fall time	t_{extF}				30	ns

LC66P408

Interrupt and reset timing

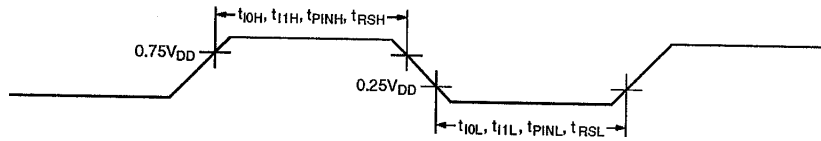

Ta = -30 to +70 °C, V_{DD} = 4.5 to 5.5 V, V_{SS} = 0 V

Parameter	Symbol	Conditions	Ratings			Unit
			min	typ	max	
INT0 low-level pulsewidth	t _{IOL}		2t _{CYC}			μs
INT0 high-level pulsewidth	t _{IOH}		2t _{CYC}			μs
INT1 and INT2 low-level pulsewidth	t _{I1L}		2t _{CYC}			μs
INT1 and INT2 high-level pulsewidth	t _{I1H}		2t _{CYC}			μs
PIN1 input low-level pulsewidth	t _{PINL}		2t _{CYC}			μs
PIN1 input high-level pulsewidth	t _{PINH}		2t _{CYC}			μs
RES input low-level pulsewidth	t _{RSL}		3t _{CYC}			μs
RES input high-level pulsewidth	t _{RSH}		3t _{CYC}			μs

Input and Output Functions

The LC66P408 has many multiplexed pins whose function is controlled by software. The function of each of these pins is shown in the following table.

Name	Function
D0/P00	Ports P00 to P03 can be addressed as either a 4-bit port or four single-bit ports. They function as data bus lines when memory is addressed. They also have halt-mode control functions.
D1/P01	
D2/P02	
D3/P03	
D4/P10	Ports P10 to P13 can be addressed as either a 4-bit port or four, single-bit ports. They function as data bus lines when memory is addressed.
D5/P11	
D6/P12	
D7/P13	
A0/SIO/P20	Ports P20 to P23 can be addressed as either a 4-bit port or four single-bit ports. They function as address bus inputs when memory is addressed. Port P20 also functions as a serial data input, P21 as a serial data output, P22 as a serial data clock and P23 as an interrupt request, pulsewidth measurement and event counter input using timer 0.
A1/SO0/P21	
A2/SCK0/P22	
A3/INT0/P23	
A4/INT1/P30	Ports P30 to P32 can be addressed as either a 3-bit port, a 4-bit port with P33 or three, single-bit ports. They function as address bus inputs when memory is addressed. Port P30 also functions as an interrupt request input, P31 as a square-wave output from timer 0 and P32 as a square-wave output from timer 1 and a PWM output.
A5/POUT0/P31	
A6/POUT1/P32	
HOLD/P33	
A7/P40	Ports P40 to P43 can be addressed as either a 4-bit port, four single-bit ports or an 8-bit port with P50 to P53. They function as address bus inputs when memory is addressed.
A8/P41	
A9/P42	
A10/P43	
A11/P50	Ports P50 to P53 can be addressed as either a 4-bit port, four single-bit ports or an 8-bit port with P40 to P43. Ports P50 to P52 function as address bus inputs when memory is addressed. Port P53 also function as an interrupt request input.
A12/P51	
A13/P52	
INT2/P53	Ports P60 to P63 can be addressed as either a 4-bit port or four single-bit ports. Port P60 also function as a serial data input, P61 as a serial data output, P62 as a serial data clock and P63 as a data security control input and timer 1 event counter input.
SI1/P60	
SO1/P61	
SCK1/P62	
DASEC/PIN1/P63	Ports PC2 and PC3 can be addressed as either a 2-bit port or two, single-bit ports.
PC2	
PC3	
AN1/PD0	Ports PD0 to PD3 can be addressed as either a 4-bit port or four single-bit ports. They also function as analog-to-digital converter inputs. In addition, port PD3 also functions as the memory program control input.
AN2/PD1	
AN3/PD2	
AN4/PD3/PGM	

Continued on next page.

Continued from preceding page.

Name	Function
AN5/PE0/CE	Ports PE0 to PE1 can be addressed as either a 2-bit port or two single-bit ports. They function as chip enable and write enable, respectively, when memory is addressed. They also function as analog-to-digital converter inputs.
AN6/PE1/OE	
OSC1	OSC1 and OSC2 function as the external ceramic resonator or RC oscillator connections. When an external clock is used, OSC2 is left open.
OSC2	
RES	When RES goes LOW while HOLD/P33 is HIGH, the CPU is reset.
VPP/TEST	CPU test input. Normally connected to ground

User Options

Oscillator Options

There are three user options for the oscillator : an external clock, an RC oscillator and a ceramic resonator. The internal circuits of OSC1 and OSC2 for the external clock, RC oscillator and ceramic resonator options are shown in figures 1, 2 and 3, respectively. Note the Schmitt-trigger inputs for both the external clock and RC oscillator options.

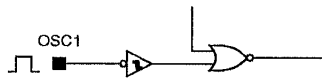

Figure 1. External clock option

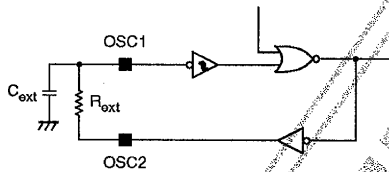

Figure 2. RC oscillator option

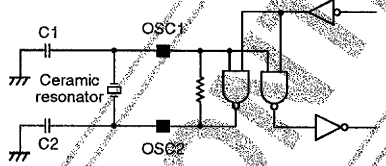

Figure 3. Ceramic resonator option

Output Options

There are two user options for the output configuration of each port—n-channel open drain and p-channel, active pull-up, shown in figures 4 and 5, respectively. Ports P2, P3, P5 and P6 have Schmitt-trigger inputs in both output configurations.

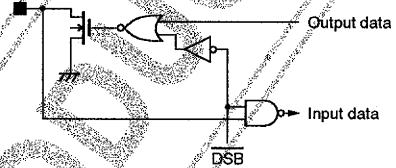

Figure 4. N-channel open-drain option

The p-channel pull-up option for ports P0, P1, P4 and P5 results in an n-channel sink transistor with a p-channel, active pull-up transistor configuration, and for ports P2, P3, P6 and PC, a CMOS configuration.

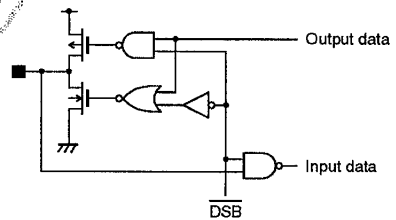

Figure 5. P-channel pull-up option

The n-channel open-drain outputs for ports P2 to P6 have a withstand voltage greater than 15 V.

Output Level After Reset Option

The output level of ports P0 and P1 after a CPU reset is user selectable.

Watchdog Timer Option

A watchdog timer is available to prevent program run-away.

LC66P408

PROM Specification Specifying Programs and Options

The user-addressable memory is 0000H to 2007H. Addresses 0000H to 1FFFH are for user programs, and addresses 2000H to 2007H, for option specification. The

option specification is coded using the information shown in the following table.

Address	Data bit	Parameter	Option	
			0	1
2000H	D0	Watchdog timer function	No	Yes
	D1	Port P0 level after reset	LOW	HIGH
	D2	Port P1 level after reset	LOW	HIGH
	D3	No function	Set to 0	
	D4	Oscillator	RC oscillator or external clock	Ceramic resonator
	D5 to D7	No function	Set to 0	
2001H	D0	Port P00 output configuration	Open-drain	Pull-up
	D1	Port P01 output configuration		
	D2	Port P02 output configuration		
	D3	Port P03 output configuration		
	D4	Port P10 output configuration	Open-drain	Pull-up
	D5	Port P11 output configuration		
	D6	Port P12 output configuration		
2002H	D0	Port P20 output configuration	Open-drain	Pull-up
	D1	Port P21 output configuration		
	D2	Port P22 output configuration		
	D3	Port P23 output configuration		
	D4	Port P30 output configuration	Open-drain	Pull-up
	D5	Port P31 output configuration		
	D6	Port P32 output configuration		
D7	No function	Set to 0		
2003H	D0	Port P40 output configuration	Open-drain	Pull-up
	D1	Port P41 output configuration		
	D2	Port P42 output configuration		
	D3	Port P43 output configuration		
	D4	Port P50 output configuration	Open-drain	Pull-up
	D5	Port P51 output configuration		
	D6	Port P52 output configuration		
2004H	D0	Port P60 output configuration	Open-drain	Pull-up
	D1	Port P61 output configuration		
	D2	Port P62 output configuration		
	D3	Port P63 output configuration		
	D4 to D7	No function	Set to 0	
2005H	D0 to D7	No function	Set to 0	
2006H	D0 to D7	No function	Set to 0	
2007H	D0, D1	No function	Set to 0	
	D2	Port PC2 output configuration	Open-drain	Pull-up
	D3	Port PC3 output configuration		
	D4 to D7	No function	Set to 0	

Note

Ports with CMOS output configuration cannot be used as input ports.

The assembler execute command when specifying programs and options using a SANYO cross assembler is LC66S.EXE.

LC66P408

PROM Programming

The PROM can be programmed using a special adapter board, W66EP308D/408D for the 42-pin DIP and

W66EP308Q/408Q for the 48-pin QIP as shown in the following figure, and a universal EPROM programmer.

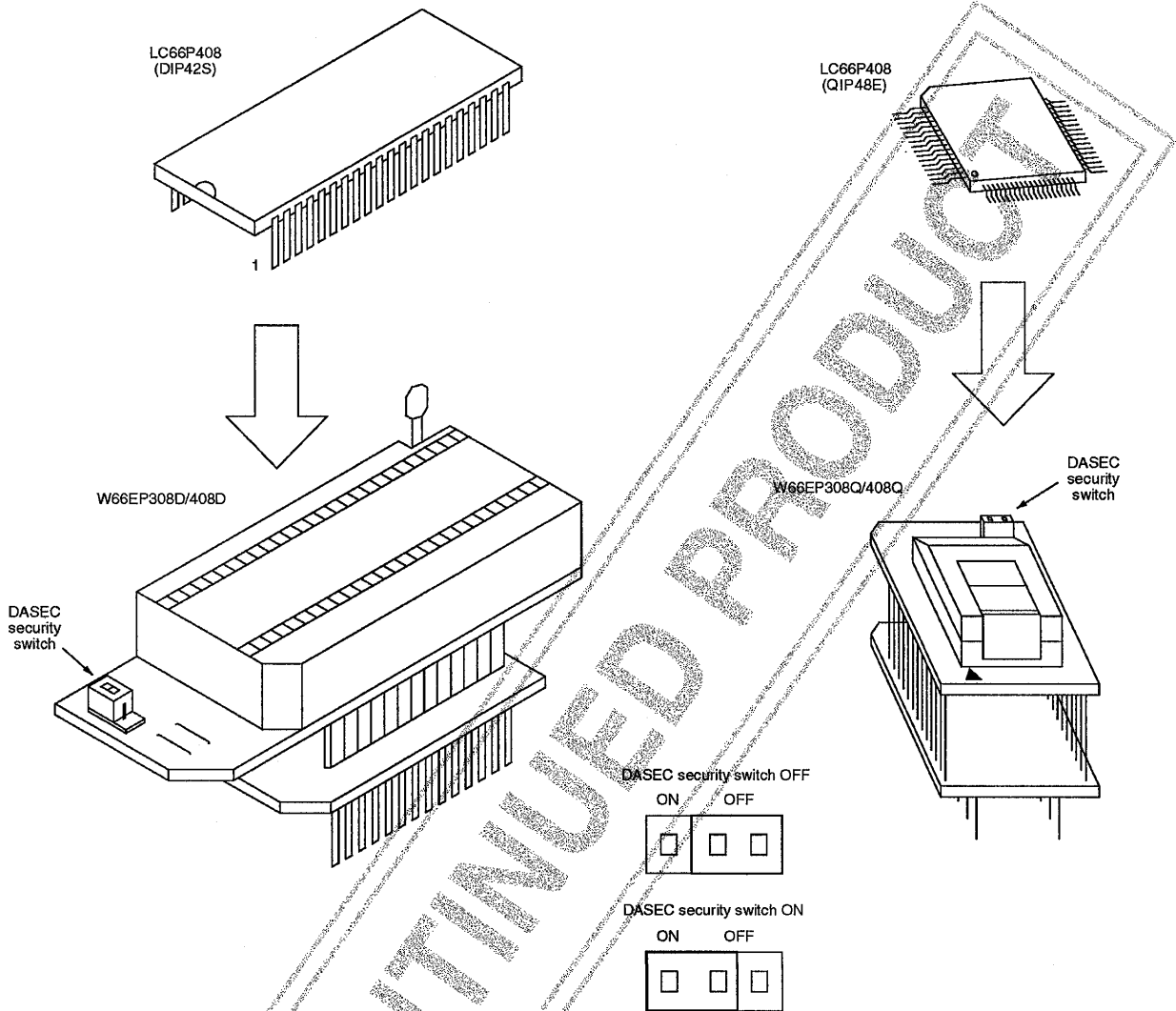

The PROM address range is 0000H to 2007H. Addresses 2008H and above cannot be either programmed or read. The EPROM programmer should be Intel 27128 compatible with $V_{PP} = 21\text{ V}$. The recommended programmers are shown in the following table. Please contact your nearest SANYO representative if you intend to use an alternative EPROM programmer.

Manufacturer	Model
ADVANTEST	TR4943, R4944A, R4945 or equivalent
SANYO	EVA850 or EVA800 special-purpose programmers

Note

Intel is a registered trademark of Intel Corporation.
 ADVANTEST is a registered trademark of ADVANTEST Corporation.

The EPROM programmer adapter incorporates a data security switch. When this switch is ON, data is secure, and when OFF, the data lines are floating and the PROM can be programmed. Note that when the data lines are floating, the EPROM programmer will return an error. This error can be ignored.

APPLICATION NOTES

Reset Timing

The reset signal on $\overline{\text{RES}}$ should be held LOW for a minimum of three instruction cycles after the oscillator has

stabilized to ensure correct operation, as shown in the following figure.

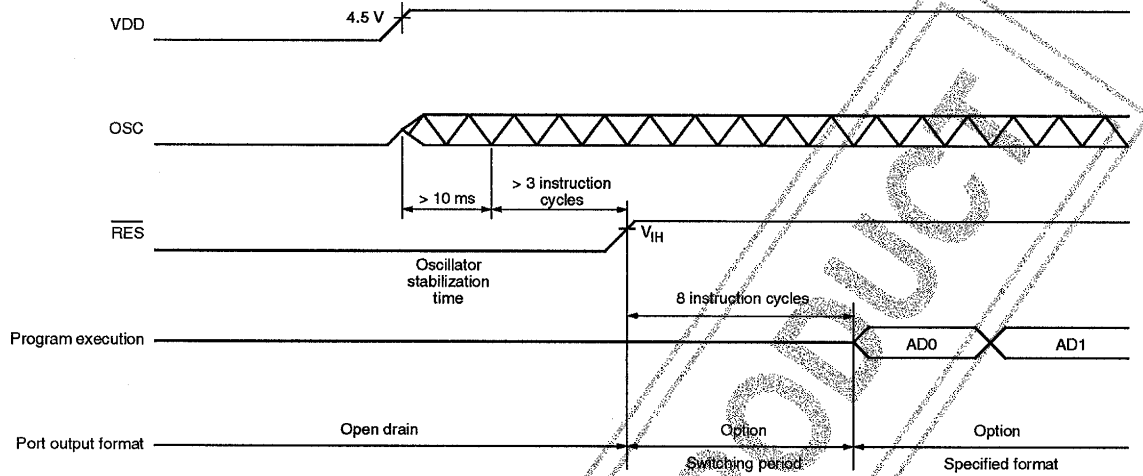

After a reset occurs, all I/O ports are reset to open-drain output configuration with floating outputs, except for ports P0 and P1 which both have an output level after reset option. The output configuration of each port is then set using the specified options during the eight instruction cycles after $\overline{\text{RES}}$ goes HIGH. Program execution then begins from address 0000H.

The LC66E408/P408 can also be reset while in hold mode ($\overline{\text{HOLD/P33}}$ is LOW) as long as hold mode is exited before $\overline{\text{RES}}$ goes HIGH again.

Reference Clock

The external circuit for a ceramic resonator is shown in figure 6, and the recommended resonator and component values, in the following table. The oscillator stabilization characteristics are shown in figure 7.

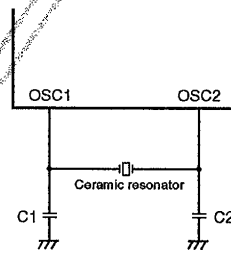
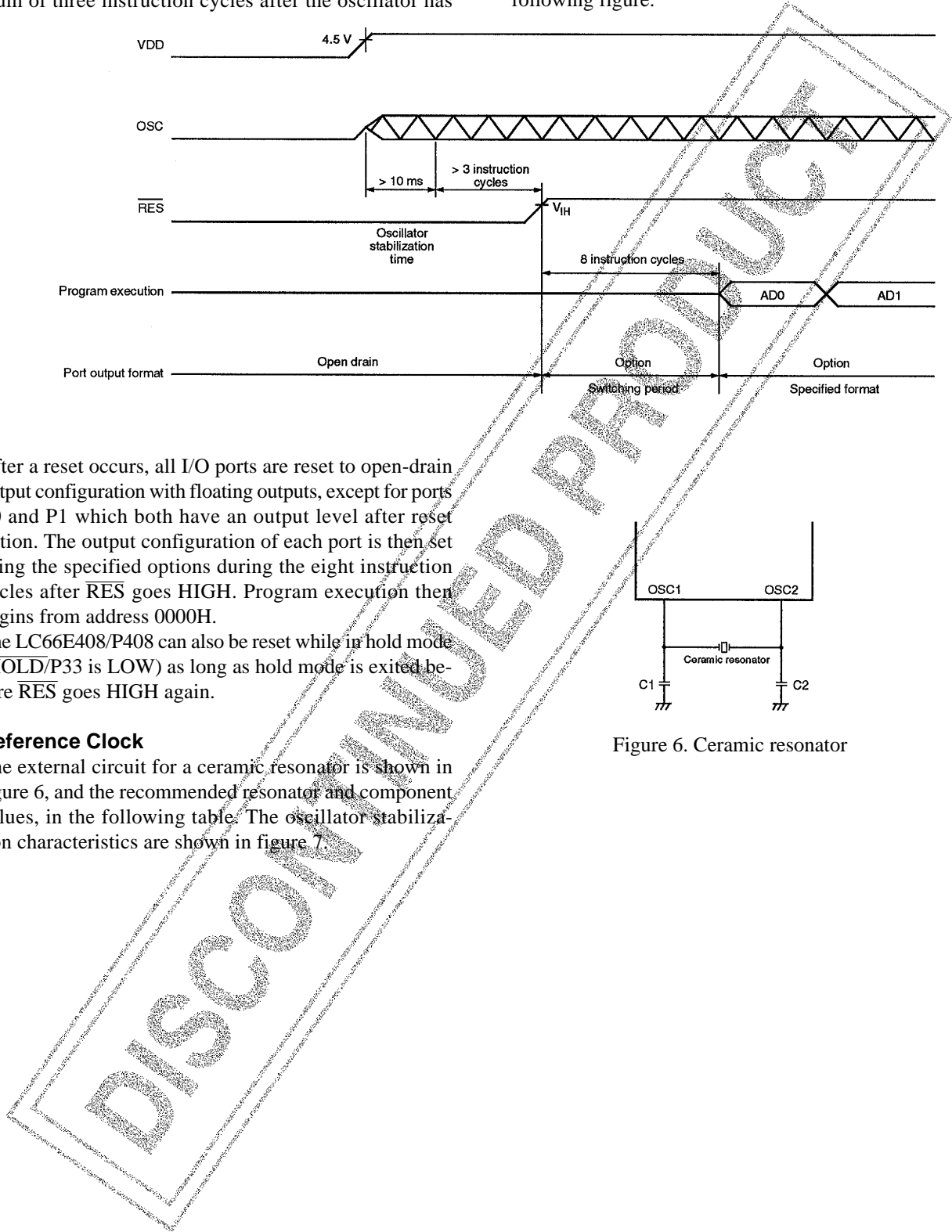

Figure 6. Ceramic resonator



LC66P408

Ceramic resonator	Capacitance	
	C1	C2
4 MHz Murata CSA -4.00MG	33 pF ±10%	33 pF ±10%
4 MHz Kyocera KBR -4.0MS	33 pF ±10%	33 pF ±10%
4 MHz Murata CST -4.00MG with internal capacitor	N/A	N/A
4 MHz Kyocera KBR -4.0MES with internal capacitor	N/A	N/A

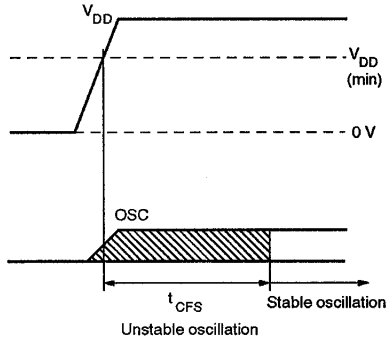
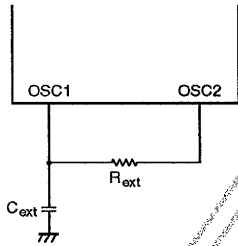
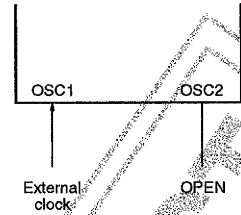

Figure 7. Ceramic resonator stabilization time

The external circuit for an RC oscillator is shown in the following figure.



The external clock input connection is OSC1. The remaining oscillator connection, OSC2, should be left open as shown in the following figure.



The RC oscillator frequency is determined by the external resistor and capacitor and has only been specified for $R_{ext} = 2.2 \text{ k}\Omega$ and $C_{ext} = 100 \text{ pF}$. The frequency for other values of R_{ext} and C_{ext} can be determined from the graph in the following figure.

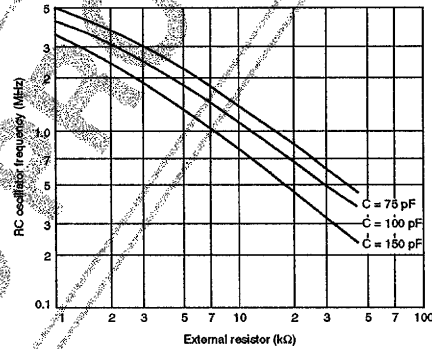

Preparation Procedure

The preparation procedures shown in the following figure for DIP and QFP packages should always be followed prior to mounting the packages on the substrate.

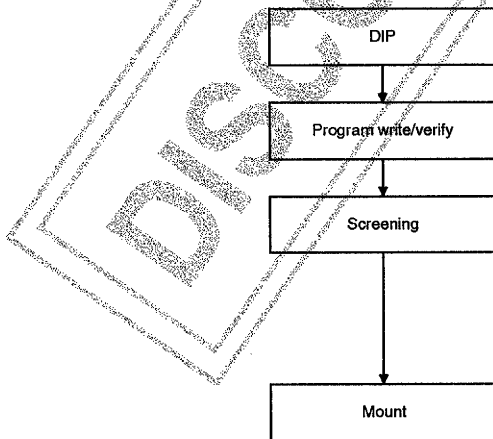

Note that the QIP package should be heat-soaked for 24 hours at 125 °C immediately prior to mounting.

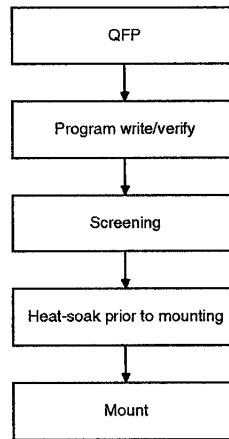

LC66P408

Screening procedure

The construction of the microcontroller with a blank built-in PROM makes it impossible for SANYO to completely factory-test it before shipping. To prove reliability of the programmed devices, the screening procedure shown in the following figure should always be followed.

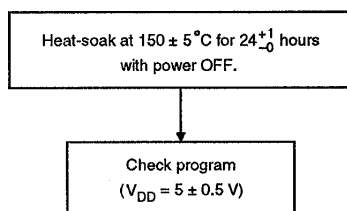

Note that it is not possible to perform a write test on the blank PROM. 100% yield, therefore, cannot be guaranteed.

Ordering Information

When ordering identical mask ROM and PROM devices simultaneously, provide an EPROM containing the target memory contents together with separate order forms for each of the mask ROM and PROM versions.

When ordering a PROM device, provide an EPROM containing the target memory contents together with an order form.

When ordering either an LC66404A 4 Kbyte or LC66406A 6 Kbyte mask ROM device, insert a jump command, or

any similar command, to avoid executing an address beyond the range of the target device. In addition, write a 0 into all locations above 2007H.

A comparison of the LC66P408 characteristics with those of the LC6640X mask ROM devices is shown in the following table.

Parameter	Symbol	Condition	LC66P408	LC6640X series	Unit
Recommended supply voltage range	V _{DD}		4.5 to 5.5	4.0 to 6.0	V
Maximum halt-mode supply current	I _{DDHT}	4-MHz ceramic resonator	5.5	3.0	mA
		4 MHz external clock	6.0	3.5	
		RC oscillator	5.5	5.5	
External RC oscillator capacitance	C _{ext}		100	100	pF
External RC oscillator resistance	R _{ext}		2.2	2.7	kΩ
Port output configuration after reset			Open-drain (P0 and P1 also have pull-up)	Specified by user option	

A breakdown of the LC66 series devices, which includes the LC66408 and LC6640X devices, is shown in the following table.

Device	Pin	ROM capacity	RAM capacity	Package type
LC66304A/306A/308A	42	4/6/8 Kbyte ROM	512 bytes	DIP42S or QIP48E
LC66E308	42	8 Kbyte EPROM		DIC42S or QFC48
LC66P308	42	8 Kbyte PROM		DIP42S or QIP48E
LC66404A/406A/408	42	4/6/8 Kbyte ROM		DIP42S or QIP48E
LC66E408	42	8 Kbyte EPROM		DIC42S or QFC48
LC66P408	42	8 Kbyte PROM		DIP42S or QIP48E
LC66506B/508B/512B/516B	64	6/8/12/16 Kbyte ROM		DIP64S or QIP64A
LC66E516	64	16 Kbyte EPROM		DIC64S or QFC64
LC66P516	64	16 Kbyte PROM		DIP64S or QIP64E

SANYO ROM Services

SANYO offers various services at nominal charges. These include ROM writing, ROM reading, and package stamping and screening. Contact your local SANYO representative for further information.

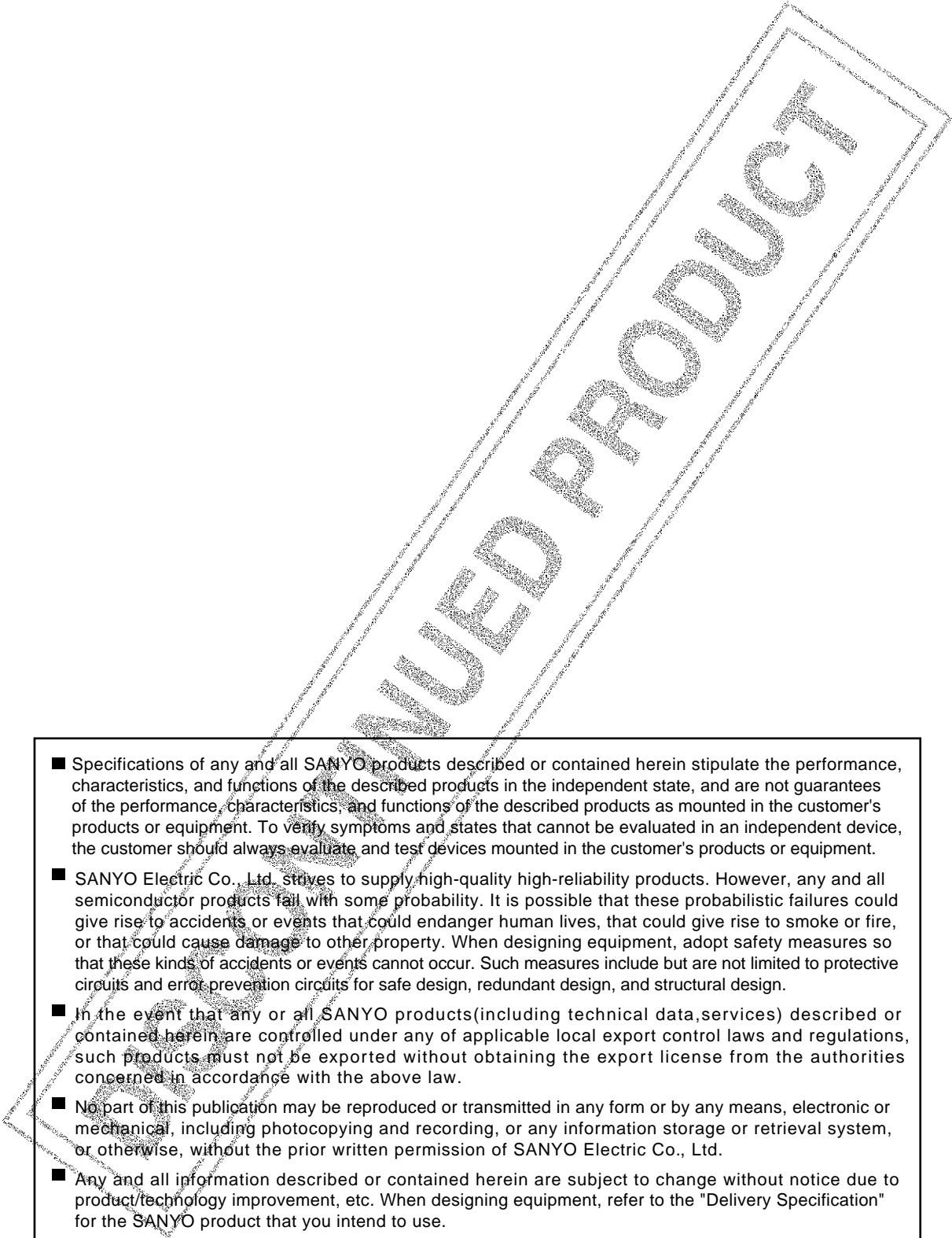
- 
- Specifications of any and all SANYO products described or contained herein stipulate the performance, characteristics, and functions of the described products in the independent state, and are not guarantees of the performance, characteristics, and functions of the described products as mounted in the customer's products or equipment. To verify symptoms and states that cannot be evaluated in an independent device, the customer should always evaluate and test devices mounted in the customer's products or equipment.
 - SANYO Electric Co., Ltd. strives to supply high-quality high-reliability products. However, any and all semiconductor products fail with some probability. It is possible that these probabilistic failures could give rise to accidents or events that could endanger human lives, that could give rise to smoke or fire, or that could cause damage to other property. When designing equipment, adopt safety measures so that these kinds of accidents or events cannot occur. Such measures include but are not limited to protective circuits and error prevention circuits for safe design, redundant design, and structural design.
 - In the event that any or all SANYO products (including technical data, services) described or contained herein are controlled under any of applicable local export control laws and regulations, such products must not be exported without obtaining the export license from the authorities concerned in accordance with the above law.
 - No part of this publication may be reproduced or transmitted in any form or by any means, electronic or mechanical, including photocopying and recording, or any information storage or retrieval system, or otherwise, without the prior written permission of SANYO Electric Co., Ltd.
 - Any and all information described or contained herein are subject to change without notice due to product/technology improvement, etc. When designing equipment, refer to the "Delivery Specification" for the SANYO product that you intend to use.
 - Information (including circuit diagrams and circuit parameters) herein is for example only ; it is not guaranteed for volume production. SANYO believes information herein is accurate and reliable, but no guarantees are made or implied regarding its use or any infringements of intellectual property rights or other rights of third parties.

This catalog provides information as of October, 2001. Specifications and information herein are subject to change without notice.