



# LC7367J, 7367JM

## DTMF/PULSE Switchable Dialer

### Overview

The LC7367J, 7367JM are DTMF/OUTPUT-PULSE dialer CMOS ICs with redial function for use in pushbutton telephones.

### Features

- Low voltage CMOS process for direct operation from telephone line.
- Possible to use single contact or standard 2-of-7, 2-of-8 key pad.
- Possible to use color-burst crystal resonator for on-chip oscillator ( $f_{OSC}=3.58\text{MHz}$ ).
- Possible to use either mode select pin (P/T) or function key (4x4 matrix key) to select DTMF mode/OUTPUT-PULSE mode.
- Mode change with MC key is made in one direction only from pulse mode to tone mode.
- Delivers 12 DTMF signals when in DTMF mode.
- On-chip 31-digit redial memory.
- Possible to provide mix redial (31 digits-PAUSE-MC) of DTMF/OUTPUT-PULSE mode.
- Either auto pause select (4s.xn) or manual release available for mode select standby time during redial operation.
- Output pulse make rate of OUTPUT-PULSE mode : Pin-selectable (33.2% or 40%).
- Output pulse rate of OUTPUT-PULSE mode : Pin-selectable (10pps or 20pps).
- On-chip circuit to prevent malfunction due to noise pulse caused by key entry.
- Key touch tone (pacifier tone) output capability.  
OUTPUT-PULSE mode : 1243Hz/50ms
- Supply voltage / operating temperature  
DTMF mode :  
 $V_{DD}=2.0$  to  $6.0\text{V}$  /  $T_a=-30$  to  $+70^\circ\text{C}$   
OUTPUT-PULSE mode :  
 $V_{DD}=1.5$  to  $6.0\text{V}$  /  $T_a=-30$  to  $+70^\circ\text{C}$

### • Operating current

DTMF mode :

$$I_{DD}=1.0\text{mA max} / V_{DD}=3.5\text{V}$$

OUTPUT-PULSE mode :

$$I_{DD}=500\mu\text{A max} / V_{DD}=3.5\text{V}$$

Continued on next page.

### Package Dimensions

unit:mm

#### 3059-DIP22S

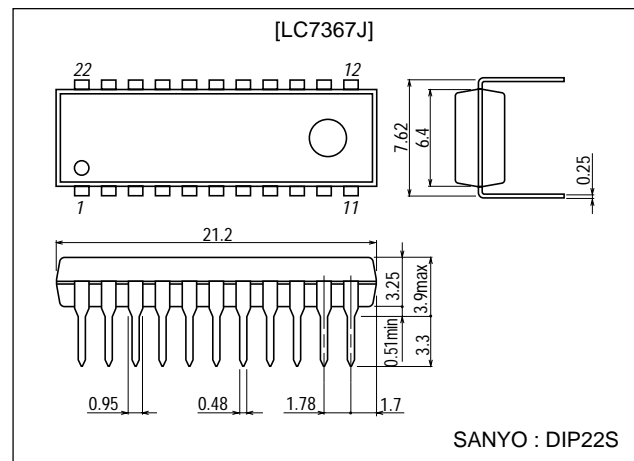

unit:mm

#### 3073A-MFP30

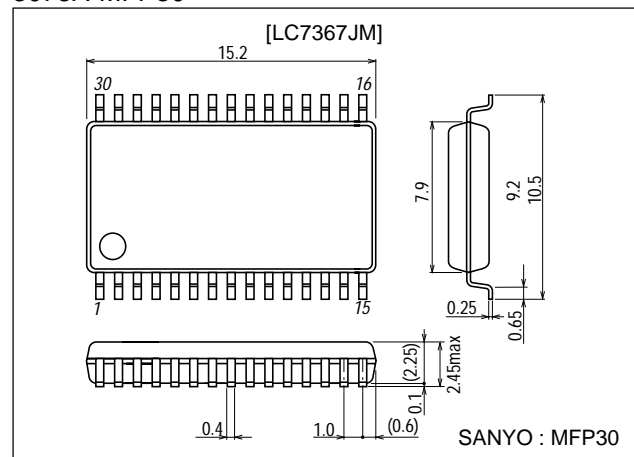

■ Any and all SANYO products described or contained herein do not have specifications that can handle applications that require extremely high levels of reliability, such as life-support systems, aircraft's control systems, or other applications whose failure can be reasonably expected to result in serious physical and/or material damage. Consult with your SANYO representative nearest you before using any SANYO products described or contained herein in such applications.

■ SANYO assumes no responsibility for equipment failures that result from using products at values that exceed, even momentarily, rated values (such as maximum ratings, operating condition ranges, or other parameters) listed in products specifications of any and all SANYO products described or contained herein.

**SANYO Electric Co., Ltd. Semiconductor Company**

TOKYO OFFICE Tokyo Bldg., 1-10, 1 Chome, Ueno, Taito-ku, TOKYO, 110-8534 JAPAN

# LC7367J, 7367JM

Continued from preceding page.

- Data retention current

$$I_{DR} \leq 0.5 \mu A / V_{DD} = 1.0V$$

- Package

LC7367J : Dual-in-line shrink 22-pin package

LC7367JM : Miniflat 30-pin package

## Pin Assignment

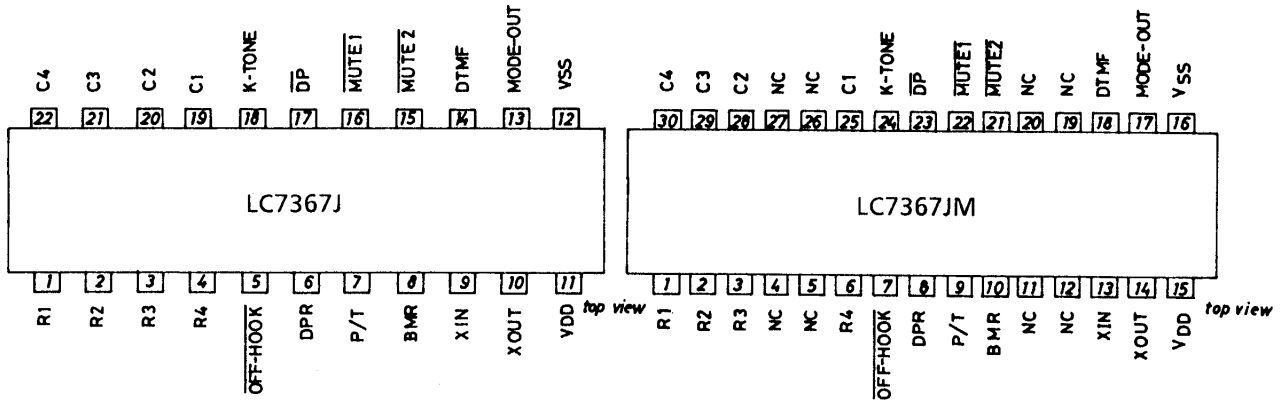

## Equivalent Circuit Block Diagram

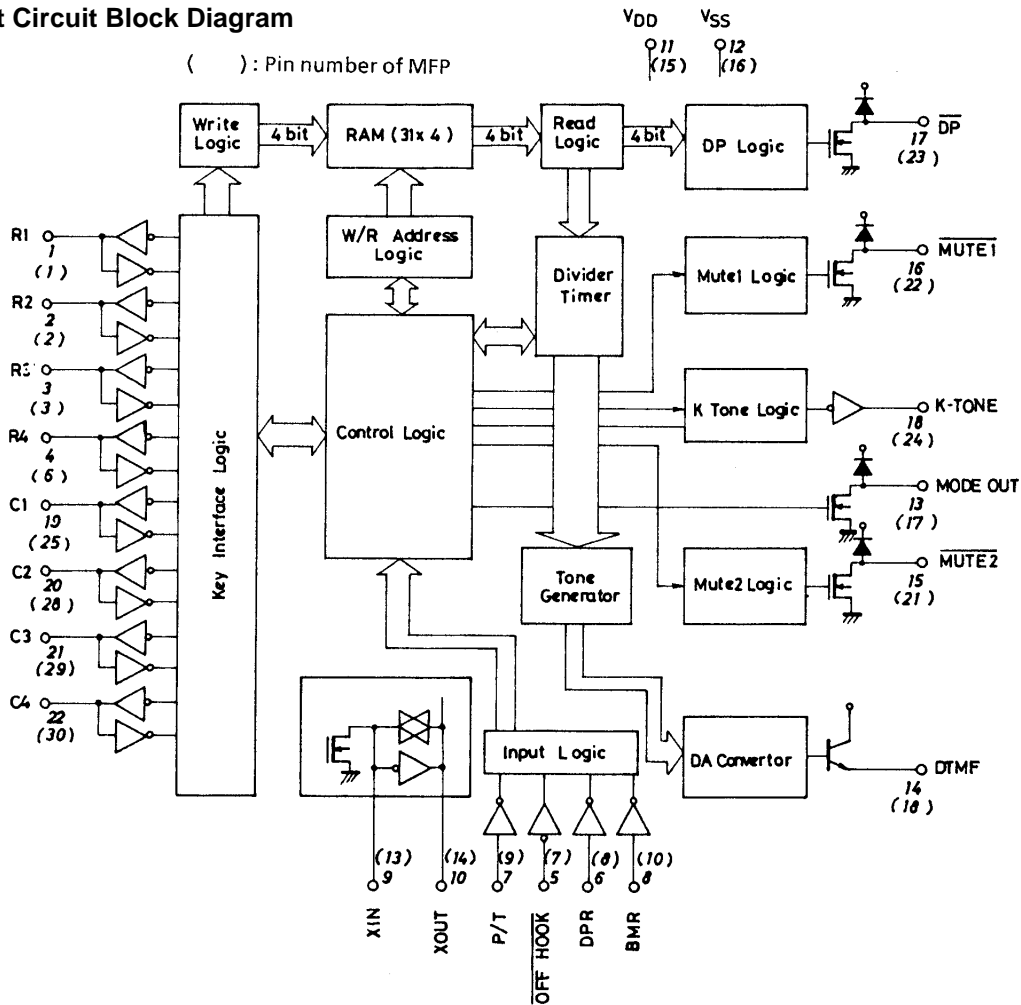

# LC7367J, 7367JM

## Pin Description ( ) : Pin number of MFP

Pin Name	Pin No.	I/O Configuration	Function
V <sub>DD</sub>	11 (15)		Power supply pin.
V <sub>SS</sub>	12 (16)		
XIN	9 (13)		Used to generate the reference frequency. Uses a crystal resonator of 3.579545MHz. With the feedback resistor and capacitors contained to form the OSC circuit, a crystal resonator is simply connected across the pins. When using a ceramic resonator, a capacitor of approximately 30pF must be connected to each pin.
XOUT	10 (14)		
R1 to R4 C1 to C4	1 to 4 22 to 19 [ 1 to 3 6 25 28 to 30 ]		Row and column input pin. High-active input. Contains a P-channel transistor for keyboard scan and an N-channel transistor for pull-down. When in the ON-HOOK state, the P-channel transistor is turned OFF and the N-channel transistor is turned ON.
OFF-HOOK	5 (7)		HOOK SW input. H-level=ON-HOOK L-level=OFF-HOOK
DPR	6 (8)		Dial pulse rate select input. H-level=20pps L-level=10pps
P/T	7 (9)		Pulse/tone select input. H-level=Pulse mode L-level=DTMF mode
BMR	8 (10)		Make rate select input. H-level=33.2% L-level=40%
DP	17 (23)		Dial pulse output.
MUTE1	16 (22)		Mute output. Operates at the OUTPUT-PULSE mode. Capable of being wired-ORed with MUTE2.
MUTE2	15 (21)		Mute output. Operates at the DTMF mode. Capable of being wired-ORed with MUTE1.
MODE-OUT	13 (17)		DTMF/OUTPUT-PULSE mode output. OUTPUT-PULSE mode=L-level DTMF mode=H-impedance
K-TONE	18 (24)		When a key is pushed at the OUTPUT-PULSE mode, the K-TONE (pacifier tone) of 1243Hz/50ms is output.
DTMF	14 (18)		The DTMF signal is output. NPN transistor-used emitter follower output.

## Key Assignment

1	2	3	F	R1
4	5	6	P	R2
7	8	9	RD	R3
✕	0	#	MC	R4
C1	C2	C3	C4	

**F** : Flash

When in OUTPUT-PULSE mode

**P** : Pause

**RD** : Redial, pause release

**✕** = **P**

**MC** : Pulse=tone select

**#** = **RD**

# LC7367J, 7367JM

## Specifications

### Absolute Maximum Ratings at Ta = 25°C

Parameter	Symbol	Conditions	Ratings	Unit
Maximum supply voltage	V <sub>DD</sub>		-0.3 to +7	V
Maximum input voltage	V <sub>IN</sub>		-0.3 to V <sub>DD</sub> +0.3	V
Maximum output voltage	V <sub>OUT</sub>		-0.3 to V <sub>DD</sub> +0.3	V
Allowable power dissipation	Pd max	Ta=70°C	300	mW
Minimum load resistance	R <sub>L</sub> min	Across DTMF and V <sub>SS</sub> pin	100	Ω
Operating temperature	Topr		-30 to +70	°C
Storage temperature	Tstg		-40 to +125	°C

### Allowable Operating Conditions at Ta = -30 to +70°C, V<sub>DD</sub>=1.5 to 6.0V

Parameter	Symbol	Conditions	Ratings			Unit
			min	typ	max	
Supply voltage	V <sub>DDP</sub>	OUTPUT-PULSE mode	1.5		6.0	V
	V <sub>DDT</sub>	DTMF mode	2.0		6.0	V
Input H-level voltage	V <sub>IH</sub>	All input pins	0.7V <sub>DD</sub>		V <sub>DD</sub>	V
Input L-level voltage	V <sub>IL</sub>	All input pins	V <sub>SS</sub>		0.3V <sub>DD</sub>	V
Key contact resistance	R <sub>KI</sub>				3.0	kΩ
Keyboard capacitance	C <sub>KI</sub>				330	pF
Resonator specification	f		3.579545MHz ±0.7%			
	RS		<100Ω			

### Electrical Characteristics at Ta = 25°C, V<sub>DD</sub>=1.5 to 6.0V

Parameter	Symbol	Conditions	Ratings			Unit
			min	typ	max	
Operating current	I <sub>DDP</sub>	OUTPUT-PULSE mode, output open, V <sub>DD</sub> =3.5V		0.3	0.5	mA
	I <sub>DDT</sub>	DTMF mode, output open, V <sub>DD</sub> =3.5V		0.5	1.0	mA
Quiescent Current	I <sub>DD(ST)</sub>	OFF-HOOK pin=V <sub>DD</sub> , V <sub>DD</sub> =1.5 to 6.0V, output open			1	μA
Data retention voltage	V <sub>DR</sub>				1	V
Data retention current	I <sub>DR</sub>	V <sub>DD</sub> =1V			0.5	μA
Input H-level current	I <sub>IH</sub>	(OFF-HOOK, DPR, P/T, BMR) pin, V <sub>IH</sub> =V <sub>DD</sub>			1	μA
Input L-level current	I <sub>IL</sub>	(OFF-HOOK, DPR, P/T, BMR) pin, V <sub>IL</sub> =V <sub>SS</sub>	-1			μA
Key pin current	I <sub>IHK</sub>	V <sub>DD</sub> =1.5V, V <sub>IH</sub> =V <sub>DD</sub>			20	μA
		V <sub>DD</sub> =6.0V, V <sub>IH</sub> =V <sub>DD</sub>			300	μA
	I <sub>OHK</sub>	V <sub>DD</sub> =1.5V, V <sub>OH</sub> =0.8V <sub>DD</sub>			-50	μA
		V <sub>DD</sub> =6.0V, V <sub>OH</sub> =0.8V <sub>DD</sub>			-700	μA
Output OFF-state leakage current	I <sub>OFF</sub>	V <sub>0</sub> =V <sub>DD</sub> , V <sub>DD</sub> =6V, output OFF, (DP, MUTE1, MUTE2, MODE-OUT)			1	μA
Output H-level pin voltage	V <sub>OH</sub>	K-TONE : V <sub>DD</sub> =1.5V, I <sub>OH</sub> =-125μA	V <sub>DD</sub> -0.5			V
		K-TONE : V <sub>DD</sub> =3.5V, I <sub>OH</sub> =-500μA	V <sub>DD</sub> -1			V
Output L-level pin voltage	V <sub>OL</sub>	(K-TONE, DP, MUTE1, MUTE2, MODE-OUT pin) : V <sub>DD</sub> =1.5V, I <sub>OL</sub> =125μA			0.4	V
		(K-TONE, DP, MUTE1, MUTE2, MODE-OUT pin) : V <sub>DD</sub> =3.5V, I <sub>OL</sub> =500μA			0.4	V

### AC Characteristics at Ta = 25°C, V<sub>DD</sub>=1.5 to 6.0V, f<sub>OSC</sub>=3.579545MHz

Parameter	Symbol	Conditions	Ratings			Unit
			min	typ	max	
Key debounce time	T <sub>KD</sub>		10.8		11.6	ms
K-TONE frequency	f <sub>KT</sub>			1243		Hz
K-TONE output time	T <sub>KT</sub>			50.9		ms
Auto pause time	T <sub>AP</sub>			3.99		s
Single tone output	V <sub>OR</sub>	ROW TONE output, V <sub>DD</sub> =3.5V, R <sub>L</sub> =10kΩ	170	205	245	mVrms
Tone output ratio	d <sub>BCR</sub>	V <sub>DD</sub> =2 to 6V, R <sub>L</sub> =10kΩ	1	2	3	dB
Tone output distortion	%DIS	V <sub>DD</sub> =2.5 to 6V, R <sub>L</sub> =10kΩ, f=300 to 3400Hz			7	%
		V <sub>DD</sub> =2 to 6V, R <sub>L</sub> =10kΩ, f=300 to 3400Hz			10	%
Oscillation start time	T <sub>START</sub>	V <sub>DD</sub> =1.7 to 6V			20	ms
		V <sub>DD</sub> =3.5V			8	ms
DTMF output time	T <sub>MFO</sub>		97.6			ms
DTMF interdigit pause	T <sub>MFOFF</sub>		100.6			ms
Flash time	T <sub>FLASH</sub>			605		ms

# LC7367J, 7367JM

## • Dial Pulse Output

fosc=3.579545MHz

Pin DPR	Pin BMR	Dial Pulse Rate	Interdigit Pause	Make Ratio
VSS	VDD	9.94PPS	838.1ms	33.2%
VDD	VDD	19.89PPS	519.6ms	33.2%
VSS	VSS	9.94PPS	844.8ms	40%
VDD	VSS	19.89PPS	523.0ms	40%

## • DTMF Output

fosc=3.579545MHz

Input	Output Frequency (Hz)		Deviation (%)
	Standard	LC7367J, 7367JM	
R1	697	699.1	+0.30
R2	770	766.2	-0.49
R3	852	847.4	-0.54
R4	941	948.0	+0.74
C1	1209	1215.9	+0.57
C2	1336	1331.7	-0.32
C3	1477	1471.9	-0.35

## • Redial Operation

fosc=3.579545MHz

Parameter	Time	
	1st Digit	2nd Digit onward
DTMF Output	97.6ms	100.6ms
Interdigit Pause	100.6ms	100.6ms
Period	198.2ms	201.2ms

## Timing Charts

### (1) OUTPUT-PULSE mode

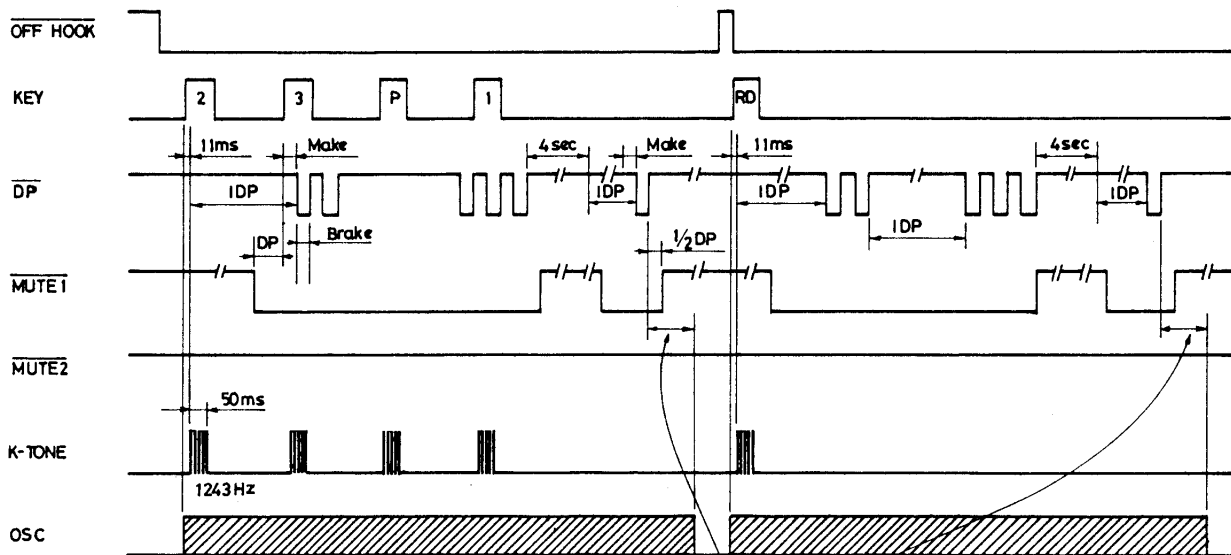

$$800 - \left(1 - \frac{10}{DP}\right) \times 600 + \frac{\text{Make ratio}}{DP} \times 10 + DP \quad (\text{ms})$$

$$DP = \frac{1000}{DPR} \quad (\text{ms})$$

# LC7367J, 7367JM

## (2) Tone mode

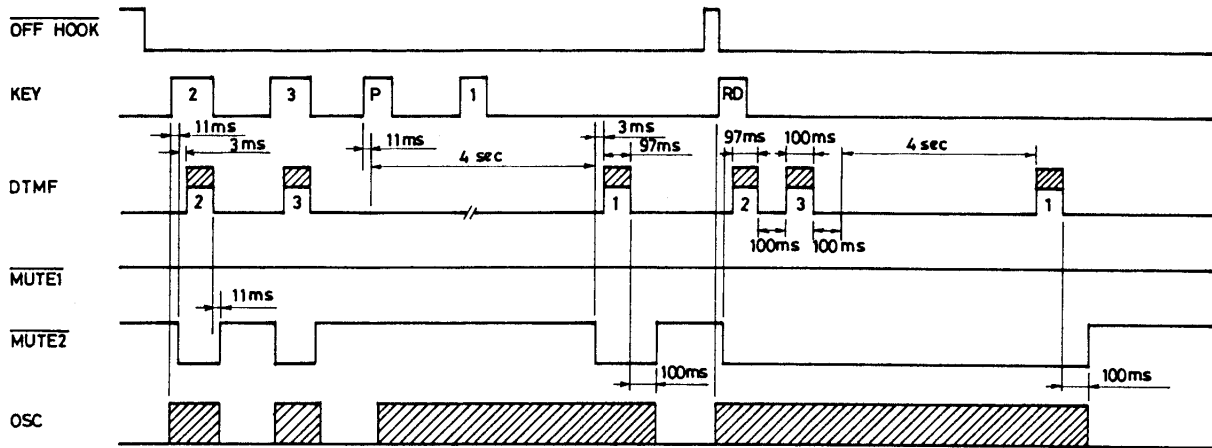

## (3) Pulse → tone mix (P/T='H')

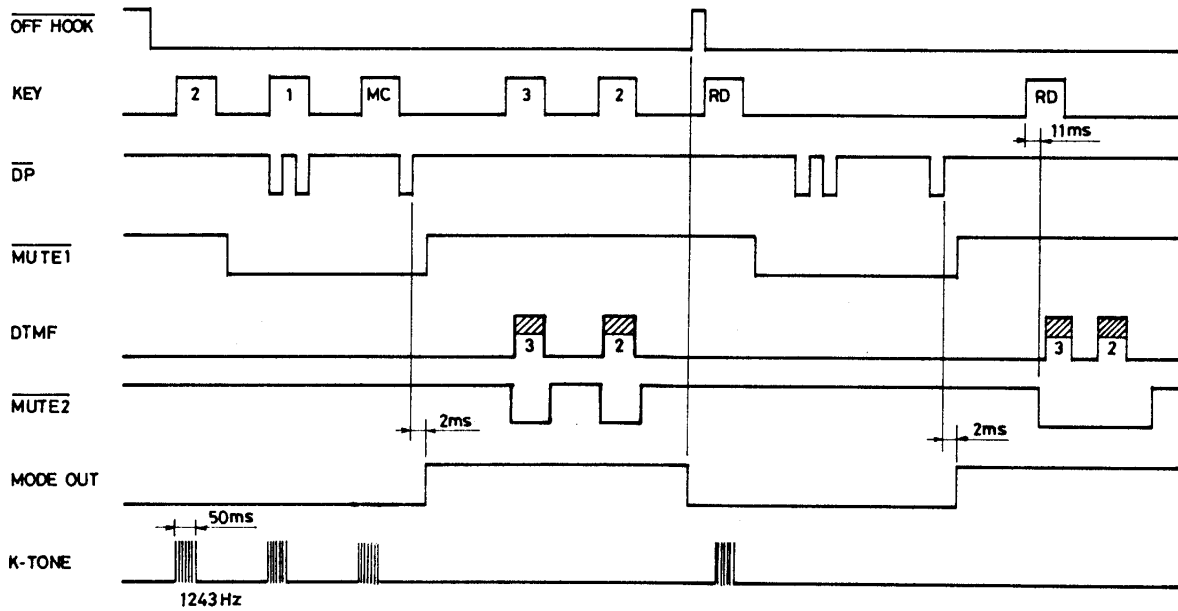

## (4) Pulse → tone (P/T='H')

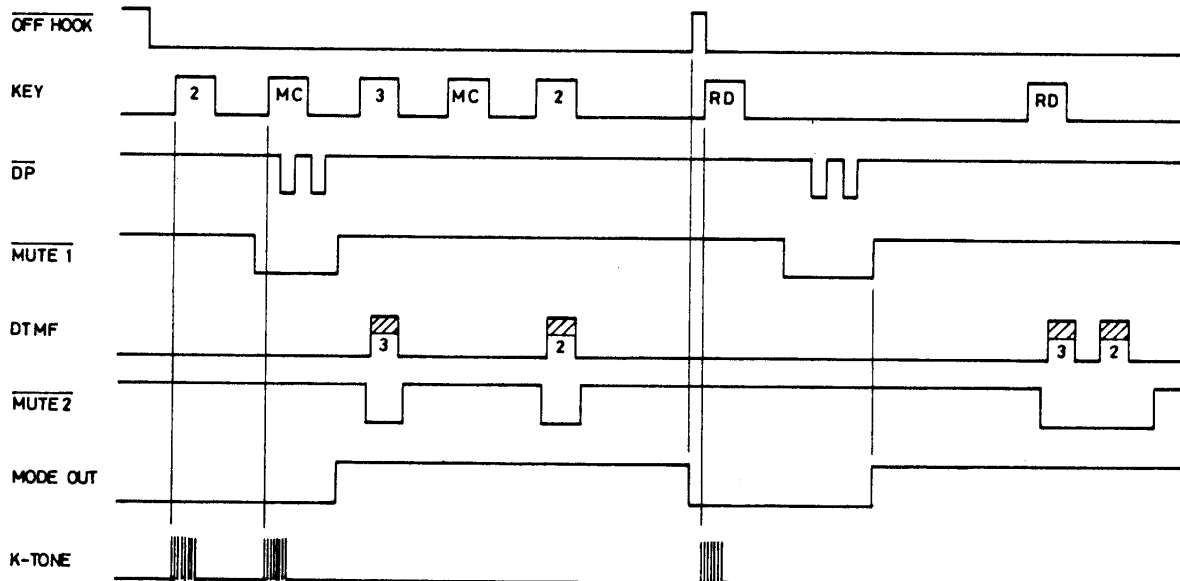

2nd MC key-in is invalid.

# LC7367J, 7367JM

## (5) Timing of flash

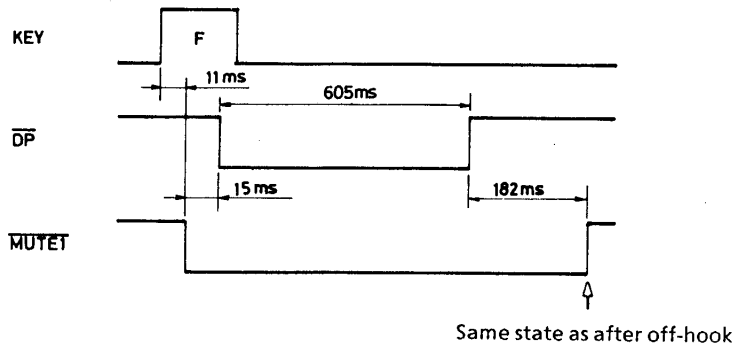

## (6) Mix dial and redial (key entry available after redial) by P/T input (slide SW, stc.)

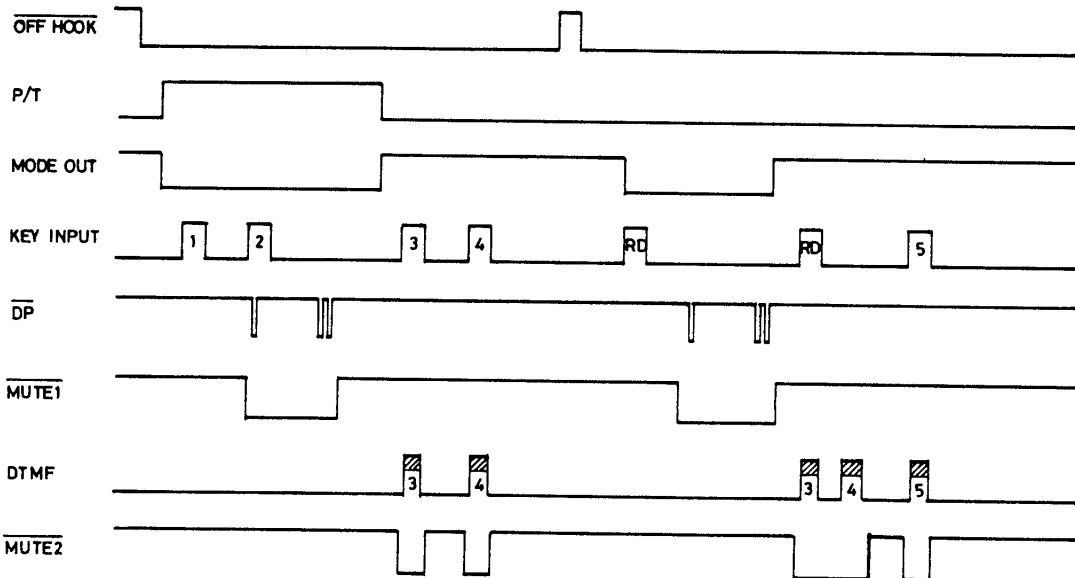

- Even when the tone mode (P/T SW : "Tone") is entered at the OFF-HOOK state, the OUTPUT-PULSE mode can be entered (P/T SW : "Pulse").
- The output mode provided when redialing is the one provided when dialed previously (regardless of the P/T SW position when the RD key is pushed).

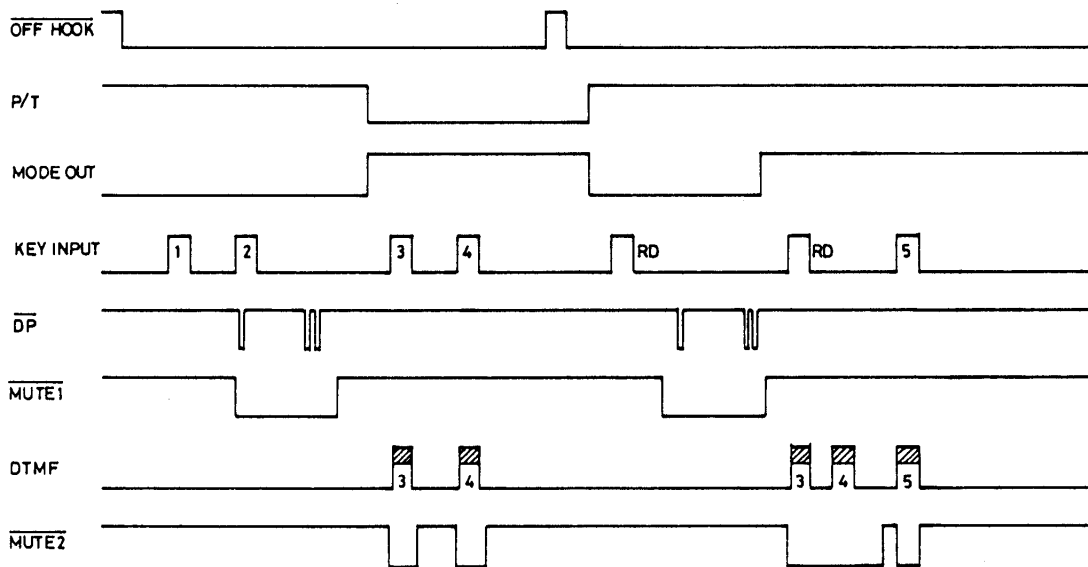

- The mode after completion of redialing is set again by the P/T SW position provided when redialing is completed.

Since the DP, MUTE1, MUTE2, MODE-OUT outputs are of the Nch open drain type, the output transistor OFF-state (H-impedance) provides H-level.

Likewise, since the DTMF output is of the emitter follower type, the output transistor OFF-state (H-impedance) provides L-level.

**Key Operation**

(1) Normal dial

Off-hook → [D1] [D2] . . . . [Dn]

Redial

Off-hook → [RD]

(2) PBX dial

Off-hook → [D0] [P] [D1] [D2] . . . . [Dn]

Redial

Off-hook → [RD]

(3) Pulse/tone mix

① In case where there is no pause during mode select.

Off-hook → [D1] [D2] [MC] [D3] [D4] (P/T=H)

Redial ← pulse → ← Tone →

Off-hook → [RD] ← D1, D2 Pulse → [RD] ← D3, D4 Tone →

② In case where there are pauses during mode select.

Off-hook → [D1] [D2] [P] [MC] [D3] [D4] (P/T=H)

Redial ← pulse → ← Tone →

Off-hook → [RD] ← D1, D2 <sup>4sec</sup> Pause → [RD] ← D3, D4 Tone →

- (Note) ① When in OUTPUT-PULSE mode [P] = [X] [RD] = [#]  
 ② Pause : 4s. / 1 push of [P] , 8s. / 2 pushes of [P] , 4×ns. / n pushes of [P]  
 ③ For pause release, push [RD]. All pauses can be also released by pushing [RD] once.

**Function Specifications**

The LC7367J, 7367JM are capable of pulse dial, DTMF dial and also both types of dialing mixed, as well as redial of these.

1) Dial Output Specifications

- The output pulse make ratio of OUT-PULSE mode can be set at 33.2 or 40% using the BMR pin.
- The output pulse rate of OUT-PULSE mode can be set at 20 or 10pps using the DPR pin.
- 12 types of DTMF dial signals (1 to 0, \*, #) are generated in DTMF mode.
- DTMF signals are output continuously when the keys are pressed.
- A minimum output for DTMF of approximately 100ms, and also about 100ms for minimum IDP are guaranteed.

2) Summary of Operation

- Key input data is written consecutively in the 31 digit buffer memory (also used as RD memory ; hereinafter referred to as RD memory).
- The dial data in the RD memory is read out according to the set dial rate, and is output at the  $\overline{DP}$  and DTMF pins.
- Dial output of more than 31 digits is enabled by rewriting the key data from the top (address 0) of the RD memory.
- Because of this, the correct dial does not remain in the RD memory for 32 digits or more, so redial for 32 digits or more is prohibited.
- Dial data (1 to 0, \*, #), mode change data (MC) and pause data (P) are written in the RD memory as 1 digit each.
- Dial output mode switching can be performed using the MC key on the key matrix or the P/T input pin.
- The dial output can be stopped for 4 seconds with the pause key (P).
- One-touch redial can be done using the redial key (RD).

Continued on next page.



Continued from preceding page.

3) Key and P/T Pin Descriptions

① Keys 1 to 0

These are dial data keys. Data is written in the RD memory.

② ✕, # Keys

In DTMF mode : ✕ and # dial data key

In OUT-PULSE mode : ✕ = pause key (P)

# = redial key (RD)

The ✕ and # keys for DTMF mode and ✕ key in the OUT-PULSE mode are for writing data in the RD memory.

③ F Key (flash key)

· The same operation as for 0.6-second hooking is performed when  $\overline{DP}$  output is turned on for 0.6 second.

· Redial can be performed after flash operation.

④ RD Key (redial key)

1. Redial operation

When the RD key is pressed after hooking ( $\overline{OFF-HOOK}$  pin) or F key operation, the number that immediately precedes will be redialed.

Redial is prohibited if the number has 32 digits or more.

2. Pause release

The Pause key provides 4-second pause and releases pause attendant on the mode change (MC key, P/T pin).

Even if there is a succession of 2 digits or more of pause data in the RD memory, it will all be released.

∞ P Key (pause key)

· Stops dial output for 4 seconds.

· Data is written in the RD memory.

⑥ MC Key (mode change key)

· Switches dial mode from OUT-PULSE mode to DTMF mode.

· The mode cannot be switched from DTMF mode to OUT-PULSE mode.

⑦ P/T Pin

· Input to indicate dial mode

H=OUT-PULSE mode

L=DTMF (tone) mode

· The mode can be switched between DTMF and pulse mode differ from in case of MC key.

· Mix dialing by P/T pin switching during dialing is possible. MD data is written in the RD memory at this time.

· At OUT-PULSE mode, if the MC key is pressed during dialing, data is written in the RD memory as MC data.

· At OUT-PULSE mode, pressing the first digit (after OFF-HOOK) MC key switches the dial mode, but data is not written in the RD memory.

Key Assignment

	C1	C2	C3	C4
R1	1	2	3	F
R2	4	5	6	P
R3	7	8	9	RD
R4	✕	0	#	MC

Key Debounce Time

- A key debounce circuit is built in key input to prevent misoperation caused by switch chattering.

Input is valid when on continuously for 11ms or more,  
and is invalid when off continuously for 11ms or more.

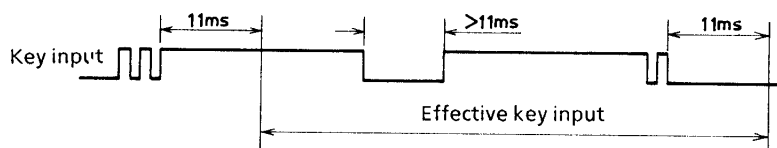

4) MC Data Writing in RD Memory

- After the MC data is stored once in the MC data flag, it is written in the RD memory when another data key (1 to 0, \*, #, P) is pressed.
- The MC data flag is reset with hooking and the P key.
- The contents of the MC data flag are canceled and are not written in the RD memory when the P/T pin is switched as P → T → P.

5) Notes on Dial Specifications

① Pause operation during mode switching

When there is no P data before or after MC data.

1. Normal dial

Mode change is done and DTMF data key is started during dial pulse output :

→ After dial pulse ends, pause begins, and the DTMF signal is output with release using the RD key.

DTMF data keyed in after dial pulse output :

→ DTMF signal is output with key-in.

2. Redial for the above

After dial pulse ends, pause begins, and the DTMF signal is output with release using the RD key.

② Key input during redial

This is ignored except for the F key and the RD key during pause operation.

6) Test Mode

A high speed test mode is provided in order to reduce the IC test time.

- Test mode setting and release methods

BMR pin input

OFF-HOOK pin input

+ built-in power-on reset pulse

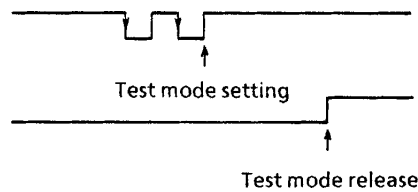

- Test mode summary

The internal divider circuit (72 divisions) is bypassed.

Key scan frequency ..... 72 times

Dial pulse rate ..... 72 times

4-second pause ..... 1/72

# LC7367J, 7367JM

## Sample Application Circuit

(Pin numbers are for DIP package)

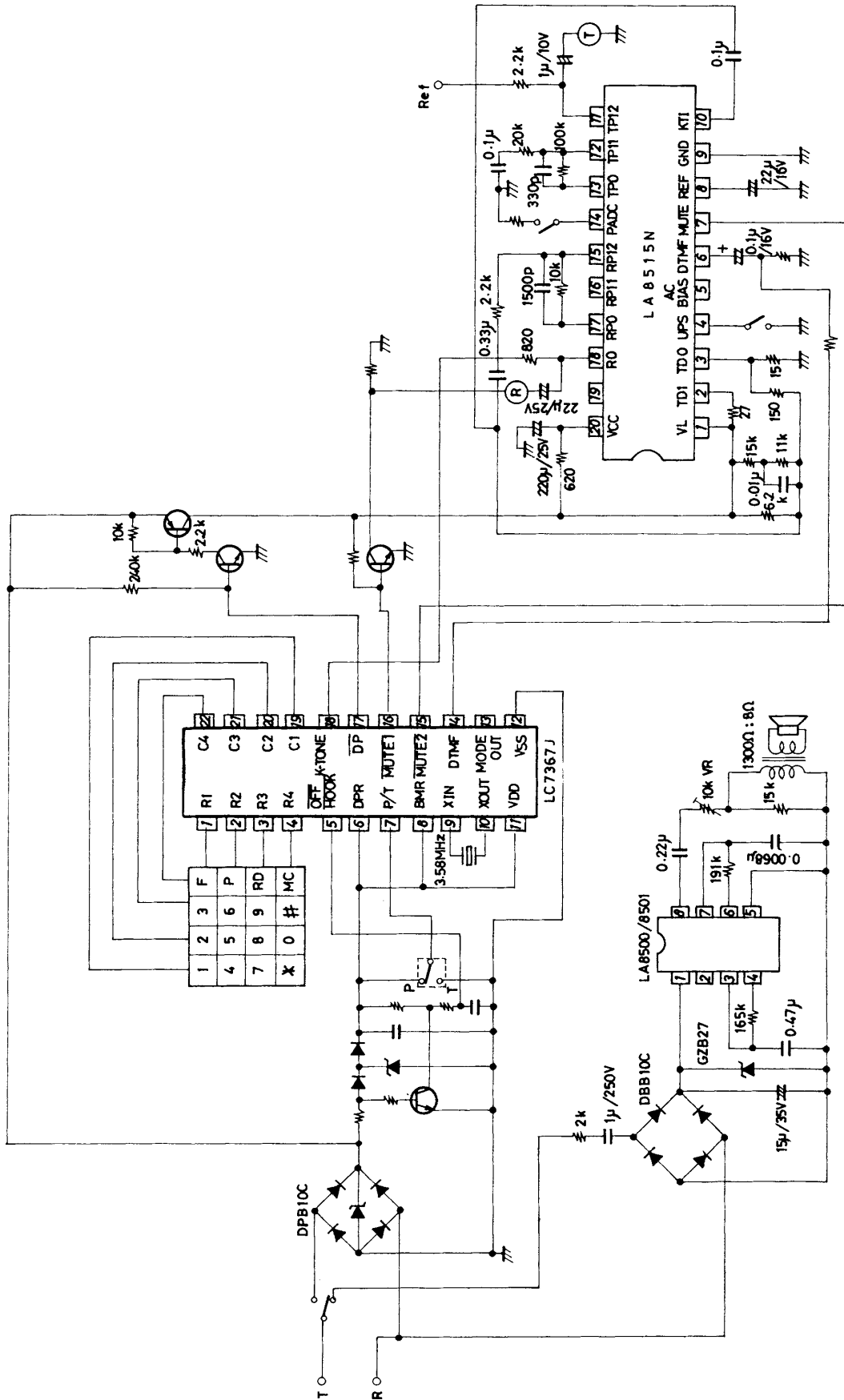

Unit (resistance : Ω, capacitance : F)

- Specifications of any and all SANYO products described or contained herein stipulate the performance, characteristics, and functions of the described products in the independent state, and are not guarantees of the performance, characteristics, and functions of the described products as mounted in the customer's products or equipment. To verify symptoms and states that cannot be evaluated in an independent device, the customer should always evaluate and test devices mounted in the customer's products or equipment.
- SANYO Electric Co., Ltd. strives to supply high-quality high-reliability products. However, any and all semiconductor products fail with some probability. It is possible that these probabilistic failures could give rise to accidents or events that could endanger human lives, that could give rise to smoke or fire, or that could cause damage to other property. When designing equipment, adopt safety measures so that these kinds of accidents or events cannot occur. Such measures include but are not limited to protective circuits and error prevention circuits for safe design, redundant design, and structural design.
- In the event that any or all SANYO products(including technical data, services) described or contained herein are controlled under any of applicable local export control laws and regulations, such products must not be exported without obtaining the export license from the authorities concerned in accordance with the above law.
- No part of this publication may be reproduced or transmitted in any form or by any means, electronic or mechanical, including photocopying and recording, or any information storage or retrieval system, or otherwise, without the prior written permission of SANYO Electric Co., Ltd.
- Any and all information described or contained herein are subject to change without notice due to product/technology improvement, etc. When designing equipment, refer to the "Delivery Specification" for the SANYO product that you intend to use.
- Information (including circuit diagrams and circuit parameters) herein is for example only ; it is not guaranteed for volume production. SANYO believes information herein is accurate and reliable, but no guarantees are made or implied regarding its use or any infringements of intellectual property rights or other rights of third parties.

This catalog provides information as of May, 2001. Specifications and information herein are subject to change without notice.