

**SANYO**

No. 3861

**LC78840M****Four-times or Eight-times Oversampling  
Digital Filter****OVERVIEW**

The LC78840M is a four-times or eight-times oversampling digital filter for Broadcast Satellite (BS), Compact Disc (CD) and Digital Audio Tape (DAT) applications. The filter operates at 384fs, 392fs or 512fs, and has internal deemphasis for  $f_s = 32, 44.1$  or 48 kHz. Output data length is 18 or 16 bits for eight-times or four-times oversampling, respectively.

The LC78840M features a double-rate mode for dubbing CDs to cassette tape, where the data rate is doubled and the data is processed with half the oversampling of normal-rate mode. An external controller can be used to set the rate mode, output offset, deemphasis and attenuation.

The LC78840M operates from a 5 V supply and is available in 24-pin MFPs.

**FEATURES**

- Four-times or eight-times oversampling
- 384fs, 392fs and 512fs operation
- Double-rate compatible
- Selectable deemphasis
- Digital attenuator
- Optional output offset
- Two input and output formats
- 5 V supply
- 24-pin MFP

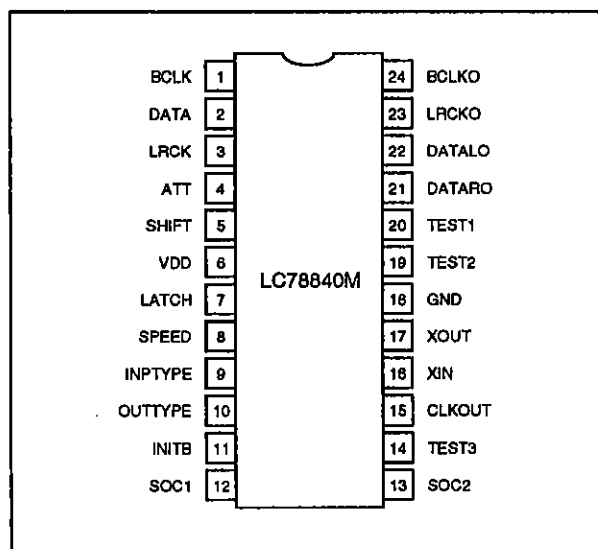
**PINOUT****PACKAGE DIMENSIONS**

Unit: mm

3155-MFP24

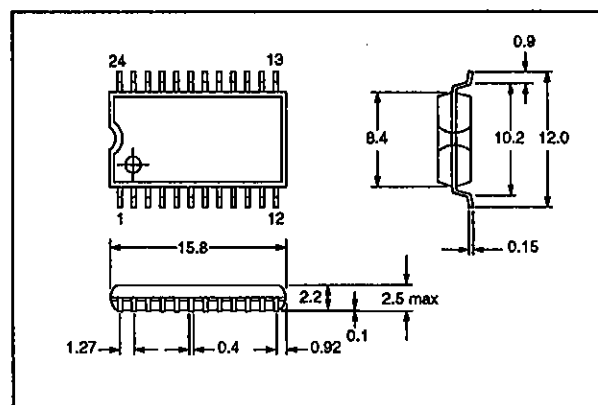

## PIN DESCRIPTION

Number	Name	Description
1	BCLK	Bit-clock input
2	DATA	Digital audio data input
3	LRCK	LR clock input
4	ATT	Attenuation data input. Normal/double-rate select in external set mode
5	SHIFT	Attenuation data shift clock input. Deemphasis select input in external set mode
6	VDD	5 V supply
7	LATCH	Attenuation data latch clock input. Deemphasis select input in external set mode
8	SPEED	Four- or eight-times oversampling select input
9	INPTYPE	Input format select input
10	OUTTYPE	Output format select input
11	INITB	Initialization input
12	SOC1	Input source and external set mode select input 1
13	SOC2	Input source and external set mode select input 2
14	TEST3	Test input 3
15	CLKOUT	Clock output
16	XIN	Crystal oscillator input
17	XOUT	Crystal oscillator output
18	GND	Ground
19	TEST2	Test input 2. Input source select 2 in external set mode
20	TEST1	Test input 1. Input source select 1 in external set mode
21	DATARO	Right-channel data output
22	DATALO	Left- and right-channel alternating data output for four-times oversampling, and left-channel data output, for eight-times oversampling
23	LRCKO	Left- and right-channel clock output
24	BCLKO	Bit-clock output

## SPECIFICATIONS

## Absolute Maximum Ratings

Parameter	Symbol	Rating	Unit
Supply voltage range	$V_{DD}$	-0.3 to 7.0	V
Input voltage range	$V_I$	-0.3 to $V_{DD} + 0.3$	V
Output voltage range	$V_O$	-0.3 to $V_{DD} + 0.3$	V
Operating temperature range	$T_{opr}$	-30 to 75	°C
Storage temperature range	$T_{stg}$	-40 to 125	°C

## Recommended Operating Conditions

 $T_a = -30 \text{ to } 75 \text{ }^\circ\text{C}$ 

Parameter	Symbol	Rating	Unit
Supply voltage	$V_{DD}$	5	V
Supply voltage range	$V_{DD}$	4.5 to 5.5	V

## Electrical Characteristics

 $V_{DD} = 5 \text{ V}, T_a = 25 \text{ }^\circ\text{C}$ 

Parameter	Symbol	Condition	Rating			Unit
			min	typ	max	
LOW-level input voltage	$V_{IL}$		-0.3	-	0.8	V
HIGH-level input voltage	$V_{IH}$		2.2	-	$V_{DD} + 0.3$	V
LOW-level output voltage	$V_{OL}$	$I_o = \pm 4 \text{ mA}$	-	-	0.4	V
HIGH-level output voltage	$V_{OH}$	$I_o = \pm 4 \text{ mA}$	3.0	-	-	V
CLKOUT output amplitude	$V_o$	$f_x = 16.9344 \text{ MHz}$ $C_L = 20 \text{ pF}$	1	-	-	$V_{pp}$
Power consumption	$P_D$	$V_{XIN} = 1.5 \text{ to } 3.5 \text{ V}_{pp}$ $f_x = 16.9344 \text{ MHz}$	-	250	300	mW
Oscillator frequency	$f_x$		-	16.9344	25	MHz
BCLK input frequency	$f_{bcx}$		-	-	3.1	MHz
TEST1, TEST2 and TEST3 input pull-down resistance	$R_{DOWN}$		10	-	80	$k\Omega$

## Timing Characteristics

 $V_{DD} = 5 \text{ V}, T_a = 25 \text{ }^\circ\text{C}$ 

Parameter	Symbol	Condition	Rating			Unit
			min	typ	max	
BCLK input pulsewidth	$t_{wb}$		100	-	-	ns
DATA input setup time	$t_{DS}$		20	-	-	ns
DATA input hold time	$t_{DH}$		20	-	-	ns
LRCK input setup time	$t_{LRS}$		50	-	-	ns
LRCK input hold time	$t_{LRH}$		50	-	-	ns
BCLKO output pulsewidth	$t_{wBO}$	Eight-times oversampling	40	-	-	ns
DATALO and DATARO output setup time	$t_{DSO}$	$f_x = 16.9344 \text{ MHz}$	25	-	-	ns
DATALO and DATARO output hold time	$t_{DHO}$	$C_L = 50 \text{ pF}$	25	-	-	ns
Program input reference time	$t_{PR}$	$f_x = 16.9344 \text{ MHz}$	250	-	-	ns
LATCH input pulsewidth	$t_{WLT}$	$f_x = 16.9344 \text{ MHz}$	50	-	-	ns
SHIFT and LATCH rise time	$t_r$		-	-	200	ns
SHIFT and LATCH fall time	$t_f$		-	-	200	ns

# LC78840M

Parameter	Symbol	Condition	Rating			Unit
			min	typ	max	
ATT input setup time	$t_{SET}$		500	–	–	ns
ATT input hold time	$t_{HOLD}$		500	–	–	ns
Interval time	$t_{INT}$		1000	–	–	ns

## Audio Input

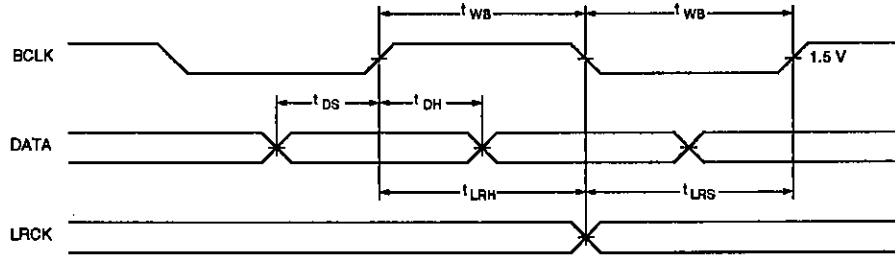

## Audio output

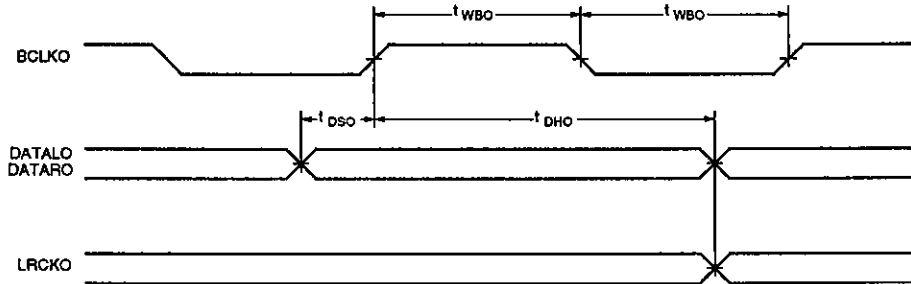

## Program input

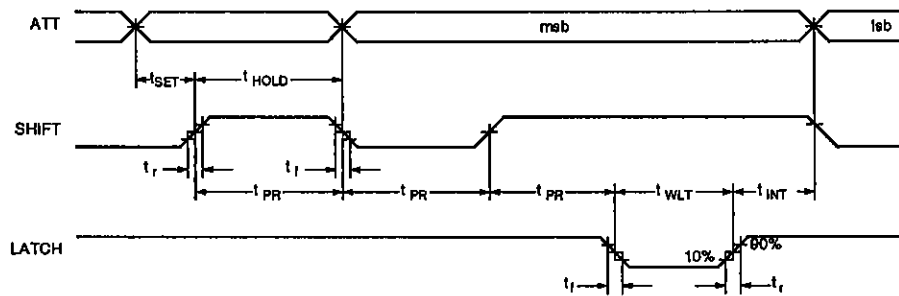

**Theoretical Filter Response**

**Normal-rate mode with eight-times oversampling**

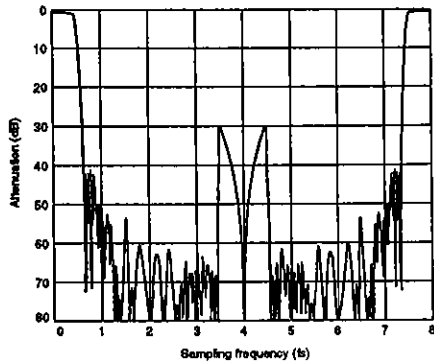

**Normal-rate mode with four-times oversampling**

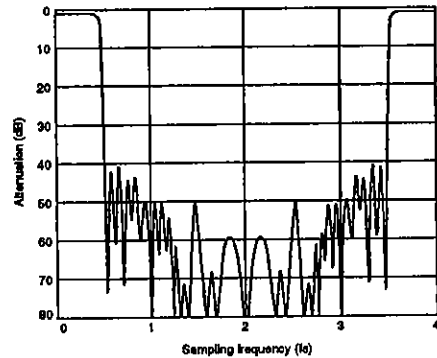

**Double-rate mode with eight-times oversampling**

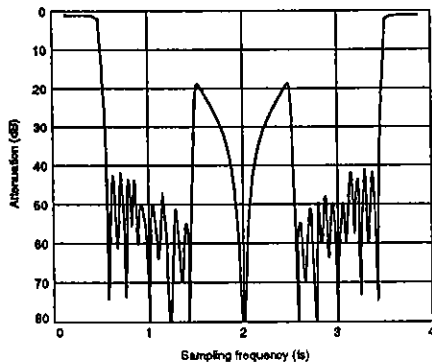

**Double-rate mode with four-times oversampling**

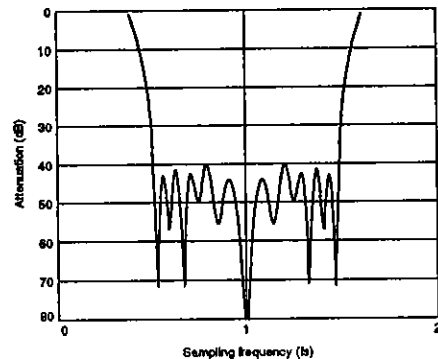

**FUNCTIONAL DESCRIPTION**

**Eight-times Oversampling**

In normal-rate mode, 43rd-order, 11th-order and 3rd-order FIR filters are used to successively generate data with two-times, four-times and eight-times oversampling, respectively, as shown in figure 1.

Deemphasis is performed by the 1st-order IIR filter. The least significant 4 bits of the 22-bit internal data are used for noise shaping. The output data length is 18 bits.

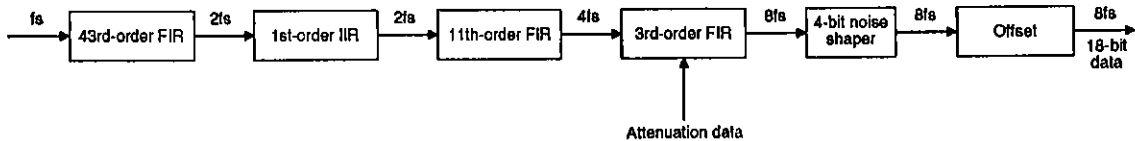

Figure 1. Normal-rate mode eight-times oversampling filter

**Note**

The offset is set ON or OFF by bit A0 of the input attenuation data. It adds 02AAH to the output data.

In double-rate mode, the filter operation is similar except that the 11th-order FIR filter is omitted, resulting

in output data with four-times oversampling as shown in figure 2.

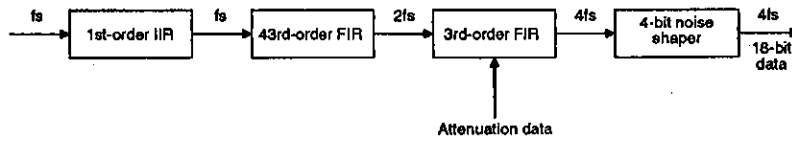

Figure 2. Double-rate mode eight-times oversampling filter

**Note**

fs is the double-rate input frequency.

**Four-times Oversampling**

In normal-rate mode, 43rd- and 11th-order FIR filters are used to successively generate data with two-times and four-times oversampling, respectively, as shown in figure 3.

Deemphasis is performed by the 1st-order IIR filter. The least significant 6 bits of the 22-bit internal data are used for noise-shaping. The output data length is 16 bits.

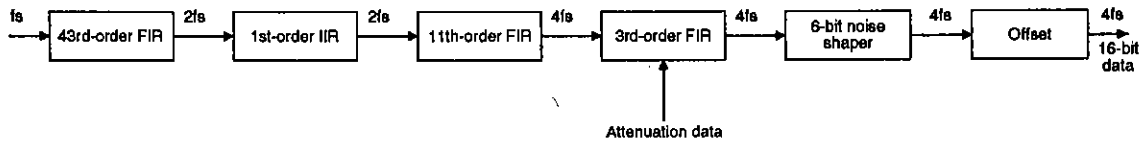

Figure 3. Normal-rate mode four-times oversampling filter

In double-rate mode, the filter operation is similar except that the 11th-order filter is omitted, resulting in

output data with two-times oversampling as shown in figure 4.

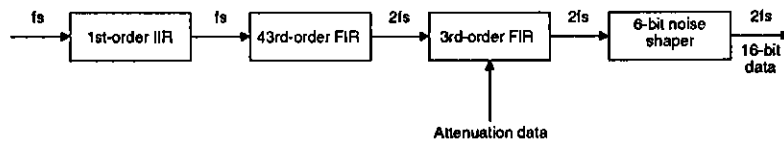

Figure 4. Double-rate mode four-times oversampling filter

**Note**

fs is the double-rate input frequency.

**Initialization**

Initialization is required at power-on and when the input source is changed. At initialization, the LC78840M requires XIN, BCLK and LRCK, stable VDD, and INITB set LOW for more than one cycle of LRCK, as shown in

figure 5. Note that the LC78840M should be re-initialized if the input data format fails. This may occur during channel selection if LRCK slips out of phase or if the digital input phase relationships change.

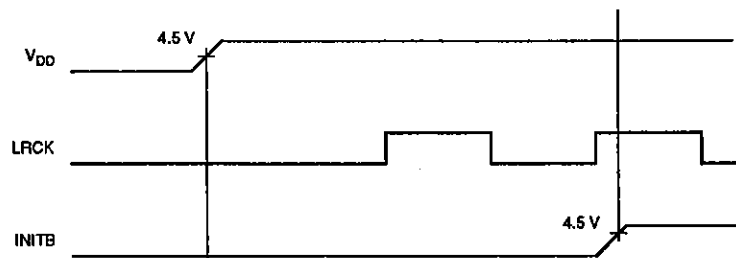

Figure 5. Initialization waveform

**Pin Functions**

**SPEED**

Set **SPEED** LOW for eight-times oversampling, or HIGH, for four-times oversampling.

**INPTYPE**

Set **INPTYPE** LOW for input data format A, or HIGH, for format B.

**OUTTYPE**

Set **OUTTYPE** LOW for output data format A, or HIGH, for format B.

**TEST1, TEST2 and TEST3**

These inputs have internal pull-down resistors and are normally LOW. In external set mode, **TEST1** and **TEST2** select the input source.

**SOC1 and SOC2**

The input sources selected by **SOC1** and **SOC2** are shown in table 1. External set mode is selected when both inputs are HIGH.

**External Set Mode**

In this mode, the **ATT** data is not used. Instead, the selection of input source, deemphasis and normal- or double-rate is by the logic level controls on inputs, shown in tables 2 to 5.

Table 2. External set inputs

Input pin	Function
TEST1 TEST2	Selects input source in place of SOC1 and SOC2. See table 3.
ATT	Selects rate mode. See table 4.
SHIFT LATCH	Selects deemphasis. See table 5.

Table 5. SHIFT and LATCH deemphasis select

SHIFT	LATCH	Deemphasis	Sampling frequency	Application
LOW	LOW	OFF	-	-
LOW	HIGH	ON	$f_s = 32 \text{ kHz}$	BS, DAT
HIGH	LOW	ON	$f_s = 44.1 \text{ kHz}$	CD
HIGH	HIGH	ON	$f_s = 48 \text{ kHz}$	BS, DAT

Table 1. SOC1 and SOC2 modes

SOC1	SOC2	Function	Input source
LOW	LOW	Input source select	384fs
LOW	HIGH		392fs
HIGH	LOW		512fs
HIGH	HIGH	External set mode	-

**CLKOUT**

The output frequency is  $0.5f_x$  for a 392fs input source, or  $0.25f_x$ , for 384fs or 512fs input sources.

**DATARO and DATALO**

In eight-times oversampling mode, right-channel and left-channel data is output on **DATARO** and **DATALO**, respectively. In four-times oversampling mode, left-channel and right-channel data is output alternately on **DATALO**, and right-channel data only is output on **DATARO**.

Table 3. TEST1 and TEST2 input source select

TEST1	TEST2	Input source
LOW	LOW	384fs
LOW	HIGH	392fs
HIGH	LOW	512fs

Table 4. ATT rate mode select

ATT	Rate mode
LOW	Normal rate
HIGH	Double rate

**OPERATING INFORMATION**

The input and output data formats for four- and eight-times oversampling are shown in figures 6 to 10. Data

input and output take 48, 49 or 64 bit-clock periods for 384fs, 392fs or 512fs operation, respectively.

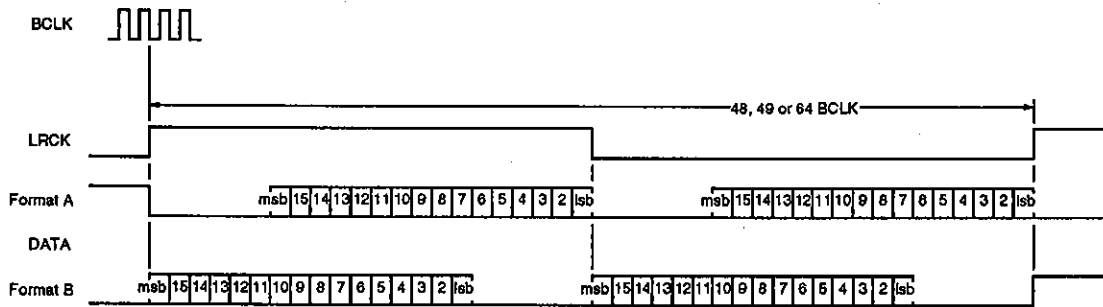

Figure 6. Input data format

**Note**

For 392fs operation, the LRCK mark-space ratio can be 24:25 or 25:24.

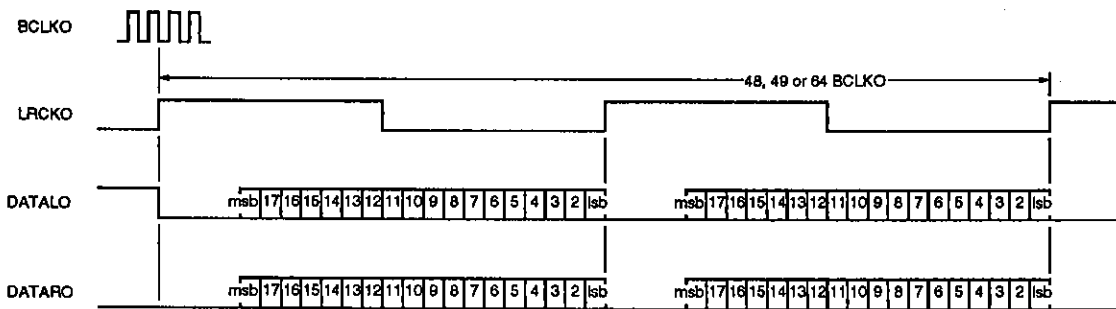

Figure 7. Eight-times oversampling, format A output data format

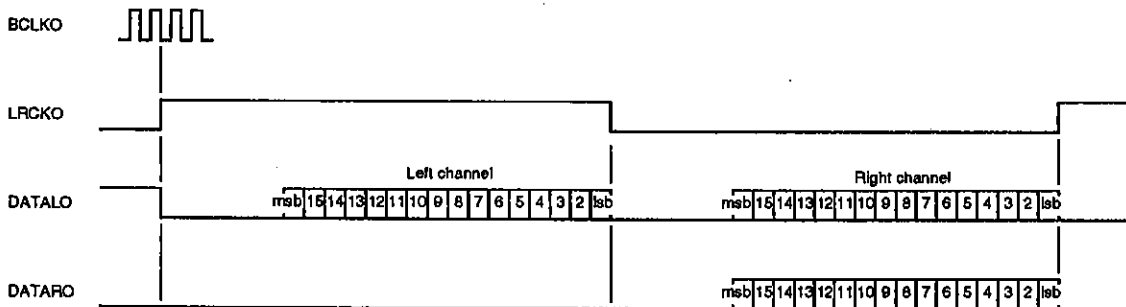

Figure 8. Four-times oversampling, format A output data format



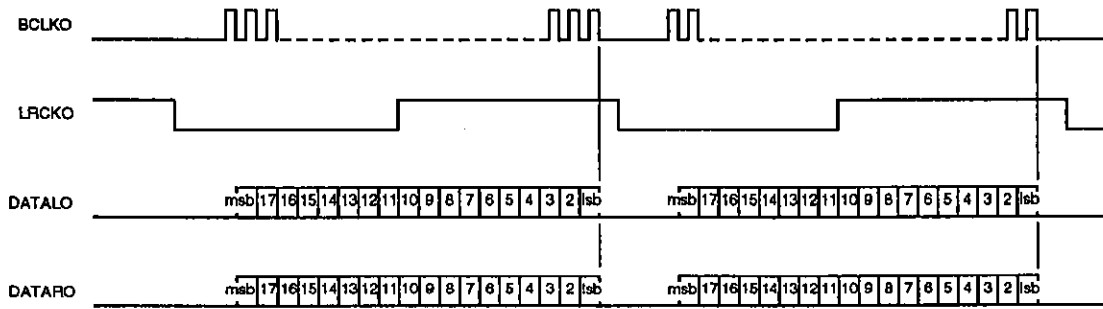

Figure 9. Eight-times oversampling, format B output data format

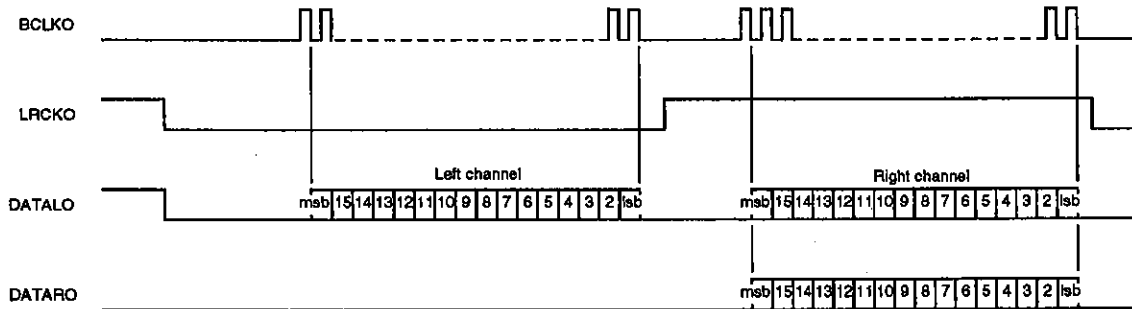

Figure 10. Four-times oversampling, format B output data format

**Notes**

1. The delay from data output to LRCKO is one BCLKO period.
2. For 392fs operation with 8-times oversampling, LRCKO has opposite phase for both A and B output formats.

**DESIGN INFORMATION**

**ATT Data Format**

Normal-rate or double-rate mode, deemphasis and filter attenuation can be set by data input on ATT. The data

format is shown in figure 11. At initialization, the ATT register data is set to 4000H.

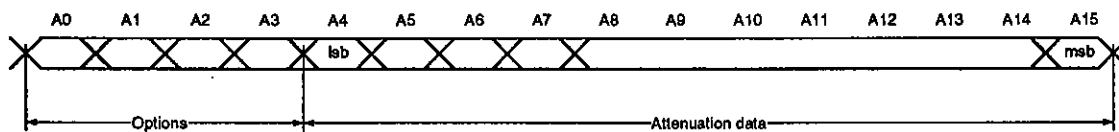

Figure 11. ATT data format

**Attenuation data (A15 to A4)**

A15 to A6 are the 10-bit attenuator multiplier coefficient, where the attenuation is given by the following equation.

$$\alpha_{\text{multiplier}} = 20 \times \log \left( \frac{A15 \text{ to } A6}{256} \right) \text{ dB}$$

When A15 to A6 are all 0, A5 and A4 set further attenuation using a barrel shifter. The attenuation levels are shown in table 6.

Table 6. Attenuation levels

ATT attenuation data												Attenuation (dB)
A15	A14	A13	A12	A11	A10	A9	A8	A7	A6	A5	A4	
0	1	0	0	0	0	0	0	0	0	0	0	0
0	0	1	1	1	1	1	1	1	1	1	1	1
0	0	1	1	1	1	1	1	1	1	1	0	1
0	0	1	1	1	1	1	1	1	1	0	0	1
0	0	1	1	1	1	1	1	1	1	0	0	0
0	0	1	1	1	1	1	1	1	0	1	1	1
0	0	1	1	1	1	1	1	1	0	1	0	1
↓	↓	↓	↓	↓	↓	↓	↓	↓	↓	↓	↓	↓
0	0	0	0	0	0	0	0	0	0	1	0	0
0	0	0	0	0	0	0	0	0	0	0	1	1
0	0	0	0	0	0	0	0	0	0	0	1	0
0	0	0	0	0	0	0	0	0	0	0	0	1
0	0	0	0	0	0	0	0	0	0	0	0	0

When the attenuation data is changed from 400H to 000H, the LC78840M performs software mute and ramps to infinite attenuation in 1024/fs seconds.

**Options (A3 to A0)**

A1 is the speed flag. When A1 = 0, normal-rate mode is selected, and when A1 = 1, double-rate mode is selected.

A2 and A3 select the deemphasis setting, as shown in table 7.

A0 is the offset flag. When A0 = 0, no offset is selected.

Table 7. A2 and A3 deemphasis select

A2	A3	Deemphasis	Sampling frequency	Application
0	0	OFF	-	-
0	1	ON	fs = 32 kHz	BS, DAT
1	0	ON	fs = 44.1 kHz	CD
1	1	ON	fs = 48 kHz	BS, DAT

## TYPICAL APPLICATION

A typical application with eight-times oversampling, format A input and output data, and attenuation set by a CPU, is shown in figure 12.

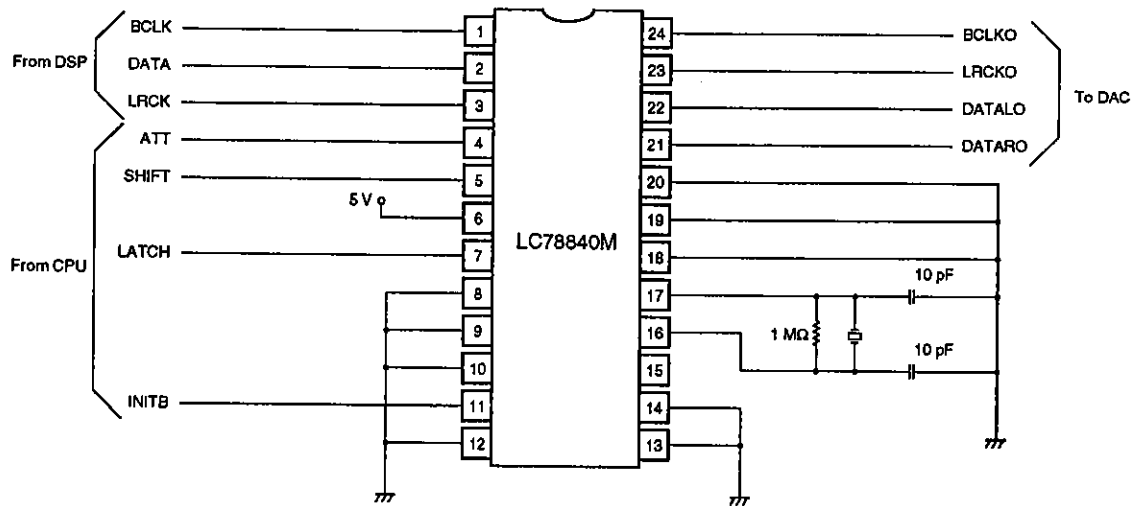

Figure 12. Digital filter

- No products described or contained herein are intended for use in surgical implants, life-support systems, aerospace equipment, nuclear power control systems, vehicles, disaster/crime-prevention equipment and the like, the failure of which may directly or indirectly cause injury, death or property loss.
- Anyone purchasing any products described or contained herein for an above-mentioned use shall:
  - ① Accept full responsibility and indemnify and defend SANYO ELECTRIC CO., LTD., its affiliates, subsidiaries and distributors and all their officers and employees, jointly and severally, against any and all claims and litigation and all damages, cost and expenses associated with such use:
  - ② Not impose any responsibility for any fault or negligence which may be cited in any such claim or litigation on SANYO ELECTRIC CO., LTD., its affiliates, subsidiaries and distributors or any of their officers and employees jointly or severally.
- Information (including circuit diagrams and circuit parameters) herein is for example only; it is not guaranteed for volume production. SANYO believes information herein is accurate and reliable, but no guarantees are made or implied regarding its use or any infringements of intellectual property rights or other rights of third parties.