



	LCA717	Units
Blocking Voltage	30	V _p
Load Current	2	A _{DC} /A _{rms}
Max R _{ON}	0.15	Ω

Features

- Small 6 Pin DIP Package
- Low Drive Power Requirements (TTL/CMOS Compatible)
- No Moving Parts
- High Reliability
- Arc-Free With No Snubbing Circuits
- 3750V_{rms} Input/Output Isolation
- No EMI/RFI Generation
- Machine Insertable, Wave Solderable
- Surface Mount, Tape & Reel Version Available

Applications

- Sensor Circuitry
- Instrumentation
- Multiplexers
- Data Acquisition
- Electronic Switching
- I/O Subsystems
- Meters (Watt-Hour, Water, Gas)
- Medical Equipment
Patient/Equipment Isolation
- Aerospace
- Industrial Controls

Description

The LCA717 is a 30V single-pole normally-open (1-Form-A) Solid State Relay. The ultra-low on-resistance of this relay enables high-current operation. Clare's patented OptoMOS architecture makes available the optically coupled technology necessary to activate the output's efficient MOSFET switches, while providing 3750V_{rms} input-to-output isolation. Control of the isolated output is accomplished by means of the highly effective GaAlAs infrared LED at the input.

Approvals

- UL Recognized Component: File # E76270
- CSA Certified Component: Certificate # 1175739
- EN/IEC 60950-1 Compliant

Ordering Information

Part #	Description
LCA717	6 Pin DIP (50/Tube)
LCA717S	6 Pin Surface Mount (50/Tube)
LCA717STR	6 Pin Surface Mount (1000/Reel)

Pin Configuration

AC/DC Configuration

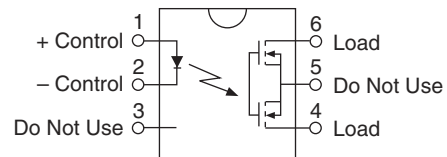

DC Only Configuration

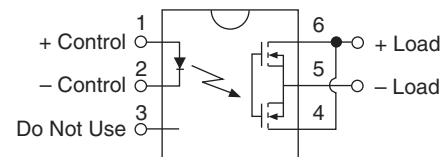

Switching Characteristics of Normally Open (Form A) Devices

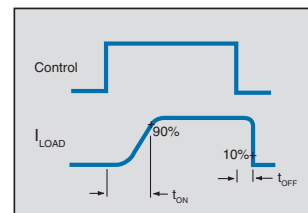

Absolute Maximum Ratings (@ 25°C)

Parameter	Ratings	Units
Blocking Voltage	30	V _P
Reverse Input Voltage	5	V
Input Control Current	50	mA
Peak (10ms)	1	A
Input Power Dissipation ¹	100	mW
Total Power Dissipation ²	800	mW
Isolation Voltage, Input to Output	3750	V _{rms}
Operational Temperature	-40 to +85	°C
Storage Temperature	-40 to +125	°C

¹ Derate Linearly 1.33 mW/°C

² Derate Linearly 6.67 mW/°C

Absolute Maximum Ratings are stress ratings. Stresses in excess of these ratings can cause permanent damage to the device. Functional operation of the device at conditions beyond those indicated in the operational sections of this data sheet is not implied.

Electrical Characteristics

Parameter	Conditions	Symbol	Min	Typ	Max	Units
Output Characteristics @ 25°C						
Load Current, Continuous						
AC/DC Configuration	-	I _L	-	-	2.0	A _{DC} /A _{rms}
DC Configuration					4.0	A
Peak Load Current	t=10ms	I _{LPK}	-	-	5.0	A
On-Resistance ¹						
AC/DC Configuration	I _L =1A	R _{ON}	-	0.083	0.15	Ω
DC Configuration				0.023	0.04	
Off-State Leakage Current	V _L =30V _P	I _{LEAK}	-	-	1	μA
Switching Speeds						
Turn-On	I _F =5mA, V _L =10V	t _{ON}	-	0.92	3	ms
Turn-Off		t _{OFF}		0.44	3	
Output Capacitance	15V; f=1MHz	C _{OUT}	-	100	-	pF
Input Characteristics @ 25°C						
Input Control Current	I _L =1A	I _F	-	0.115	2	mA
Input Dropout Current	-	I _F	0.1	-	-	mA
Input Voltage Drop	I _F =5mA	V _F	0.9	1.2	1.4	V
Reverse Input Current	V _R =5V	I _R	-	-	10	μA
Common Characteristics @ 25°C						
Input to Output Capacitance	-	C _{I/O}	-	3	-	pF

¹ Measurement taken within 1 second of on-time.

ESD Rating

ESD Rating (Human Body Model)
1000 Volts

PERFORMANCE DATA*

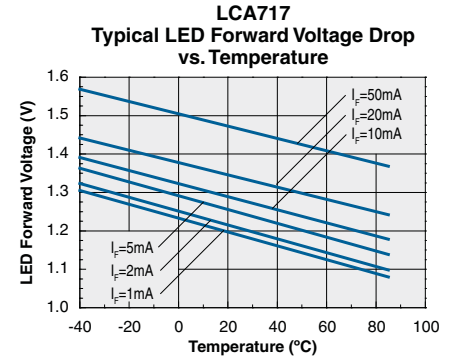
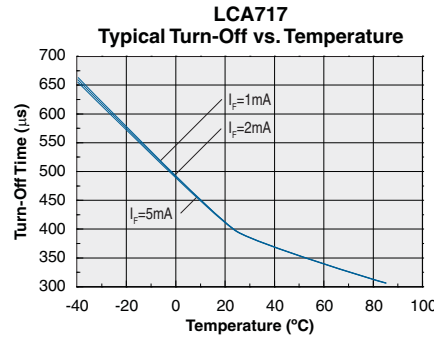
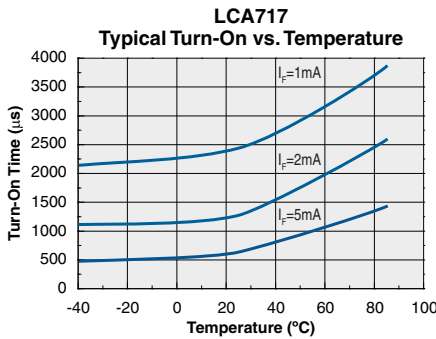
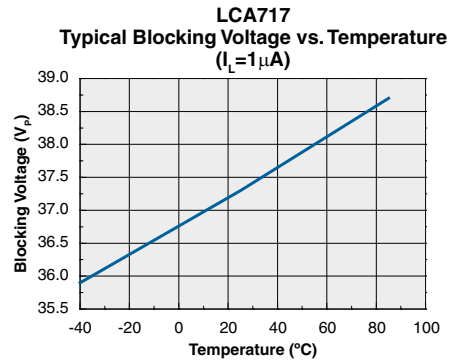
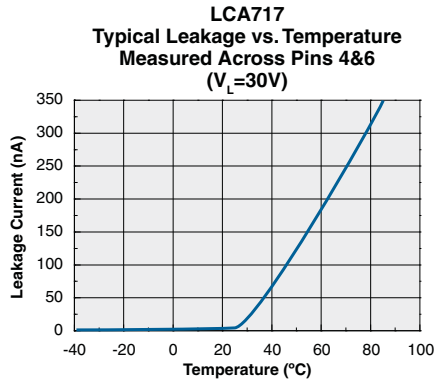
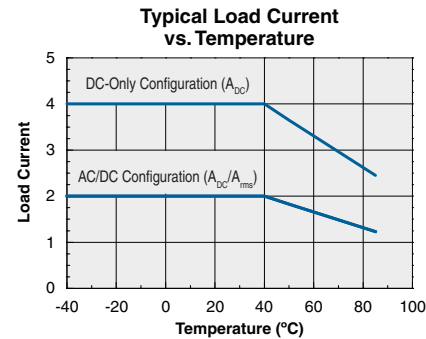
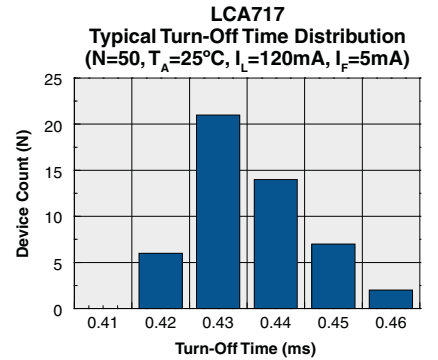
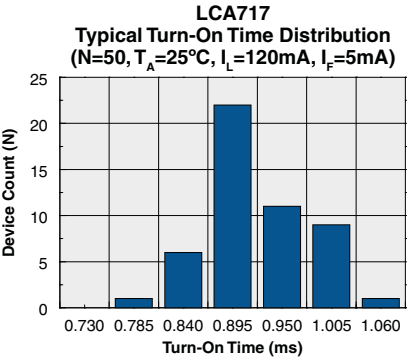
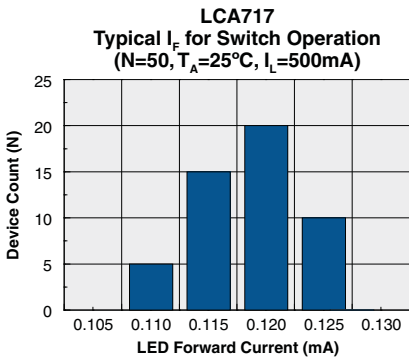
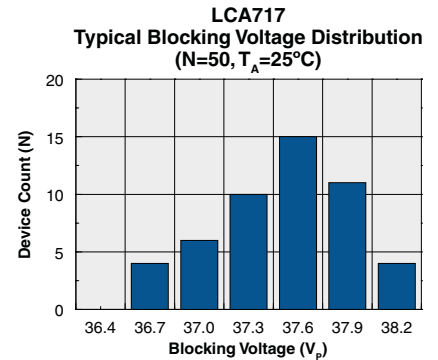
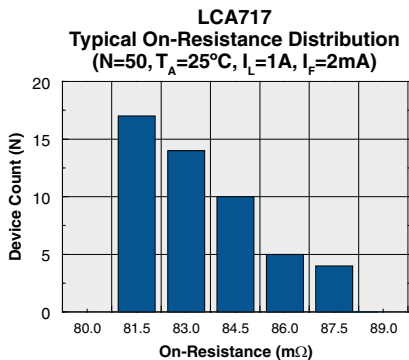
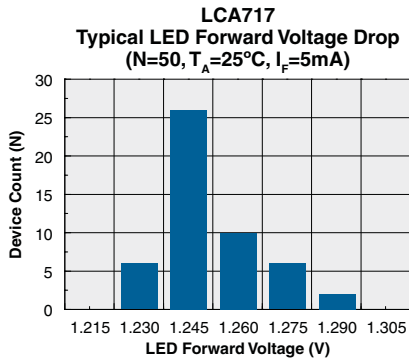

*The Performance data shown in the graphs above is typical of device performance. For guaranteed parameters not indicated in the written specifications, please contact our application department.

PERFORMANCE DATA*

LCA717
Typical Turn-On vs. LED Forward Current
($T_A=25^\circ\text{C}$)

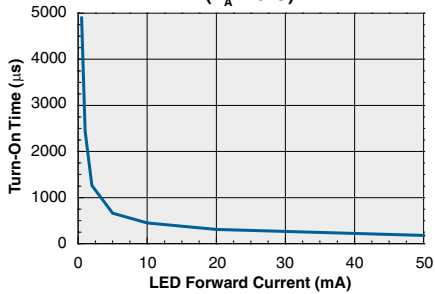

LCA717
Typical Turn-Off vs. LED Forward Current
($T_A=25^\circ\text{C}$)

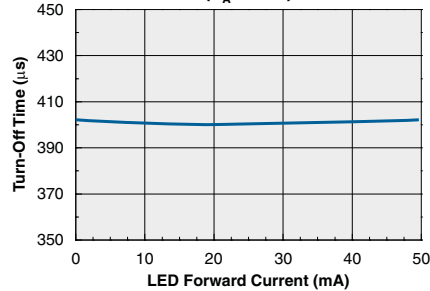

LCA717
Typical On-Resistance vs. Temperature
($I_L=1\text{A}, I_F=2\text{mA}$)

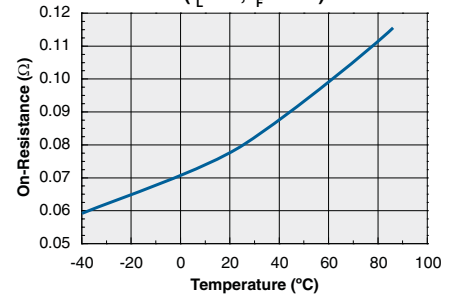

LCA717
Typical I_F for Switch Operation
vs. Temperature
($I_L=1\text{A}$)

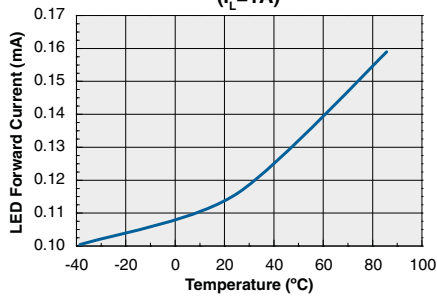

LCA717
Typical Load Current vs. Load Voltage
($T_A=25^\circ\text{C}, I_F=2\text{mA}$)

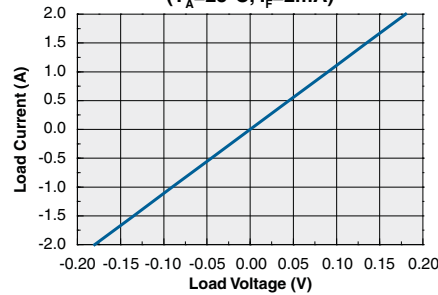

LCA717
Energy Rating Curve
($T_A=25^\circ\text{C}$)

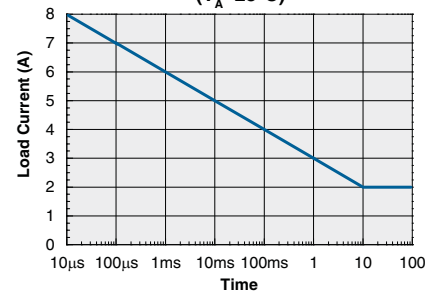

*The Performance data shown in the graphs above is typical of device performance. For guaranteed parameters not indicated in the written specifications, please contact our application department.

Manufacturing Information

Soldering

For proper assembly, the component must be processed in accordance with the current revision of IPC/JEDEC standard J-STD-020. Failure to follow the recommended guidelines may cause permanent damage to the device resulting in impaired performance and/or a reduced lifetime expectancy.

Washing

Clare does not recommend ultrasonic cleaning or the use of chlorinated solvents.



MECHANICAL DIMENSIONS

6-Pin DIP Thru-Hole Package

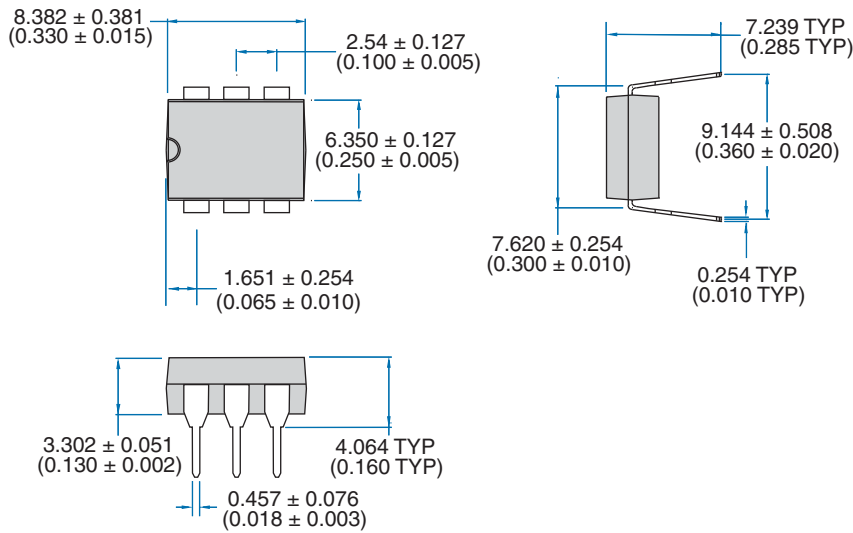

PC Board Pattern

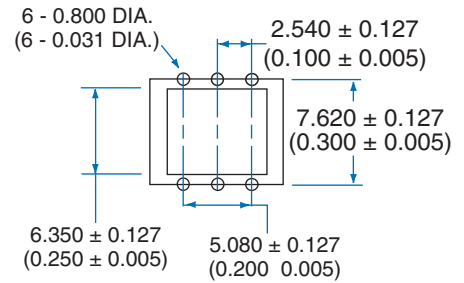

Dimensions
mm
(inches)

6-Pin Surface Mount Package ("S" Suffix)

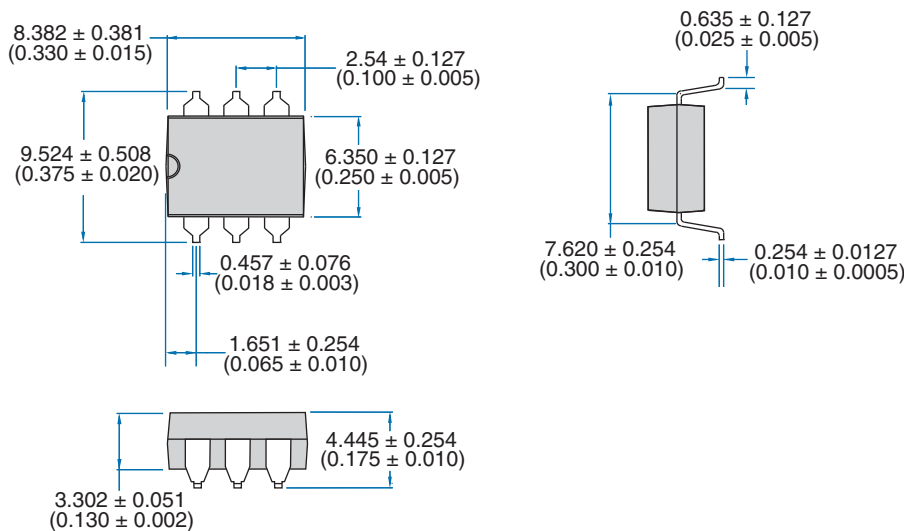

Recommended PCB Land Pattern

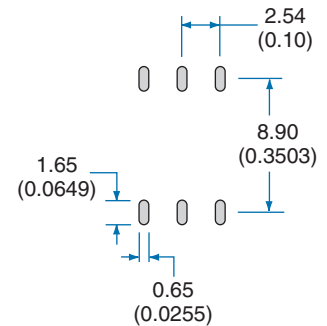

Dimensions
mm
(inches)

MECHANICAL DIMENSIONS (Cont.)

Tape and Reel Packaging for 6-Pin “S” Suffix Parts

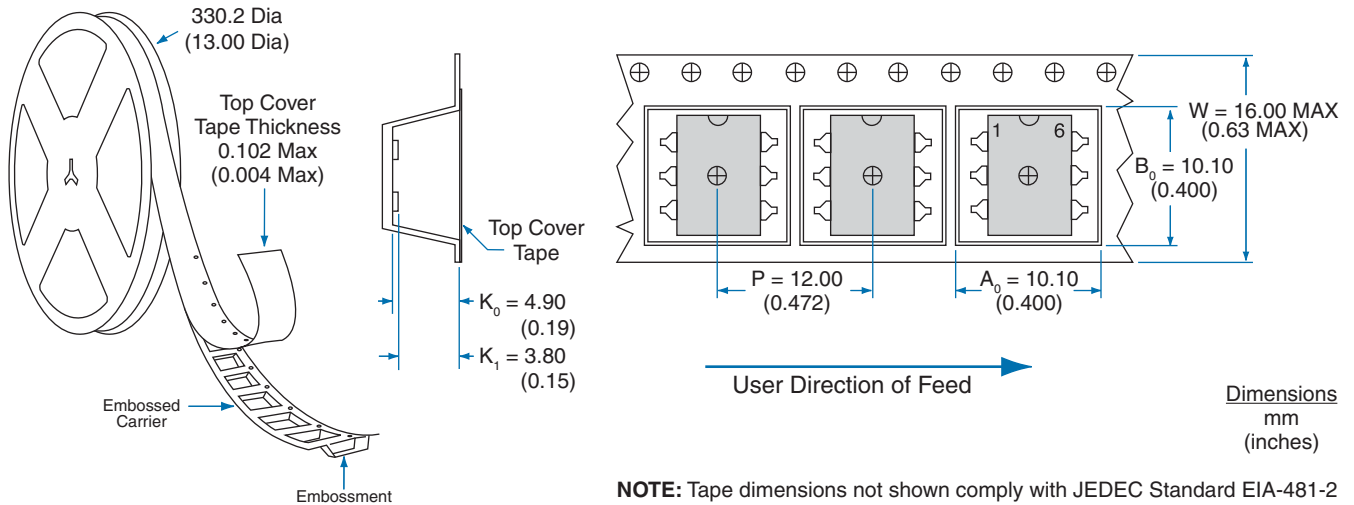

NOTE: Tape dimensions not shown comply with JEDEC Standard EIA-481-2

For additional information please visit our website at: www.clare.com

Clare, Inc. makes no representations or warranties with respect to the accuracy or completeness of the contents of this publication and reserves the right to make changes to specifications and product descriptions at any time without notice. Neither circuit patent licenses nor indemnity are expressed or implied. Except as set forth in Clare's Standard Terms and Conditions of Sale, Clare, Inc. assumes no liability whatsoever, and disclaims any express or implied warranty, relating to its products including, but not limited to, the implied warranty of merchantability, fitness for a particular purpose, or infringement of any intellectual property right.

The products described in this document are not designed, intended, authorized or warranted for use as components in systems intended for surgical implant into the body, or in other applications intended to support or sustain life, or where malfunction of Clare's product may result in direct physical harm, injury, or death to a person or severe property or environmental damage. Clare, Inc. reserves the right to discontinue or make changes to its products at any time without notice.