

Digital transistors (built-in resistors)

• **Features**

- 1) Built-in bias resistors enable the configuration of an inverter circuit without connecting external input resistors (see the equivalent circuit).
- 2) The bias resistors consist of thin-film resistors with complete isolation to allow negative biasing of the input. They also have the advantage of almost completely eliminating parasitic effects.
- 3) Only the on/off conditions need to be set for operation, making device design easy.

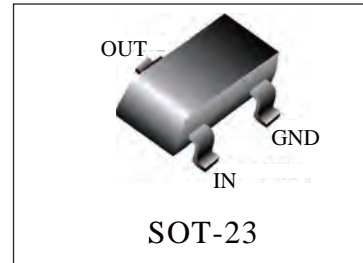

• **Device Marking and Ordering Information**

Device	Marking	R1 (K)	R2 (K)	Shipping
LDTD113ZLT1G	E8	1	10	3000/Tape & Reel

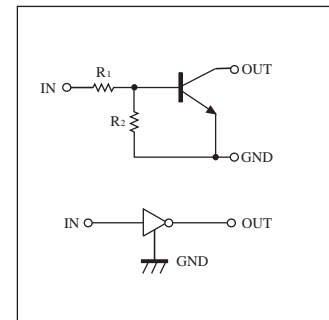

• **Absolute maximum ratings** ($T_A = 25^\circ\text{C}$)

Parameter	Symbol	Limits	Unit
Supply voltage	V_{CC}	50	V
Input voltage	V_{IN}	-5~+10	V
Output current	I_C	500	mA
Power dissipation	P_d	200	mW
Junction temperature	T_j	150	$^\circ\text{C}$
Storage temperature	T_{stg}	-55~+150	$^\circ\text{C}$

• **Electrical characteristics** ($T_A = 25^\circ\text{C}$)

Parameter	Symbol	Min.	Typ.	Max.	Unit	Conditions
Input voltage	$V_{(off)}$	—	—	0.3	V	$V_{CC}=5V, I_o=100\mu A$
	$V_{(on)}$	1.5	—	—		$V_o=0.3V, I_o=20mA$
Output voltage	$V_{O(on)}$	—	0.1	0.3	V	$I_o/I_i=50mA/2.5mA$
Input current	I_i	—	—	7.2	mA	$V_i=5V$
Output current	$I_{O(off)}$	—	—	0.5	μA	$V_{CC}=50V, V_i=0V$
DC current gain	G_i	82	—	—	—	$V_o=5V, I_o=50mA$
Input resistance	R_1	0.7	1	1.3	$k\Omega$	—
Resistance ratio	R_2/R_1	8	10	12	—	—
Transition frequency	f_r □	—	200	—	MHz	$V_{CE}=10V, I_E=-50mA, f=100MHz$

□ Characteristics of built-in transistor

• **Electrical characteristic curves**

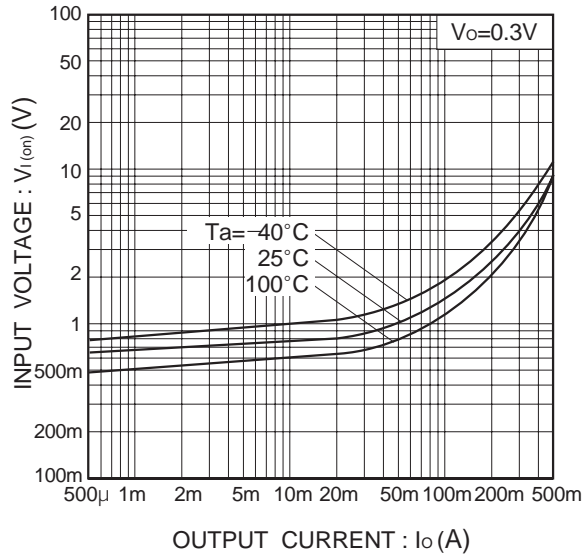

Fig.1 Input voltage vs. output current (ON characteristics)

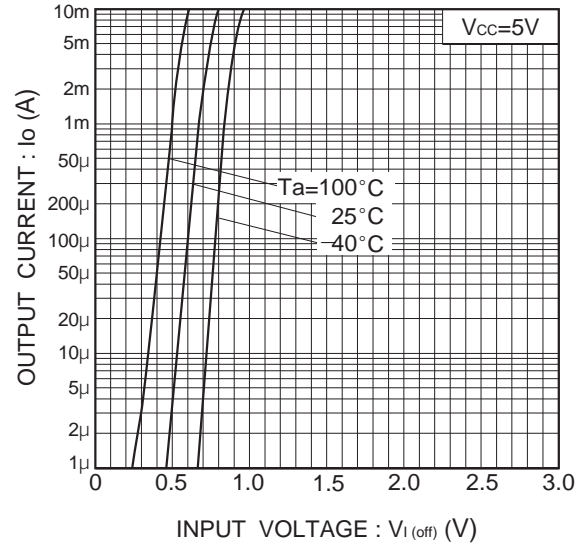

Fig.2 Output current vs. input voltage (OFF characteristics)

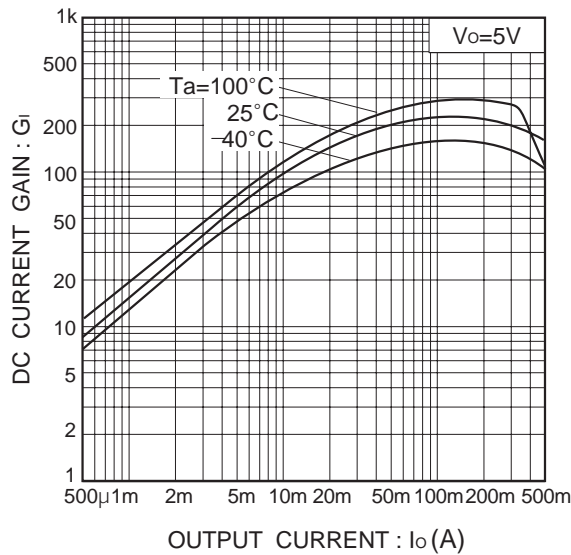

Fig. 3 DC current gain vs. output current

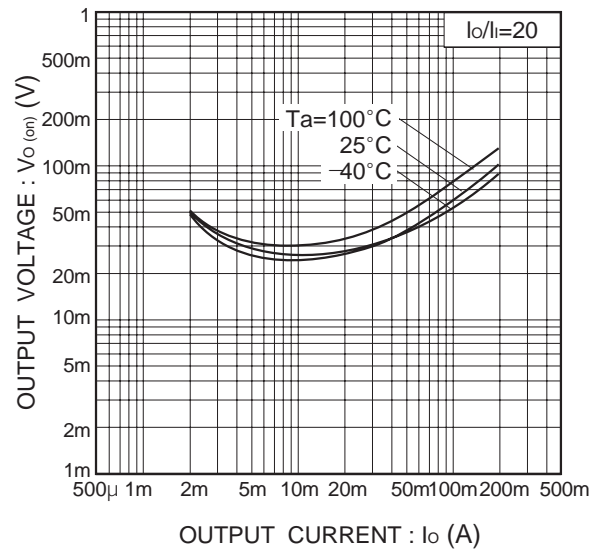
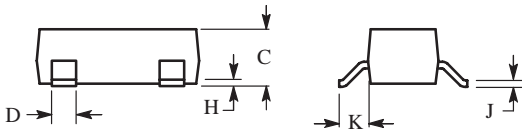
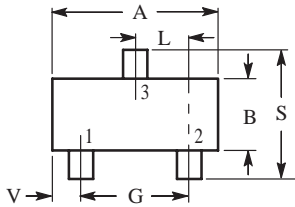

Fig.4 Output voltage vs. output current

SOT-23



NOTES:

1. DIMENSIONING AND TOLERANCING PER ANSI Y14.5M, 1982.
2. CONTROLLING DIMENSION: INCH.

DIM	INCHES		MILLIMETERS	
	MIN	MAX	MIN	MAX
A	0.1102	0.1197	2.80	3.04
B	0.0472	0.0551	1.20	1.40
C	0.0350	0.0440	0.89	1.11
D	0.0150	0.0200	0.37	0.50
G	0.0701	0.0807	1.78	2.04
H	0.0005	0.0040	0.013	0.100
J	0.0034	0.0070	0.085	0.177
K	0.0140	0.0285	0.35	0.69
L	0.0350	0.0401	0.89	1.02
S	0.0830	0.1039	2.10	2.64
V	0.0177	0.0236	0.45	0.60

- PIN 1 BASE
 2 EMITTER
 3 COLLECTOR

