

# LF100ED Series

## Lowest Cost, Dual Output Ultra-Miniature 1W SMT DC/DC Converters

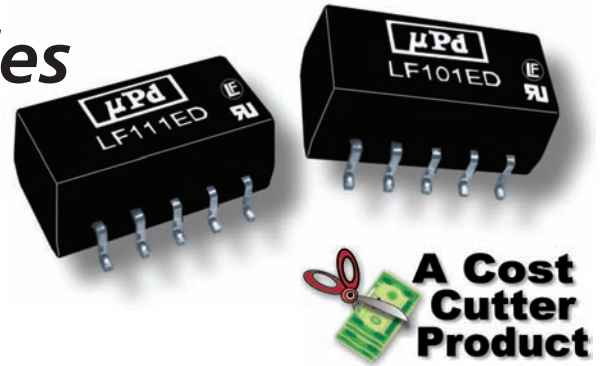

**A Cost Cutter Product**

### Key Features:

- 1W Output Power
- Ultra-Miniature SMT Case
- UL Approved (File E245422)
- Dual Outputs
- Low 0.29" Profile
- 1,000 VDC Isolation
- >3.5 MHour MTBF
- 3.3V, 5V, & 12V Inputs
- **LOWEST COST!**

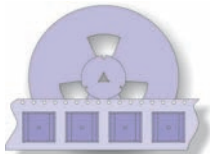

**Tape/Reel Available**

### MicroPower Direct

292 Page Street  
Suite D  
Stoughton, MA 02072  
USA

T: (781) 344-8226  
F: (781) 344-8481  
E: sales@micropowerelectronics.com  
W: www.micropowerelectronics.com



### Electrical Specifications

Specifications typical @ +25°C, nominal input voltage & rated output current, unless otherwise noted. Specifications subject to change without notice.

#### Input

Parameter	Conditions	Min.	Typ.	Max.	Units
Input Voltage Range	3.3 VDC Input	3.0	3.3	3.6	VDC
	5 VDC Input	4.5	5.0	5.5	
	12 VDC Input	10.8	12.0	13.2	
Reverse Polarity Input Current				1.0	A
Input Filter	Capacitor				

#### Output

Parameter	Conditions	Min.	Typ.	Max.	Units
Output Voltage Accuracy			±3.0		%
Output Voltage Balance	Balanced Loads		±1.0		%
Line Regulation	For Vin Change of 1%			±1.2	%
Load Regulation (Note 1)	See Model Selection Guide				
Ripple & Noise (20 MHz) (Note 2)			50	75	mV P - P
Temperature Coefficient				±0.03	%/°C
Output Short Circuit	Momentary (0.5 Sec.)				

#### General

Parameter	Conditions	Min.	Typ.	Max.	Units
Isolation Voltage	60 Seconds	1,000			VDC
Isolation Resistance	500 VDC	1,000			MΩ
Isolation Capacitance	100 kHz, 1V		70		pF
Switching Frequency			100		kHz

#### Environmental

Parameter	Conditions	Min.	Typ.	Max.	Units
Operating Temperature Range	Ambient	-40	+25	+85	°C
Storage Temperature Range		-55		+125	°C
Cooling	Free Air Convection				
Humidity	RH, Non-condensing			95	%

#### Physical

Case Size	0.60 x 0.29 x 0.24 Inches (15.24 x 7.5 x 6.0 mm)				
Case Material	Non-Conductive Black Plastic (UL94-V0)				
Weight	0.05 Oz (1.5g)				

#### Reliability Specifications

Parameter	Conditions	Min.	Typ.	Max.	Units
MTBF	MIL HDBK 217F, 25°C, Gnd Benign	3.5			MHours
Safety Standards	UL 1950, EN 60950, IEC 60950				
Safety Approvals	UL, cUL; File No. E245422				

#### Absolute Maximum Ratings

Parameter	Conditions	Min.	Typ.	Max.	Units
Input Voltage Surge (1 Sec)	3.3 VDC Input	-0.7		7.0	VDC
	5 VDC Input	-0.7		7.0	
	12 VDC Input	-0.7		15.0	
Lead Temperature	1.5 mm From Case For 10 Sec			260.0	°C
Internal Power Dissipation	All Models			450	mW

**Caution:** Exceeding Absolute Maximum Ratings may damage the module. These are not continuous operating ratings.

# Model Selection Guide

Model Number	Input				Output			Load Regulation (% Max)	Efficiency (% Typ)	Fuse Rating Slow-Blow (mA)
	Voltage (VDC)		Current (mA)		Voltage (VDC)	Current (mA, Max)	Current (mA, Min)			
	Nominal	Range	Full-Load	No-Load						
LF101ED	5	4.5 - 5.5	277	30	±5.0	±100.0	±10.0	12.0	72	500
LF102ED	5	4.5 - 5.5	250	30	±9.0	±56.0	±6.0	8.0	75	500
LF103ED	5	4.5 - 5.5	256	30	±12.0	±42.0	±5.0	8.5	78	500
LF104ED	5	4.5 - 5.5	253	30	±15.0	±33.0	±4.0	7.0	79	500
LF111ED	12	10.8 - 13.2	112	15	±5.0	±100.0	±10.0	12.0	74	200
LF112ED	12	10.8 - 13.2	110	15	±9.0	±56.0	±6.0	8.0	76	200
LF113ED	12	10.8 - 13.2	105	15	±12.0	±42.0	±5.0	8.5	78	200
LF114ED	12	10.8 - 13.2	104	15	±15.0	±33.0	±4.0	7.0	79	200
LF151ED	3.3	3.0 - 3.6	452	55	±5.0	±100.0	±10.0	12.0	67	750
LF152ED	3.3	3.0 - 3.6	445	55	±12.0	±42.0	±5.0	8.5	68	750
LF153ED	3.3	3.0 - 3.6	432	55	±15.0	±33.0	±4.0	7.0	70	750

**Notes:**

- Output load regulation is specified for a load change of 20% to 100%.
- When measuring output ripple, it is recommended that an external 0.33 μF ceramic capacitor be placed from the +Vout pin to the -Vout pin for single output units and from each output to common for dual output units.
- During operation, care must be taken not to exceed the specified input range of the unit or to allow the output load to drop below the specified minimum (10% of full load). Operating the unit under either of these conditions could cause damage to the unit.
- These converters are specified for operation without external components. However, in some applications the addition of input/output capacitors will enhance stability and reduce output ripple. Recommended capacitor values are:

Vin	Input Capacitor	Vout	Output Capacitor
5 VDC	4.7 μF	5 VDC	4.7 μF
12 VDC	2.2 μF	9 VDC	2.2 μF
24 VDC	1.0 μF	12 VDC	1.0 μF
		15 VDC	0.47 μF

For applications requiring very low output noise levels, a simple LC filter should be effective.  
 5. It is recommended that a fuse be used on the input of a power supply for protection. See the Model Selection table above for the correct rating.

## Mechanical Dimensions

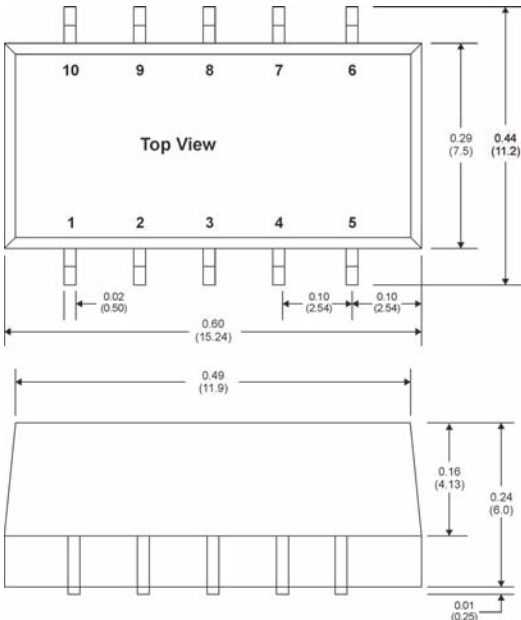

## Pin Connections

Pin	Description	Pin	Description
1	-Vin	6	NC
2	+Vin	7	+Vout
3	NC	8	NC
4	Common	9	NC
5	-Vout	10	NC

NC = No Connection

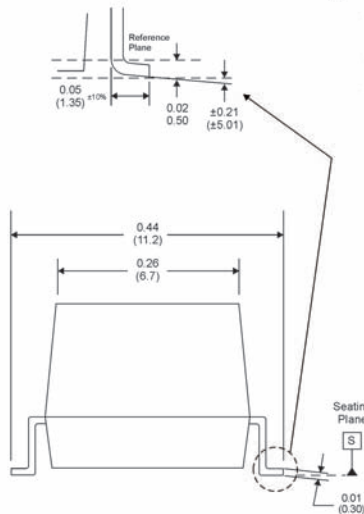

**Notes:**

- All dimensions are typical in inches (mm)
- Tolerance x.xx = ±0.01 (±0.25)
- Pin 1 is marked by a "dot" or indentation on the unit

## Derating Curve

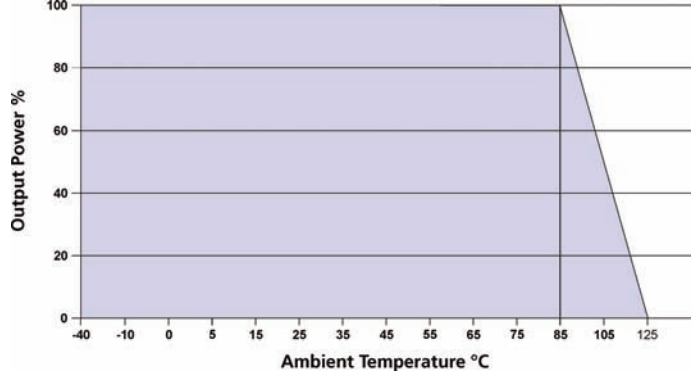

## Recommended Solder Profile

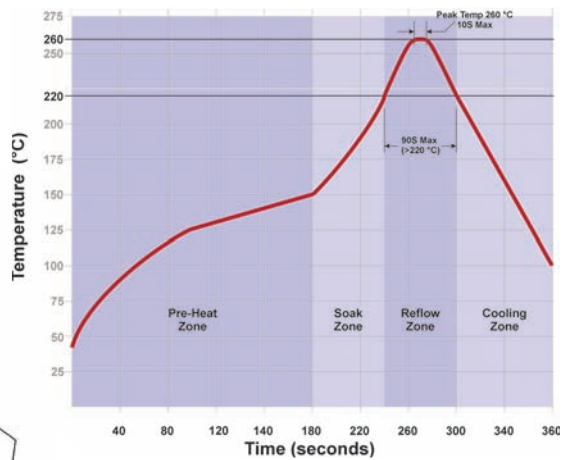

## Board Layout

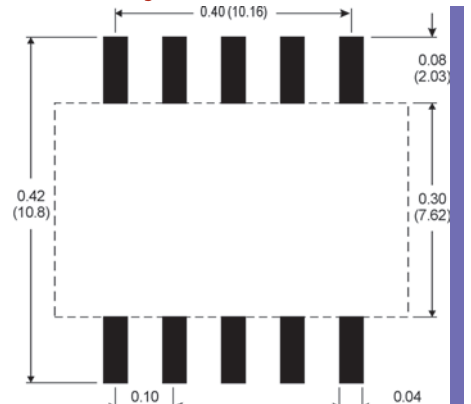

**MicroPower Direct**

[www.micropowerdirect.com](http://www.micropowerdirect.com)