

Temperature Sensors

Description

Power-One offers a wide range of battery charger systems for power requirements of 50 Watt up to 8000 Watt.

For this purpose Power-One supplies temperature sensors and adapted power supplies. The batteries (lead acid batteries) are charged according to the battery temperature and the ambient temperature. If the battery is fully charged it is maintained at the float charge voltage which represents the optimum point for maximum available energy in case of

need and optimum life expectancy of the battery. The type of sensor needed is defined mainly by three parameters: The nominal battery voltage (e.g. 24 V or 48 V), the temperature coefficient of the battery (e.g. -3.0 mV/K/cell) and the nominal floating charge voltage per cell of the battery at 20°C (e.g. 2.27 V/cell). The latter two are defined in the specifications of the battery given by the respective battery manufacturer.

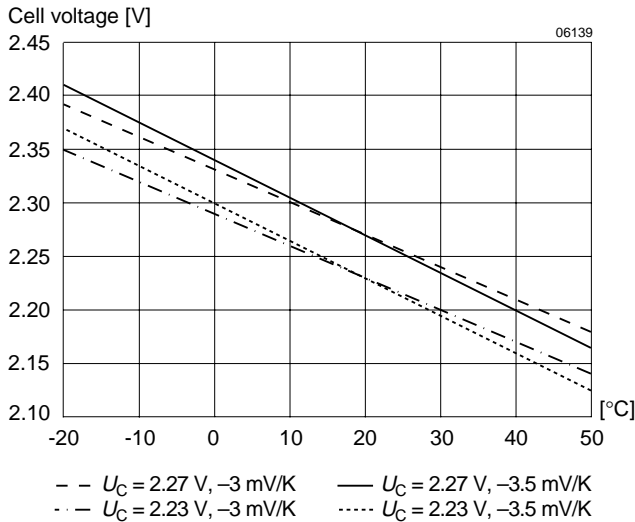

Fig. 1
Float charge voltage versus temperature for defined temperature coefficient.

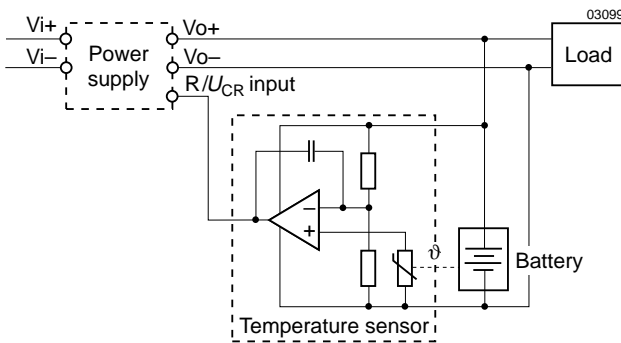

Fig. 2
Functional description



Table of Contents

	Page	Page
Description	1	Temperature Sensors for
Temperature Sensors for T and U units	1	M, H, S, K, KP, PSx, LW, OK Units
Mechanical Dimensions	2	Mechanical Dimensions
		Fail Safe Operation
		4

Temperature Sensors for T and U units

T and U units feature a cell voltage selector switch (feature Z) to set the required floating charge voltage at 20°C directly at the unit. If this Z switch is used the 2.23 V/cell sensor types should be selected in any case as a basis and the selection criteria are only the temperature coefficient of the battery and the nominal battery voltage. If for example a 24 V battery is used which has a cell voltage of 2.27 V/cell and a temperature coefficient of -3.5 mV/K/cell, the sensor type is S24-2.23-35-02. The setting on the Z switch of the T or U unit should be 2.27.

For units without the Z selector switch a sensor according to both criteria should be selected. In our example it would be S24-2.27-35-02.

For further details please consult the T or U datasheet.



Table 1: Type survey T sensors

Nominal battery voltage [V]	Sensor type	Part no.	Cell voltage [mV]	Temp. coefficient [mV/K/cell]	Cable length [m]
24	S24-2.23-30-02	MQC02052	2.23	-3.0	2
24	S24-2.23-35-02	MQC02053	2.23	-3.5	2
24	S24-2.23-45-02	MQC02051	2.23	-4.5	2
36	S36-2.23-30-02	MQC02081	2.23	-3.0	2
36	S36-2.23-35-02	MQC02082	2.23	-3.5	2
36	S36-2.27-35-02	MQC02083	2.27	-3.5	2
48	S48-2.23-30-02	MQC02008	2.23	-3.0	2
48	S48-2.23-35-02	MQC02009	2.23	-3.5	2
48	S48-2.23-40-02	MQC02013	2.23	-4.0	2
48	S48-2.23-45-02	MQC02012	2.23	-4.5	2
48	S48-2.27-30-02	MQC02010	2.27	-3.0	2
48	S48-2.27-35-02	MQC02007	2.27	-3.5	2
48	S48-2.27-45-02	MQC02006	2.27	-4.5	2

Other types for different cell voltages or temperature coefficients are available upon request.

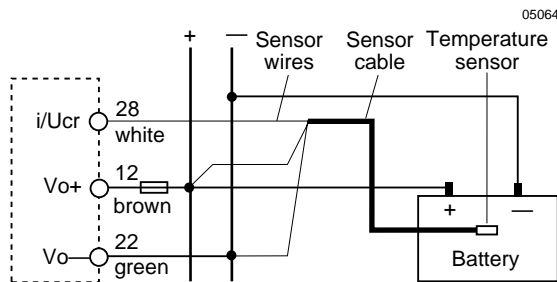

Fig. 3: Connection to the T unit.

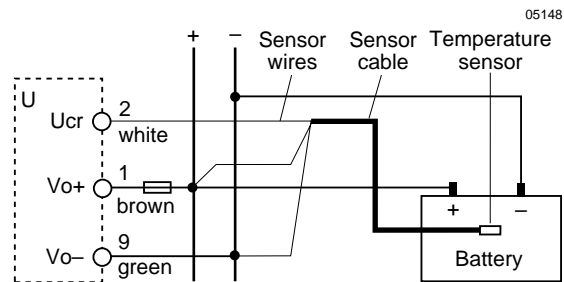

Fig. 4: Connection to the U unit.

Mechanical Dimensions

All dimensions in mm, tolerances ±0.3 mm unless otherwise specified.

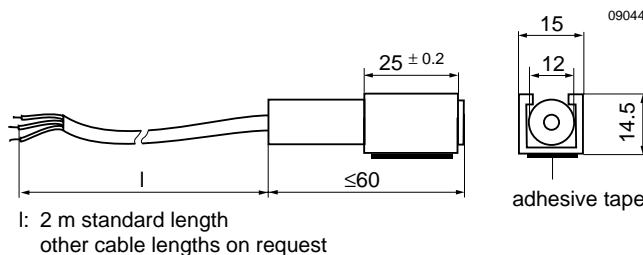

Fig. 5 T and U temperature sensor with mounting fixture.

Temperature Sensors for M, H, S, K, KP, PSx, W, OK Units

With M, H, S, K, KP, PSx, W and OK units the sensor signal acts on the R pin to adjust the output voltage relative to the battery temperature and the ambient temperature. As these units in contrast to the T and U units do not feature a cell voltage selector switch (Z switch) the sensor selection criteria is in every case both the cell voltage and the temperature coefficient (beside the nominal battery voltage).

If the application uses for example a 48 V battery with a cell voltage of 2.23 V/cell and a temperature coefficient of -3.0mV/K/cell the sensor S-KSMH48-2.23-30-2 should be selected.



Table 2: Type survey S-KSMH sensors

Nominal battery voltage [V]	Sensor type	Part no.	Cell voltage [mV]	Temp. coefficient [mV/K/cell]	Cable length [m]
12	S-KSMH12-2.27-30-2	MQC03005	2.27	-3.0	2
24	S-KSMH24-2.27-35-2	MQC03002	2.27	-3.5	2
24	S-KSMH24-2.27-30-2	MQC03004	2.27	-3.0	2
48	S-KSMH48-2.27-35-2	MQC03001	2.27	-3.5	2
48	S-KSMH48-2-27-30-2	MQC03003	2.27	-3.0	2

Other types for different cell voltages or temperature coefficients are available upon request.

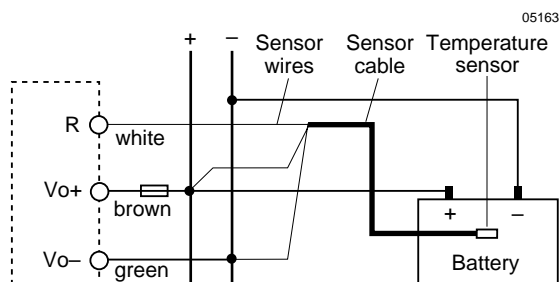

Fig. 6
Connection to a M, H, S, K, KP, LW or OK unit.

Mechanical Dimensions

All dimensions in mm, tolerances ± 0.3 mm unless otherwise specified.

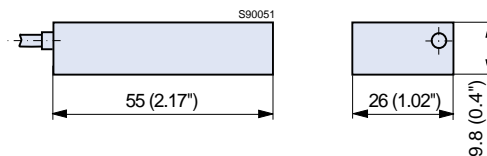

Fig. 7
S-KSMH temperature sensor.

Fail Safe Operation

To prevent overcharging of the battery but still maintain a minimum charging in case of interruption of the sensor signal cable to the power supply, Power-One has designed units with a special nominal output voltage setting. These units differ from the respective standard units described in the datasheet in the nominal output voltage and output current settings. Without the sensor connected to the R pin the output voltage will be higher than the nominal battery voltage to avoid a discharging of the battery but still lower than the theoretically needed float charge voltage. As soon as the sensor is connected to the R pin the output voltage will be set to the correct value.

Table 3:

Nominal battery voltage [V]	Output voltage setting (20°C) [V]
12	12.84
24	25.68
36	38.52
48	51.36
60	64.2

Table 4: Special units for battery charging

U_{batt} [V]	P_o 50 Watt	P_o 70 Watt	P_o 100 Watt	P_o 150 Watt	P_o 250 Watt
12	LM 1781-7R	LH 1781-2R	LS 4740-7R	LK 4740-7R	
24	LM 1782-7R	LH 1782-2R	LS 5740-7R	LK 5740-7R	LKP 5740-6R
36	LM 1783-7R	LH 1783-2R			
48	LM 1784-7R	LH 1784-2R	LS 5740-7R	LK 5740-7R	LKP 5740-6R
60	LM 1785-7R	LH 1785-2R			

Higher power requirements can be covered by paralleling of these units. Complete microprocessor controlled systems of un-interruptable power supplies (UPS) are realized by our Applications Center. Please consult your local Power-One representant.