

Cylinder Type Lithium Ion Capacitors

LIC1840R3R8107

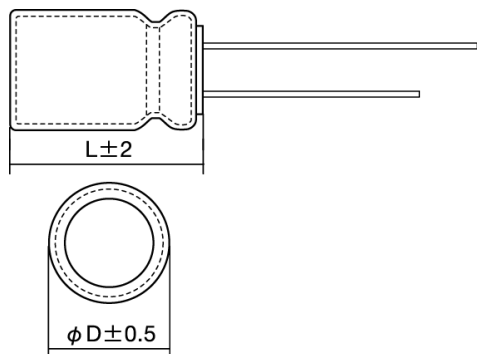

■ Features

- Item Summary
3.8(3.5)V, 2.2V, 100F±20%, Less than 0.1 Ω
- Lifecycle Stage
Mass Production

■ Products characteristics table

Temperature Range	-25 to +70(+85)℃
Maximum Usable Voltage	3.8(3.5)V
Min. Voltage	2.2V
Nominal Capacity	100F
Internal Resistance	0.1 Ω
Initial Capacitance	100F±20%
Initial Internal Resistance	Less than 0.1 Ω
RoHS Compliance	Yes
Soldering Method	Manual

2015.06.01

The data is reference only. Electrical characteristics vary depending on environment or measurement condition.
 TAIYO YUDEN reserves the right to make change to the Date at any time without notice.
 Before making final selection, please check product specification.