

# General Purpose Transistor

## PNP Silicon

- Pb-Free Package May be Available. The G-Suffix Denotes a Pb-Free Lead Finish

**LMBT2907LT1**  
**LMBT2907ALT1**

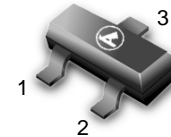

**SOT-23**

### MAXIMUM RATINGS

Rating	Symbol	Value		Unit
		2907	2907A	
Collector-Emitter Voltage	$V_{CEO}$	-40	-60	Vdc
Collector-Base Voltage	$V_{CBO}$		-60	Vdc
Emitter-Base Voltage	$V_{EBO}$		-5.0	Vdc
Collector Current — Continuous	$I_C$		-600	mAdc

### THERMAL CHARACTERISTICS

Characteristic	Symbol	Max	Unit
Total Device Dissipation FR-5 Board, (1) $T_A = 25^\circ\text{C}$	$P_D$	225	mW
Derate above $25^\circ\text{C}$		1.8	mW/ $^\circ\text{C}$
Thermal Resistance, Junction to Ambient	$R_{\theta JA}$	556	$^\circ\text{C}/\text{W}$
Total Device Dissipation Alumina Substrate, (2) $T_A = 25^\circ\text{C}$	$P_D$	300	mW
Derate above $25^\circ\text{C}$		2.4	mW/ $^\circ\text{C}$
Thermal Resistance, Junction to Ambient	$R_{\theta JA}$	417	$^\circ\text{C}/\text{W}$
Junction and Storage Temperature	$T_J, T_{stg}$	-55 to +150	$^\circ\text{C}$

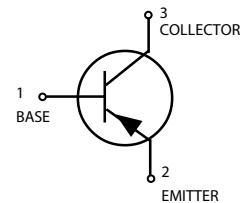

### ORDERING INFORMATION

Device	Package	Shipping
LMBT2907LT1	SOT-23	3000/Tape & Reel
LMBT2907LT1G	SOT-23	3000/Tape & Reel
LMBT2907ALT1	SOT-23	3000/Tape & Reel
LMBT2907ALT1G	SOT-23	3000/Tape & Reel

### DEVICE MARKING

LMBT2907LT1 = M2B, LMBT2907ALT1 = 2F

### ELECTRICAL CHARACTERISTICS ( $T_A = 25^\circ\text{C}$ unless otherwise noted.)

Characteristic	Symbol	Min	Max	Unit
----------------	--------	-----	-----	------

### OFF CHARACTERISTICS

Collector-Emitter Breakdown Voltage(3) ( $I_C = -10\text{ mAdc}, I_E = 0$ )	$V_{(BR)CEO}$			Vdc
	LMBT2907	-40	—	
	LMBT2907A	-60	—	
Collector-Emitter Breakdown Voltage( $I_C = -10\ \mu\text{Adc}, I_E = 0$ )	$V_{(BR)CBO}$	-60	—	Vdc
Emitter-Base Breakdown Voltage( $I_E = -10\ \mu\text{Adc}, I_C = 0$ )	$V_{(BR)EBO}$	-5.0	—	Vdc
Collector Cutoff Current( $V_{CB} = -30\text{Vdc}, I_{BE(OFF)} = -0.5\text{Vdc}$ )	$I_{CEX}$	—	-50	nAdc
Collector Cutoff Current ( $V_{CB} = -50\text{Vdc}, I_E = 0$ )	$I_{CBO}$			$\mu\text{Adc}$
	LMBT2907	—	-0.020	
	LMBT2907A	—	-0.010	
( $V_{CB} = -50\text{Vdc}, I_E = 0, T_A = 125^\circ\text{C}$ )	LMBT2907	—	-20	
	LMBT2907A	—	-10	
Base Current( $V_{CE} = -30\text{Vdc}, V_{EB(OFF)} = -0.5\text{Vdc}$ )	$I_B$	—	-50	nAdc

- FR-5 = 1.0 x 0.75 x 0.062 in.
- Alumina = 0.4 x 0.3 x 0.024 in. 99.5% alumina.
- Pulse Test: Pulse Width  $\leq 300\ \mu\text{s}$ , Duty Cycle  $\leq 2.0\%$ .

**LMBT2907LT1 LMBT2907ALT1**

**ELECTRICAL CHARACTERISTICS** ( $T_A = 25^\circ\text{C}$  unless otherwise noted) (Continued)

Characteristic	Symbol	Min	Max	Unit
<b>ON CHARACTERISTICS</b>				
DC Current Gain ( $I_C = -0.1\text{mA}$ , $V_{CE} = -10\text{Vdc}$ )	$h_{FE}$	35	—	—
	LMBT2907	75	—	—
	LMBT2907A	—	—	—
( $I_C = -1.0\text{mA}$ , $V_{CE} = -10\text{Vdc}$ )	LMBT2907	50	—	—
	LMBT2907A	100	—	—
( $I_C = -10\text{mA}$ , $V_{CE} = -10\text{Vdc}$ )	LMBT2907	75	—	—
	LMBT2907A	100	—	—
( $I_C = -150\text{mA}$ , $V_{CE} = -10\text{Vdc}$ )(3)	LMBT2907	—	—	—
	LMBT2907A	100	300	—
( $I_C = -500\text{mA}$ , $V_{CE} = -10\text{Vdc}$ )(3)	LMBT2907	30	—	—
	LMBT2907A	50	—	—
Collector–Emitter Saturation Voltage(3) ( $I_C = -150\text{mA}$ , $I_B = -15\text{mA}$ ) ( $I_C = -500\text{mA}$ , $I_B = -50\text{mA}$ )	$V_{CE(sat)}$	—	-0.4 -1.6	Vdc
Base–Emitter Saturation Voltage(3) ( $I_C = -150\text{mA}$ , $I_B = -15\text{mA}$ ) ( $I_C = -500\text{mA}$ , $I_B = -50\text{mA}$ )	$V_{BE(sat)}$	—	-1.3 -2.6	Vdc

**SMALL-SIGNAL CHARACTERISTICS**

Current–Gain — Bandwidth Product(3),(4) ( $I_C = -50\text{mA}$ , $V_{CE} = -20\text{Vdc}$ , $f = 100\text{MHz}$ )	$f_T$	200	—	MHz
Output Capacitance ( $V_{CB} = -10\text{Vdc}$ , $I_E = 0$ , $f = 1.0\text{MHz}$ )	$C_{obo}$	—	8.0	pF
Input Capacitance ( $V_{EB} = -2.0\text{Vdc}$ , $I_C = 0$ , $f = 1.0\text{MHz}$ )	$C_{ibo}$	—	30	pF

**SWITCHING CHARACTERISTICS**

Turn–On Time Delay Time Rise Time	( $V_{CC} = -30\text{Vdc}$ , $I_C = -150\text{mA}$ , $I_{B1} = -15\text{mA}$ )	$t_{on}$ $t^d$ $t_r$	— — —	45 10 40	ns
Fall Time Storage Time Turn–Off Time	( $V_{CC} = -6.0\text{Vdc}$ , $I_C = -150\text{mA}$ , $I_{B1} = I_{B2} = 15\text{mA}$ )	$t_f$ $t_s$ $t_{off}$	— — —	30 80 100	ns

3. Pulse Test: Pulse Width  $\leq 300\ \mu\text{s}$ , Duty Cycle  $\leq 2.0\%$ .

4.  $f_T$  is defined as the frequency at which  $|h_{fe}|$  extrapolates to unity.

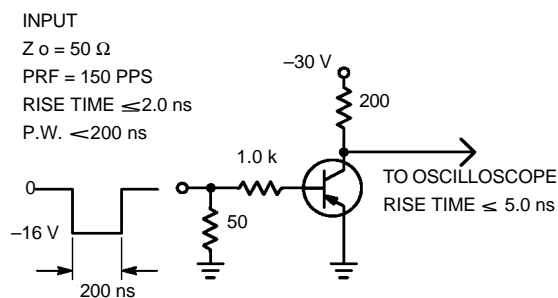

Figure 1. Delay and Rise Time Test Circuit

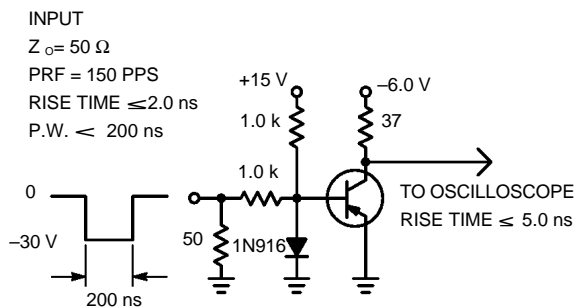

Figure 2. Storage and Fall Time Test Circuit

LMBT2907LT1 LMBT2907ALT1

TYPICAL CHARACTERISTICS

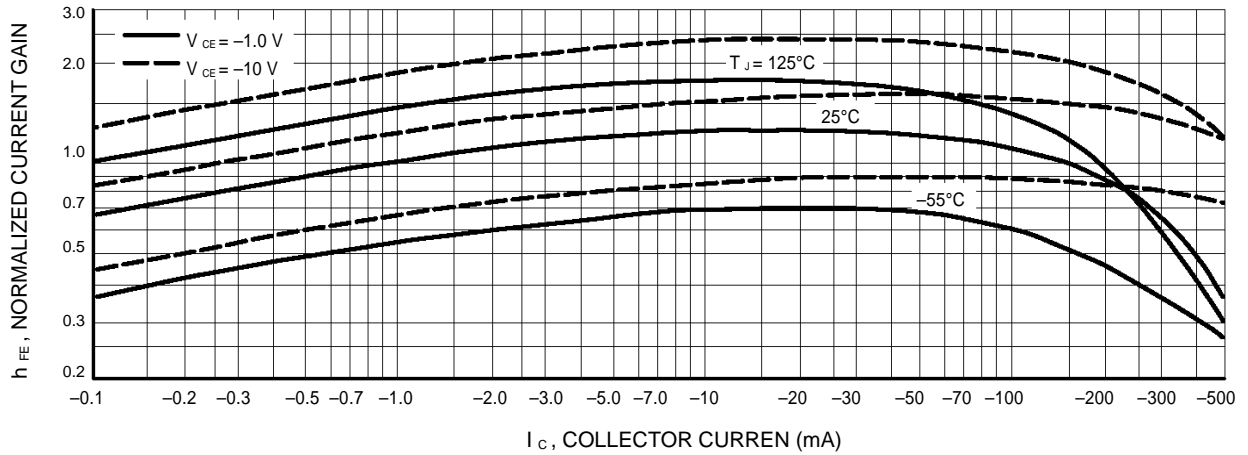

Figure 3. DC Current Gain

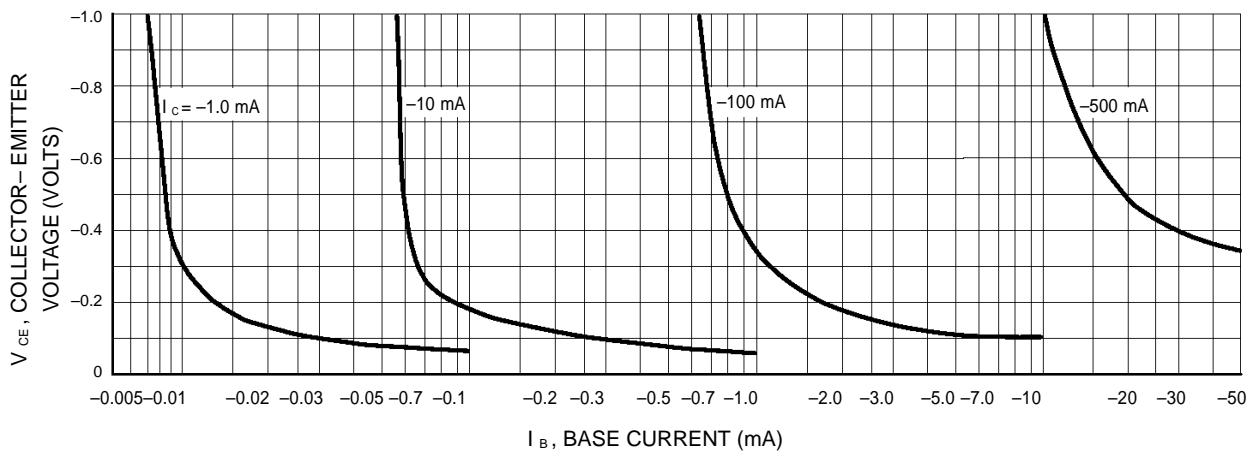

Figure 4. Collector Saturation Region

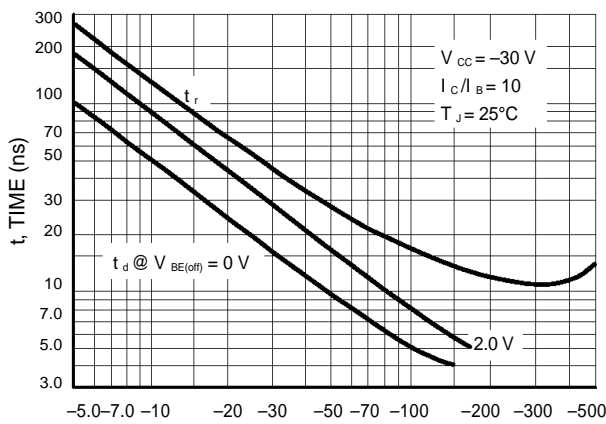

Figure 5. Turn-On Time

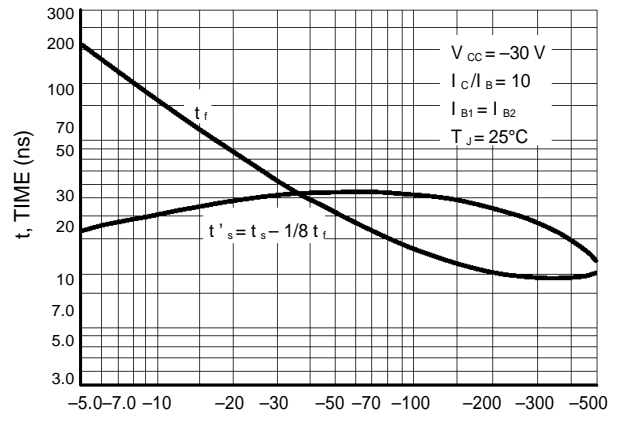

Figure 6. Turn-Off Time

**LMBT2907LT1 LMBT2907ALT1**

**TYPICAL SMALL-SIGNAL CHARACTERISTICS**

**NOISE FIGURE**

$V_{CE} = 10 \text{ Vdc}$ ,  $T_A = 25^\circ\text{C}$

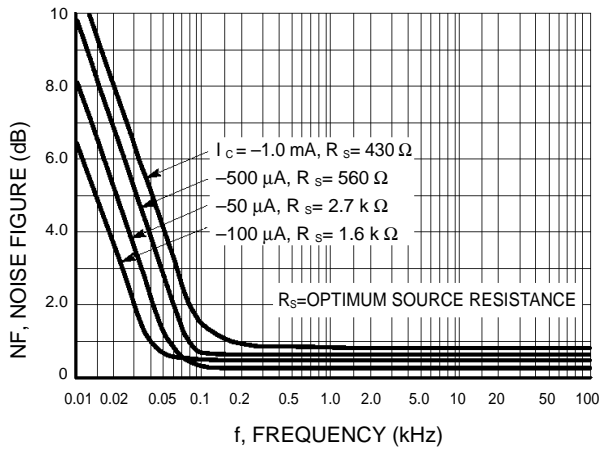

**Figure 7. Frequency Effects**

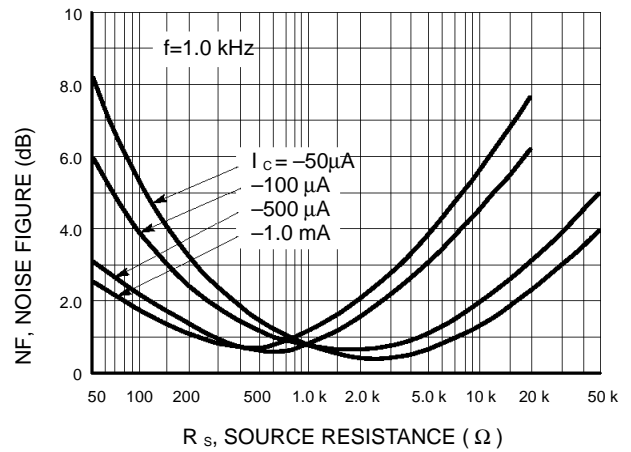

**Figure 8. Source Resistance Effects**

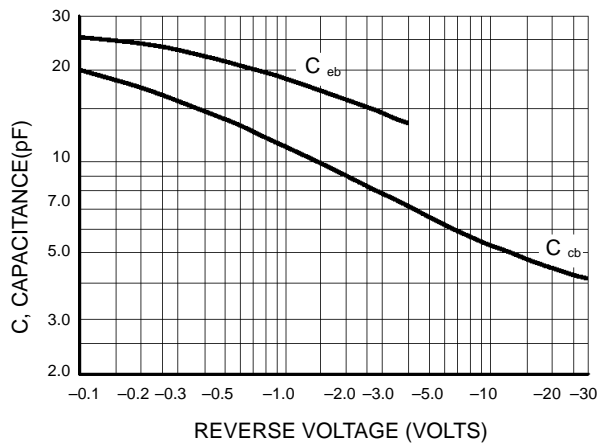

**Figure 9. Capacitances**

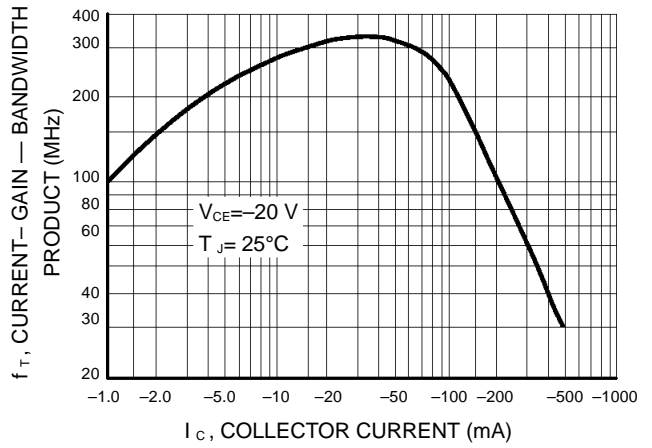

**Figure 10. Current-Gain — Bandwidth Product**

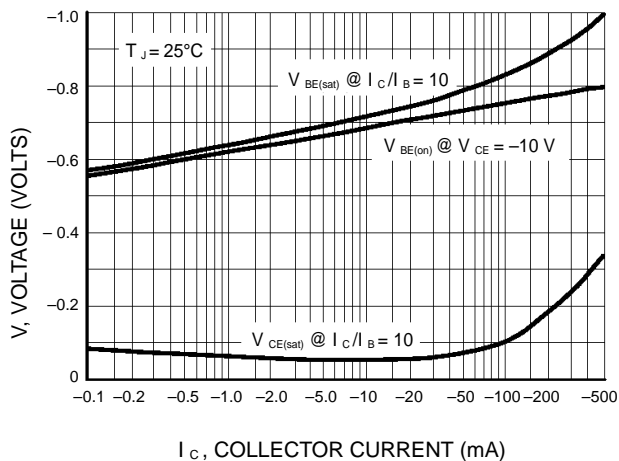

**Figure 11. "On" Voltage**

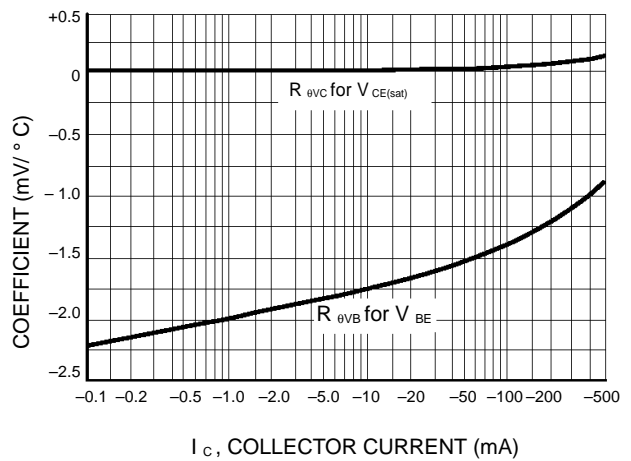

**Figure 12. Temperature Coefficients**

LMBT2907LT1 LMBT2907ALT1

SOT-23

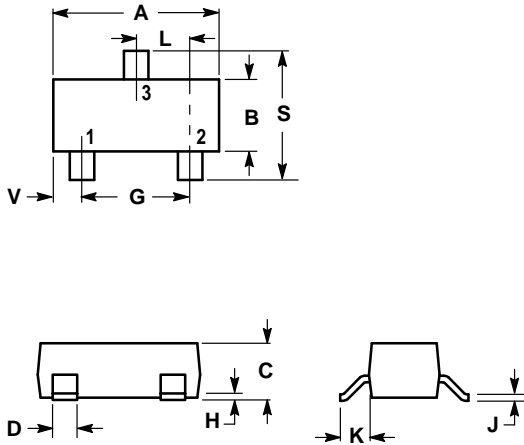

NOTES:

1. DIMENSIONING AND TOLERANCING PER ANSI Y14.5M, 1982.
2. CONTROLLING DIMENSION: INCH.

DIM	INCHES		MILLIMETERS	
	MIN	MAX	MIN	MAX
A	0.1102	0.1197	2.80	3.04
B	0.0472	0.0551	1.20	1.40
C	0.0350	0.0440	0.89	1.11
D	0.0150	0.0200	0.37	0.50
G	0.0701	0.0807	1.78	2.04
H	0.0005	0.0040	0.013	0.100
J	0.0034	0.0070	0.085	0.177
K	0.0140	0.0285	0.35	0.69
L	0.0350	0.0401	0.89	1.02
S	0.0830	0.1039	2.10	2.64
V	0.0177	0.0236	0.45	0.60

- PIN 1. BASE  
 2. EMITTER  
 3. COLLECTOR

