



LMV358

LINEAR INTEGRATED CIRCUIT

GENERAL PURPOSE, LOW VOLTAGE, RAIL-TO-RAIL OUTPUT OPERATIONAL AMPLIFIERS

DESCRIPTION

The UTC **LMV358** are low voltage (2.7-5.5V) versions of the dual and quad commodity op amps, LM358, which currently operate at 5-30V. The UTC **LMV358** are the most cost effective solutions for the applications where low voltage operation, space saving and low price are needed. They offer specifications that meet or exceed the familiar LM358. The UTC **LMV358** have rail-to-rail output swing capability and the input common-mode voltage range includes ground. They all exhibit excellent speed-power ratio, achieving 1MHz of bandwidth and 1V/ μ s of slew rate with low supply current.

The chips are built with National's advanced submicron silicon-gate BiCMOS process. The UTC **LMV358** have bipolar input and output stages for improved noise performance and higher output current drive.

FEATURES

(For $V^1 = 5V$ and $V = 0V$. Typical Unless Otherwise Noted)

*Guaranteed 2.7V and 5V Performance

*No Crossover Distortion

*Space Saving Package

*Industrial Temp. Range

*Gain-Bandwidth Product

*Low Supply Current: 210 μ A

*Rail-to-Rail Output Swing

@10k Ω Load $V^1 - 10mV$
 $V + 65mV$

* V_{CM} -0.2V to $V^1 - 0.8V$

ORDERING INFORMATION

Order Number		Package	Packing
Normal	Lead Free Plating		
LMV358-D08-T	LMV358L-D08-T	DIP-8	Tube
LMV358-P08-R	LMV358L-P08-R	TSSOP-8	Tape Reel
LMV358-P08-T	LMV358L-P08-T	TSSOP-8	Tube
LMV358-S08-R	LMV358L-S08-R	SOP-8	Tape Reel
LMV358-S08-T	LMV358L-S08-T	SOP-8	Tube

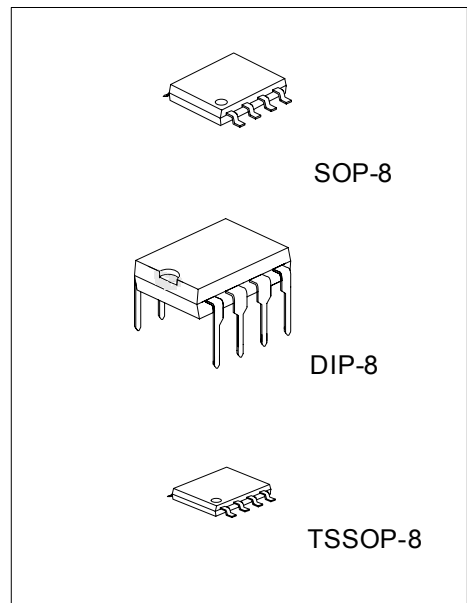

*Pb-free plating product number: LMV358L

<p>LMV358L-D08-T</p> <p>(1)Packing Type (2)Package Type (3)Lead Plating</p>	<p>(1) R: Tape Reel, T: Tube (2) D08: DIP-8, S08: SOP-8, P08: TSSOP-8 (3) L: Lead Free Plating, Blank: Pb/Sn</p>
---	--

■ PIN CONFIGURATIONS

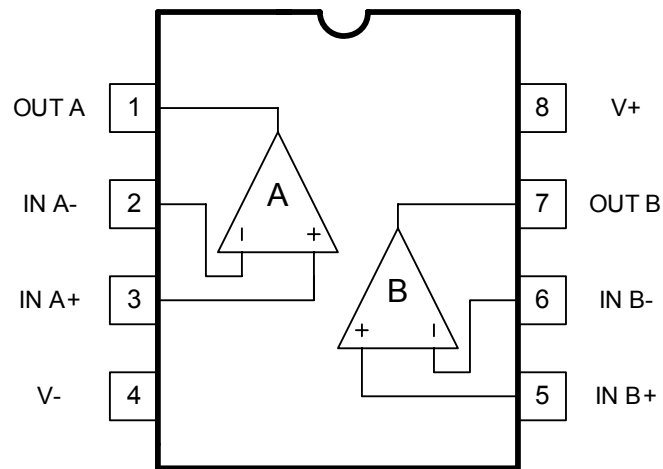

■ ABSOLUTE MAXIMUM RATINGS

PARAMETER	SYMBOL	RATINGS	UNIT
ESD Tolerance(Note 2)			
Machine Model		100	V
Human Body Model		2000	V
Differential Input Voltage	$V_{I(DIFF)}$	\pm Supply Voltage	
Supply Voltage (V^1 -V)	V_{SS}	5.5	V
Output Short Circuit to V^1		(Note 3)	
Output Short Circuit to V		(Note 4)	
Infrared (15 sec)		215	°C
Junction Temp. (T_J , max) (Note 5)	T_J	+150	°C
Storage Temp. Range	T_{STG}	-65 to 150	°C

Note Absolute maximum ratings are those values beyond which the device could be permanently damaged.

Absolute maximum ratings are stress ratings only and functional device operation is not implied.

■ OPERATING RATINGS (NOTE 1)

PARAMETER	SYMBOL	RATINGS	UNIT
Supply Voltage	V_{SS}	2.7 to 5.5	V
Temperature Range		$-40 \leq T_J \leq 85$	°C

■ THERMAL DATA

PARAMETER	SYMBOL	RATINGS	UNIT
Thermal Resistance (Note 8)	θ_{JA}	235	°C/W

■ 2.7V DC ELECTRICAL CHARACTERISTICS

Unless otherwise specified, all limits guaranteed for $T_J = 25^\circ\text{C}$, $V^1 = 2.7\text{V}$, $V = 0\text{V}$, $V_{CM} = 1.0\text{V}$, $V_{OUT} = V^1/2$ and $R_L = 1\text{M}\Omega$

PARAMETER	SYMBOL	CONDITIONS	MIN	TYP	MAX	UNIT
Input Offset Voltage	V_{OS}			1.7	7	mV
Input Offset Voltage Average Drift	TCV_{OS}			5		$\mu\text{V}/^\circ\text{C}$
Input Bias Current	$I_{I(BIAS)}$			11	250	nA
Input Offset Current	$I_{I(OFF)}$			5	50	nA
Common Mode Rejection Ratio	CMRR	$0\text{V} \leq V_{CM} \leq 1.7\text{V}$	50	63		dB
Power Supply Rejection Ratio	PSRR	$2.7\text{V} \leq V^1 \leq 5\text{V}$ $V_{OUT} = 1\text{V}$	50	60		dB
Input Common-Mode Voltage Range	V_{CM}	For CMRR $\geq 50\text{dB}$	0	-0.2		V
				1.9	1.7	V
Output Swing	V_{OUT}	$R_L = 10\text{k}\Omega$ to 1.35V	$V^1 - 100$	$V^1 - 10$		mV
				60	180	mV
Supply Current	I_{SS}	Both amplifiers		140	340	μA

■ 2.7V AC ELECTRICAL CHARACTERISTICS

Unless otherwise specified, all limits guaranteed for $T_J = 25^\circ\text{C}$, $V^1 = 2.7\text{V}$, $V = 0\text{V}$, $V_{CM} = 1.0\text{V}$, $V_{OUT} = V^1/2$ and $R_L > 1\text{M}\Omega$

PARAMETER	SYMBOL	CONDITIONS	MIN	TYP	MAX	UNIT
Gain-Bandwidth Product	GBWP	$C_L = 200\text{pF}$		1		MHz
Phase Margin	$\Phi(T)$			60		Deg
Gain Margin	G(r)			10		dB
Input-Referred Voltage Noise	θ_{r1}	$F = 1\text{kHz}$		46		$\frac{\text{nV}}{\sqrt{\text{Hz}}}$
Input-referred Current Noise	I_{r1}	$F = 1\text{kHz}$		0.17		$\frac{\text{pA}}{\sqrt{\text{Hz}}}$

■ 5V DC ELECTRICAL CHARACTERISTICS

Unless otherwise specified, all limits guaranteed for $T_J = 25^\circ\text{C}$, $V^1 = 5\text{V}$, $V = 0\text{V}$, $V_{\text{CM}} = 2.0\text{V}$, $V_{\text{OUT}} = V^1/2$ and $R_L > 1\text{M}\Omega$. Boldface limits apply at the temperature extremes.

PARAMETER	SYMBOL	CONDITIONS	MIN	TYP	MAX	UNIT
Input Offset Voltage	V_{OS}		7	1.7	9	mV
Input Offset Voltage Average Drift	TCV_{OS}			5		$\mu\text{V}/^\circ\text{C}$
Input Bias Current	$I_{\text{I(BIAS)}}$		250	15	500	nA
Input Offset Current	$I_{\text{I(OFF)}}$		50	5	150	nA
Common Mode Rejection Ratio	CMRR	$0\text{V} \leq V_{\text{CM}} \leq 4\text{V}$	50	65		dB
Power Supply Rejection Ratio	PSRR	$2.7\text{V} \leq V^1 \leq 5\text{V}$ $V_{\text{OUT}} = 1\text{V}$ $V_{\text{CM}} = 1\text{V}$	50	60		dB
Input Common-Mode Voltage Range	V_{CM}	For CMRR $\geq 50\text{dB}$	0	-0.2		V
				4.2	4	V
Large Signal Voltage Gain(Note 6)	A_v	$R_L = 2\text{k}\Omega$	10	100	15	V/mV
Output Swing	V_{OUT}	$R_L = 2\text{k}\Omega$ to 2.5V	$V^+ - 400$	$V^1 - 40$	$V^1 - 300$	mV
			300	120	400	mV
		$R_L = 10\text{k}\Omega$ to 2.5V	$V^+ - 200$	$V^1 - 10$	$V^1 - 100$	mV
Output Short Circuit Current	I_{OUT}	Sourcing, $V_{\text{OUT}} = 0\text{V}$	5	60		mA
		Sinking, $V_{\text{OUT}} = 5\text{V}$	10	160		mA
Supply Current	I_{SS}	Both amplifiers	440	210	615	μA

■ 2.5V AC ELECTRICAL CHARACTERISTICS

Unless otherwise specified, all limits guaranteed for $T_J = 25^\circ\text{C}$, $V^1 = 2.7\text{V}$, $V = 0\text{V}$, $V_{\text{CM}} = 2.0\text{V}$, $V_{\text{OUT}} = V^1/2$ and $R_L > 1\text{M}\Omega$

PARAMETER	SYMBOL	CONDITIONS	MIN	TYP	MAX	UNIT
Slew Rate	SR			1		V/ μs
Gain-Bandwidth Product	GBWP	$C_L = 200\text{pF}$		1		MHz
Phase Margin	$\Phi(T)$			60		Deg
Gain Margin	$G(r)$			10		dB
Input-Referred Voltage Noise	θ_{r1}	$f = 1\text{kHz}$		39		$\frac{\text{nV}}{\sqrt{\text{Hz}}}$
Input-referred Current Noise	I_{r1}	$f = 1\text{kHz}$		0.21		$\frac{\text{pA}}{\sqrt{\text{Hz}}}$

Note1: Absolute Maximum Ratings indicate limits beyond which damage to the device may occur. Operating Ratings indicate conditions for which the device is intended to be functional, but specific performances is not guaranteed. For guaranteed specifications and the test conditions, see the Electrical Characteristics.

Note2: Human body model 1.5k Ω in series with 100pF. Machine model, 0 Ω in series with 200pF.

Note3: Shorting output to V^1 will adversely affect reliability.

Note4: Shorting output to V^+ will adversely affect reliability.

Note5: The maximum power dissipation is a function of $T_J(\text{max})$, θ_{JA} and T_A . The maximum allowable power dissipation at any ambient temperature is $P_D = (T_J(\text{max}) - T_A) / \theta_{\text{JA}}$. All numbers apply for packages soldered directly into a PC board.

Note6: R_L is connected to V. The output voltage is $0.5\text{V} \leq V_{\text{OUT}} \leq 4.5\text{V}$.

Note7: Connected as voltage follower with 3V step input. Number specified is these lower of the positive and negative slew rates.

Note8: all numbers are typical, and apply for packages soldered directly note a PC board is still air.

■ TYPICAL CHARACTERISTICS

(Unless otherwise specified, $V_E=+5V$, single supply. $T_A=25^\circ C$)

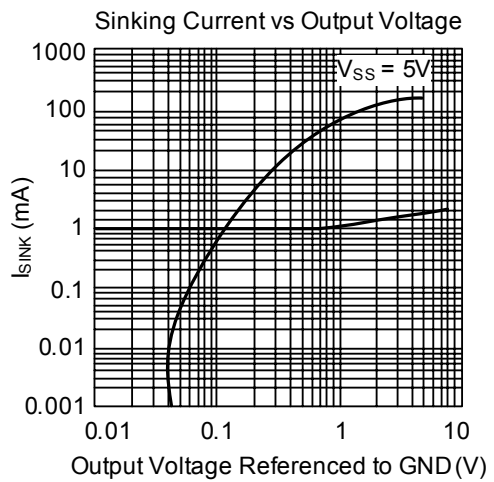
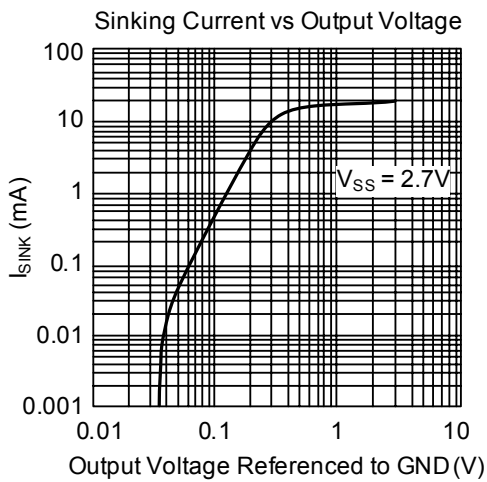
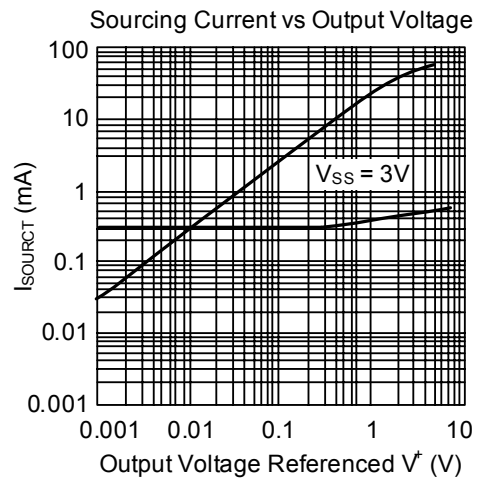
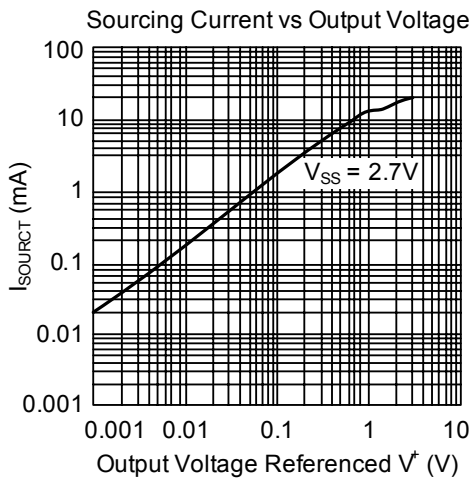
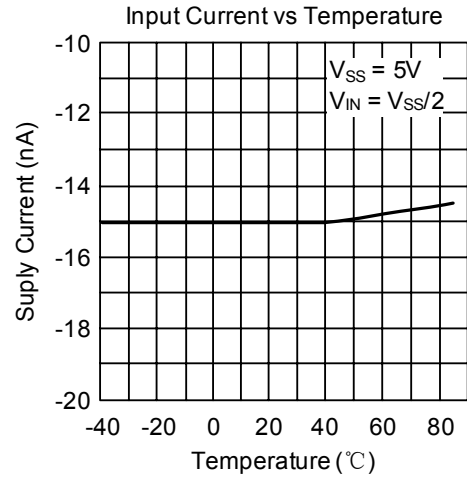
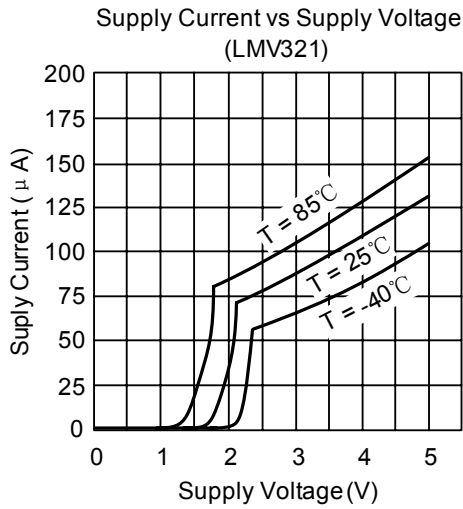

■ TYPICAL CHARACTERISTICS(Cont.)

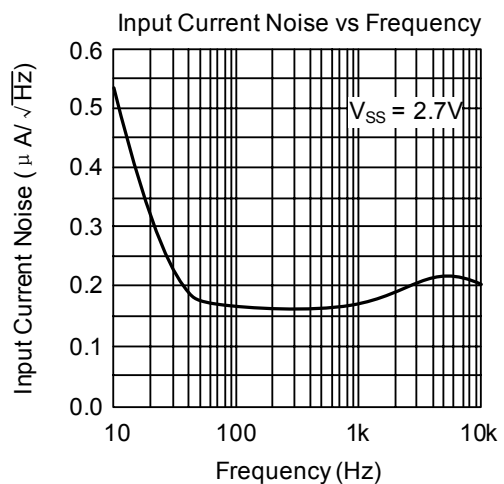
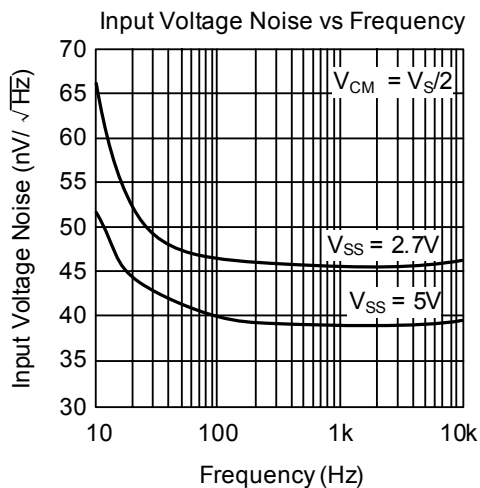
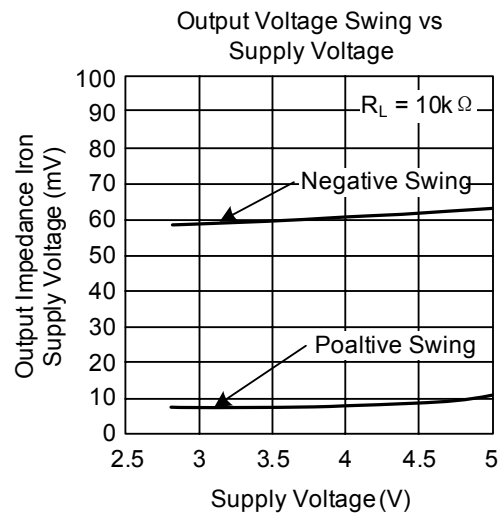
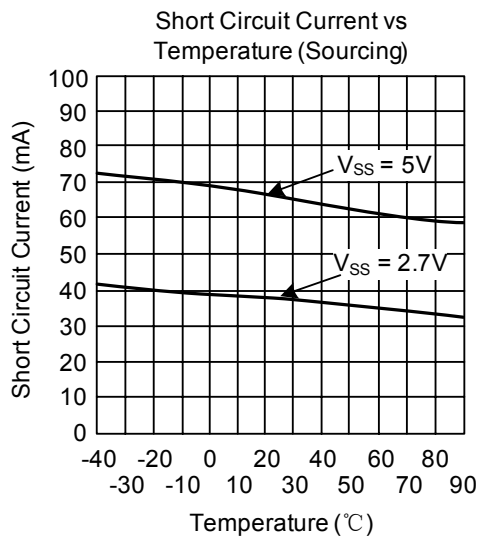
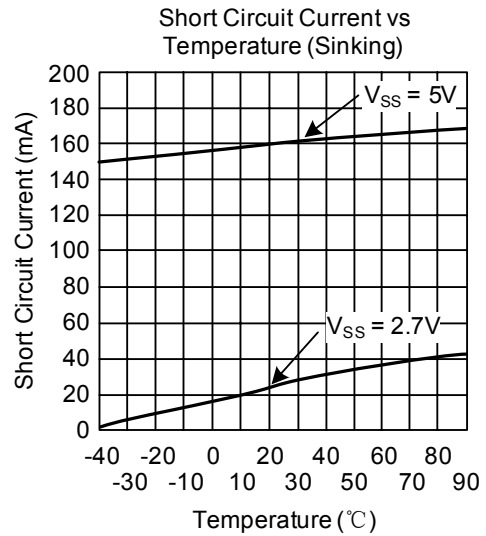
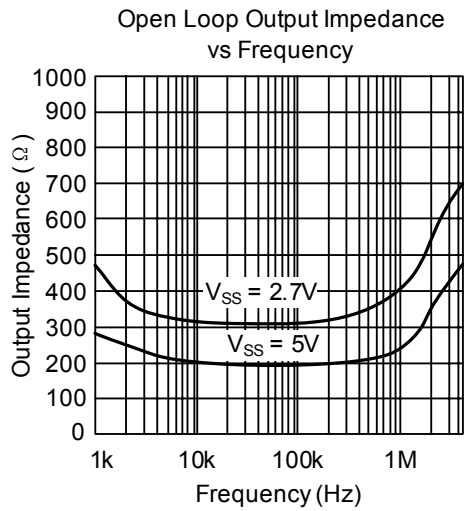

■ TYPICAL CHARACTERISTICS(Cont.)

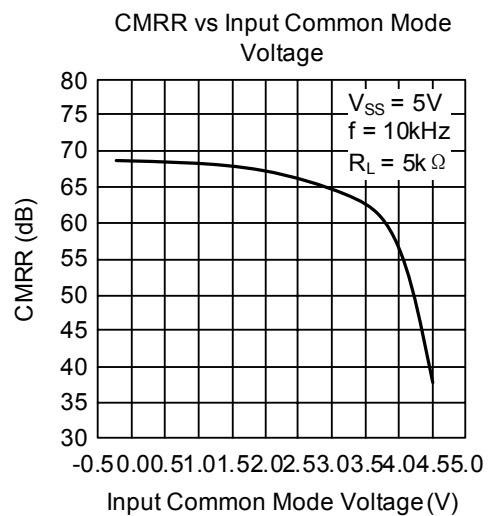
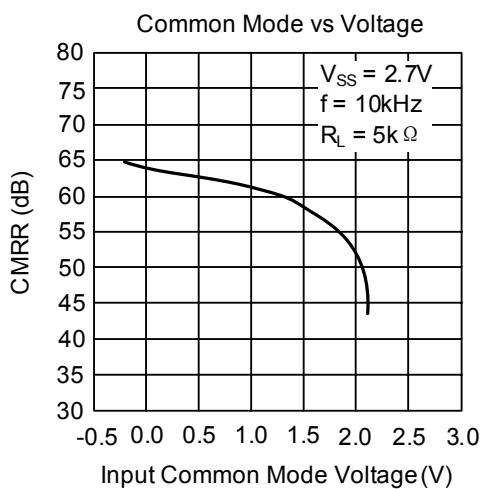
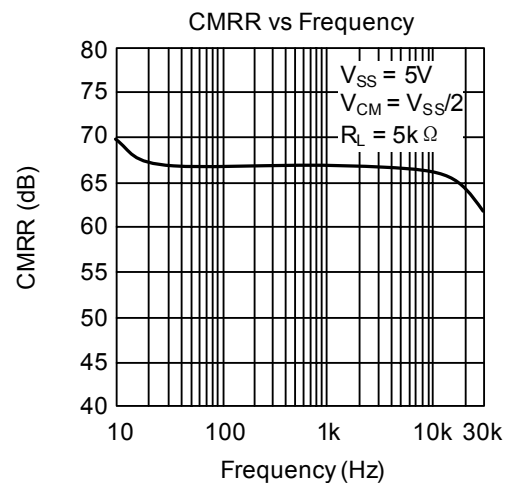
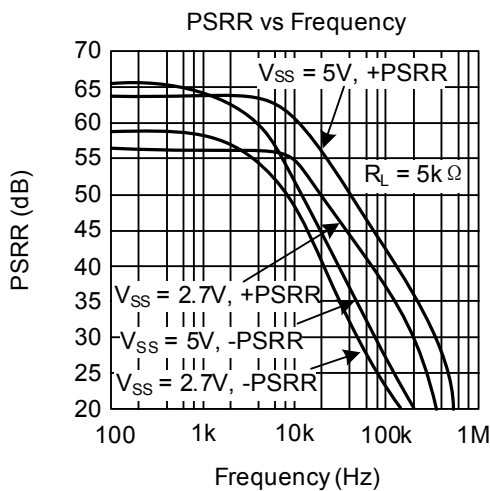
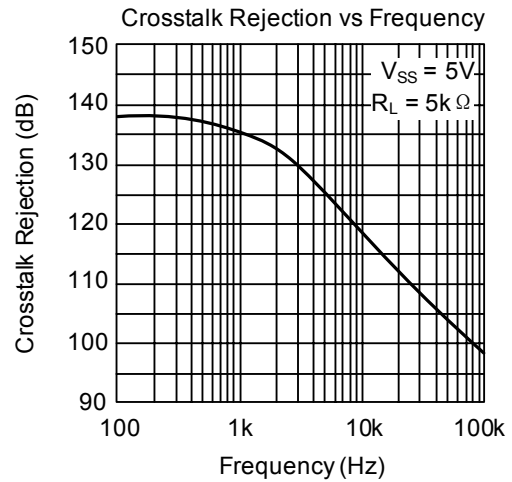
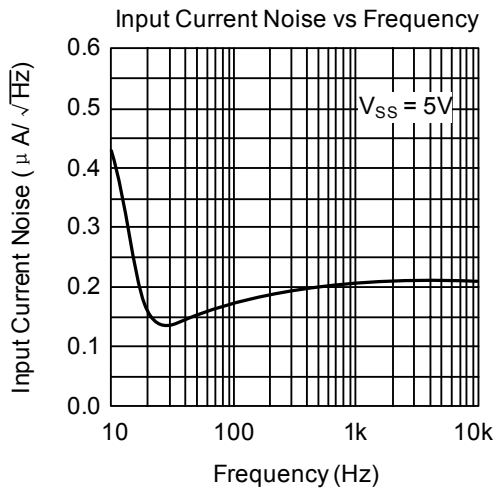

■ TYPICAL CHARACTERISTICS(Cont.)

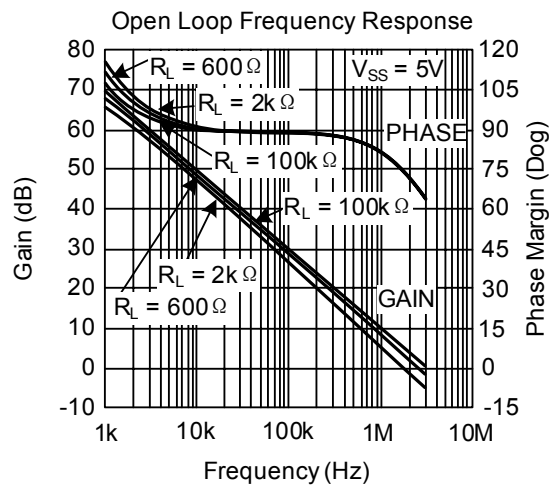
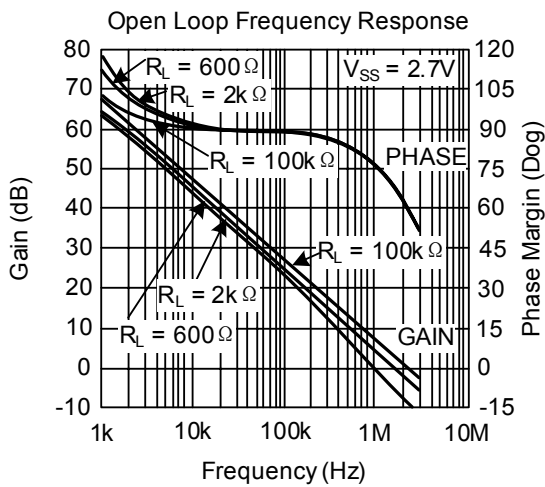
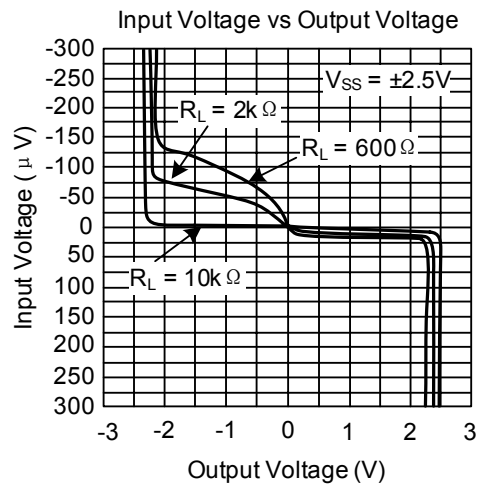
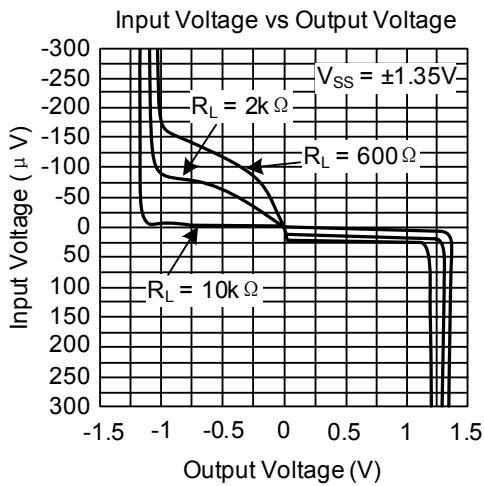
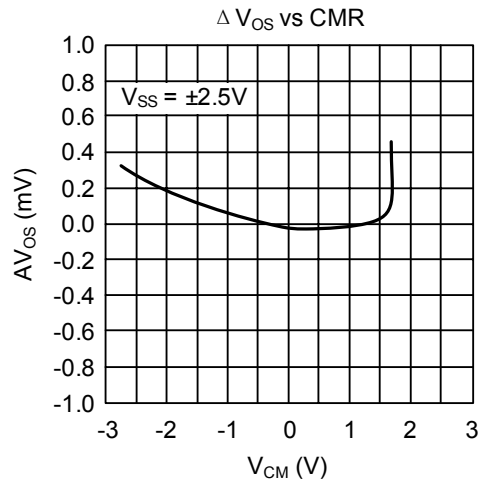
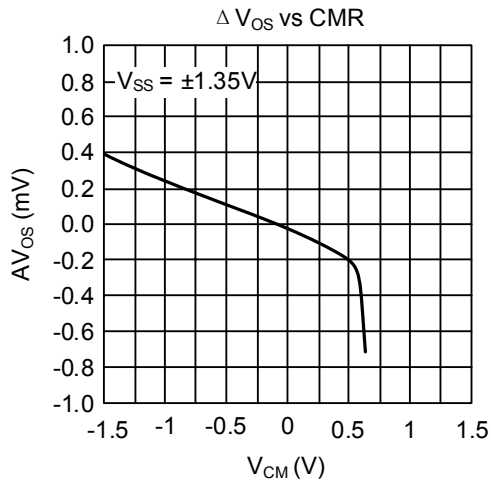

■ TYPICAL CHARACTERISTICS(Cont.)

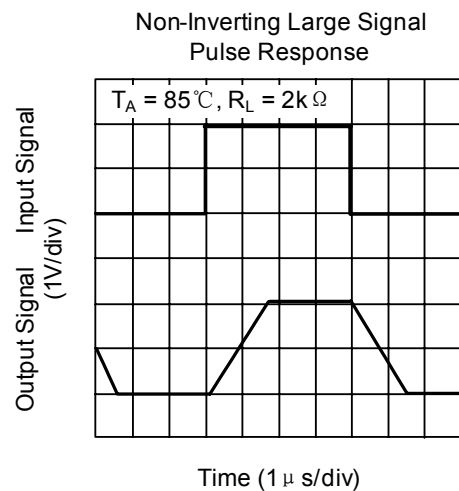
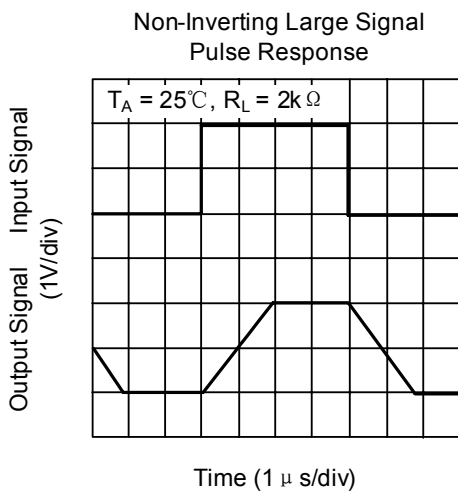
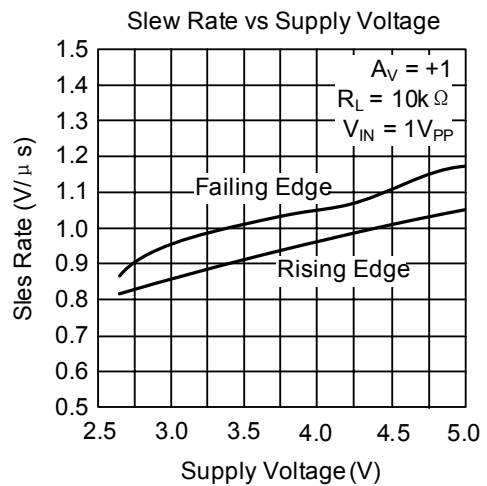
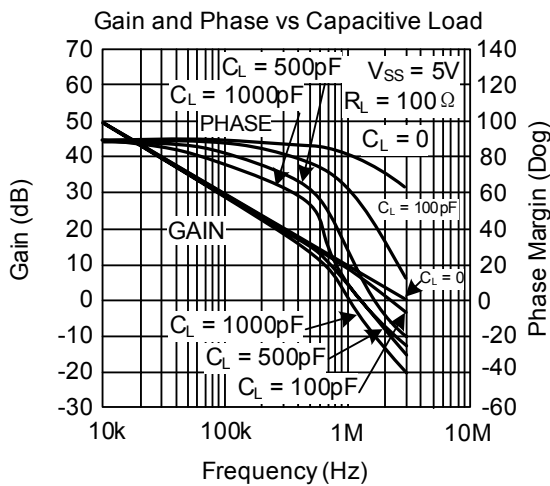
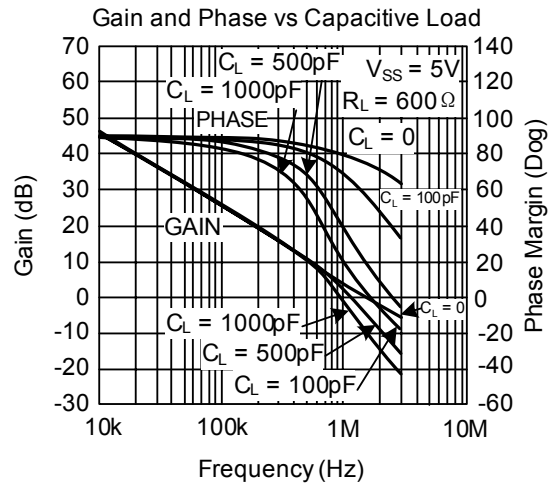
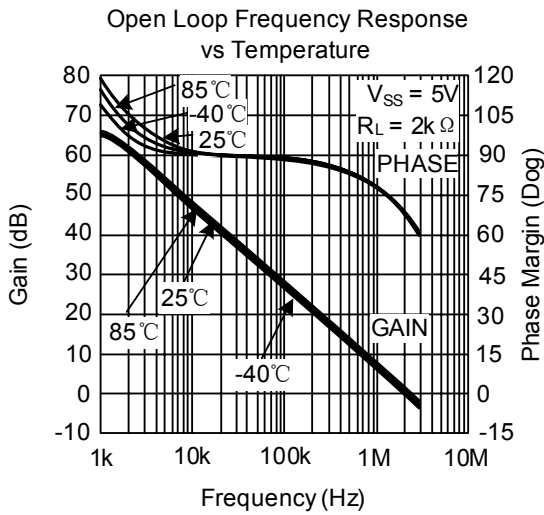

■ TYPICAL CHARACTERISTICS(Cont.)

Non-Inverting Large Signal Pulse Response

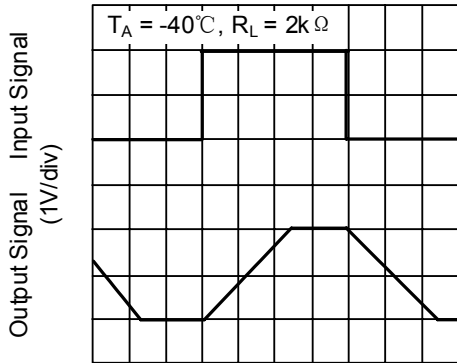

Time (1 μ s/div)

Non-Inverting Small Signal Pulse Response

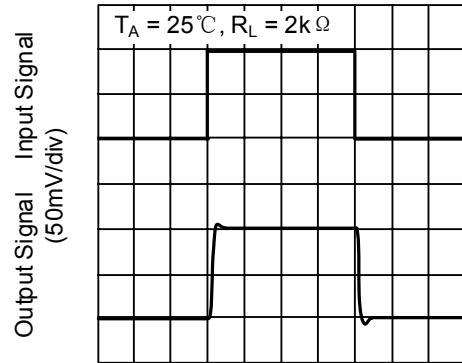

Time (1 μ s/div)

Non-Inverting Small Signal Pulse Response

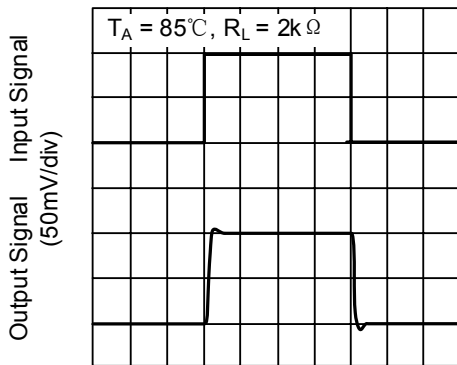

Time (1 μ s/div)

Non-Inverting Small Signal Pulse Response

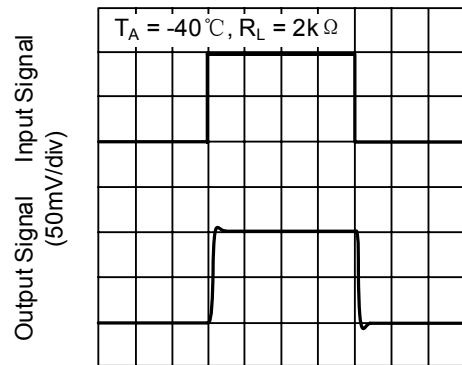

Time (1 μ s/div)

Non-Inverting Large Signal Pulse Response

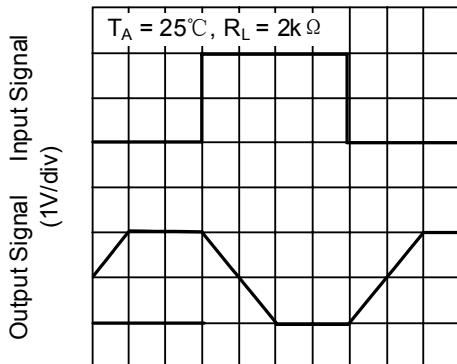

Time (1 μ s/div)

Non-Inverting Large Signal Pulse Response

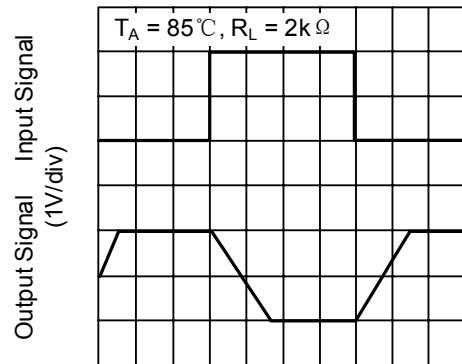

Time (1 μ s/div)

■ TYPICAL CHARACTERISTICS(Cont.)

Non-Inverting Large Signal Pulse Response

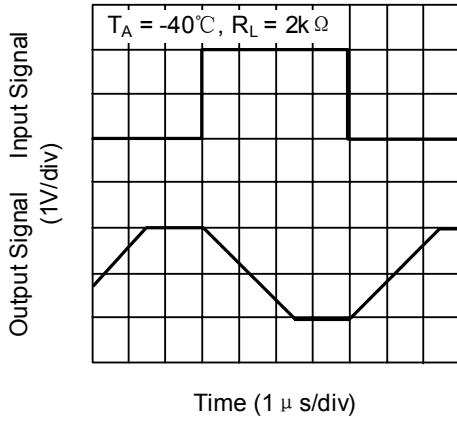

Non-Inverting Small Signal Pulse Response

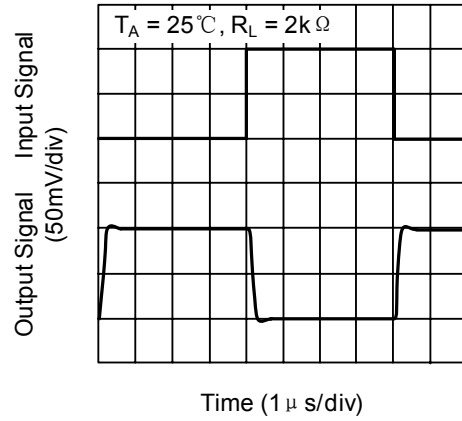

Non-Inverting Small Signal Pulse Response

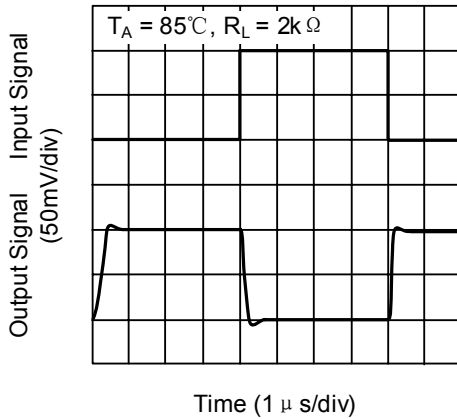

Non-Inverting Small Signal Pulse Response

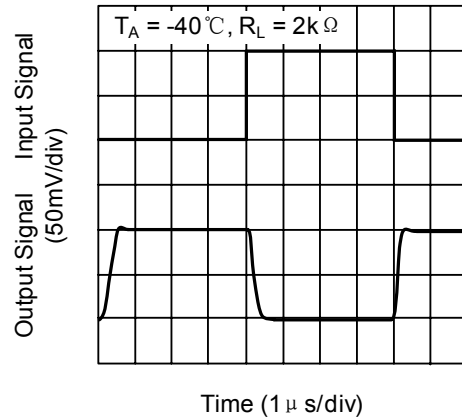

Stability vs Capacitive Load

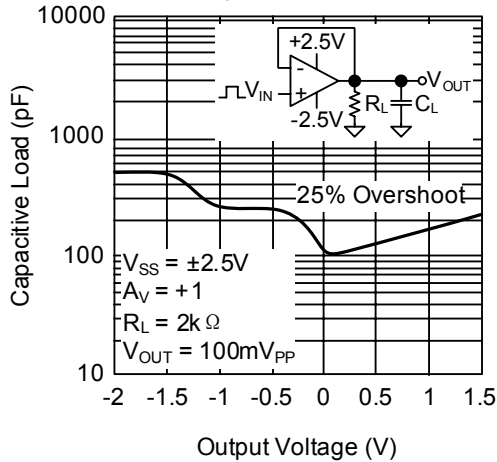

Stability vs Capacitive Load

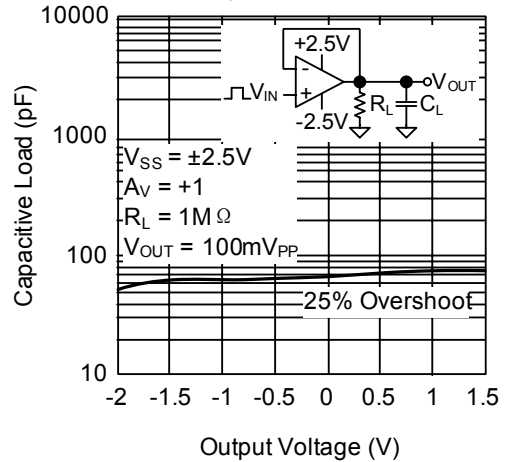

■ TYPICAL CHARACTERISTICS(Cont.)

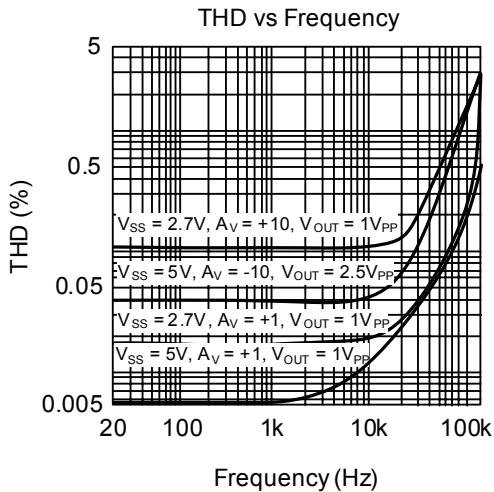
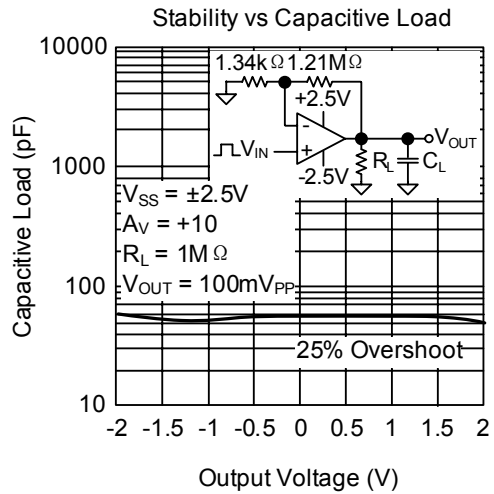
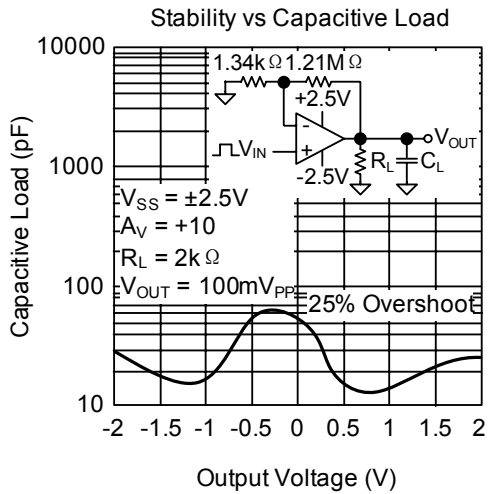

UTC assumes no responsibility for equipment failures that result from using products at values that exceed, even momentarily, rated values (such as maximum ratings, operating condition ranges, or other parameters) listed in products specifications of any and all UTC products described or contained herein. UTC products are not designed for use in life support appliances, devices or systems where malfunction of these products can be reasonably expected to result in personal injury. Reproduction in whole or in part is prohibited without the prior written consent of the copyright owner. The information presented in this document does not form part of any quotation or contract, is believed to be accurate and reliable and may be changed without notice.