

PRODUCT SPECIFICATIONS

SHARP®

Integrated Circuits Group

LRS1383C

Flash Memory

32M(X16) Flash Memory+8M(x16)SRAM

(Model No.: LRS1383C)

Spec No.: EL13X027A

Issue Date: February 14, 2002

- Handle this document carefully for it contains material protected by international copyright law. Any reproduction, full or in part, of this material is prohibited without the express written permission of the company.
 - When using the products covered herein, please observe the conditions written herein and the precautions outlined in the following paragraphs. In no event shall the company be liable for any damages resulting from failure to strictly adhere to these conditions and precautions.
- (1) The products covered herein are designed and manufactured for the following application areas. When using the products covered herein for the equipment listed in Paragraph (2), even for the following application areas, be sure to observe the precautions given in Paragraph (2). Never use the products for the equipment listed in Paragraph (3).
- Office electronics
 - Instrumentation and measuring equipment
 - Machine tools
 - Audiovisual equipment
 - Home appliance
 - Communication equipment other than for trunk lines
- (2) Those contemplating using the products covered herein for the following equipment which demands high reliability, should first contact a sales representative of the company and then accept responsibility for incorporating into the design fail-safe operation, redundancy, and other appropriate measures for ensuring reliability and safety of the equipment and the overall system.
- Control and safety devices for airplanes, trains, automobiles, and other transportation equipment
 - Mainframe computers
 - Traffic control systems
 - Gas leak detectors and automatic cutoff devices
 - Rescue and security equipment
 - Other safety devices and safety equipment, etc.
- (3) Do not use the products covered herein for the following equipment which demands extremely high performance in terms of functionality, reliability, or accuracy.
- Aerospace equipment
 - Communications equipment for trunk lines
 - Control equipment for the nuclear power industry
 - Medical equipment related to life support, etc.
- (4) Please direct all queries and comments regarding the interpretation of the above three Paragraphs to a sales representative of the company.
- Please direct all queries regarding the products covered herein to a sales representative of the company.

Contents

1. Description.....	3
2. Pin Configuration.....	4
3. Truth Table	6
3.1 Bus Operation.....	6
3.2 Simultaneous Operation Modes Allowed with Four Planes	7
4. Block Diagram.....	8
5. Command Definitions for Flash Memory	9
5.1 Command Definitions	9
5.2 Identifier Codes for Read Operation	11
5.3 Functions of Block Lock and Block Lock-Down.....	12
5.4 Block Locking State Transitions upon Command Write	12
5.5 Block Locking State Transitions upon F-WP Transition	13
6. Status Register Definition	14
7. Memory Map for Flash Memory	17
8. Absolute Maximum Ratings	18
9. Recommended DC Operating Conditions	18
10. Pin Capacitance	18
11. DC Electrical Characteristics	19
12. AC Electrical Characteristics for Flash Memory	21
12.1 AC Test Conditions	21
12.2 Read Cycle	21
12.3 Write Cycle (F-WE / F-CE Controlled)	22
12.4 Block Erase, Full Chip Erase, (Page Buffer) Program Performance	23
12.5 Flash Memory AC Characteristics Timing Chart	24
12.6 Reset Operations	27
13. AC Electrical Characteristics for SRAM	28
13.1 AC Test Conditions	28
13.2 Read Cycle	28
13.3 Write Cycle	29
13.4 SRAM AC Characteristics Timing Chart.....	30
14. Data Retention Characteristics for SRAM.....	34
15. Notes	35
16. Flash Memory Data Protection	36
17. Design Considerations	37
18. Related Document Information	37
19. Package and Packing Specification	38

2. Pin Configuration

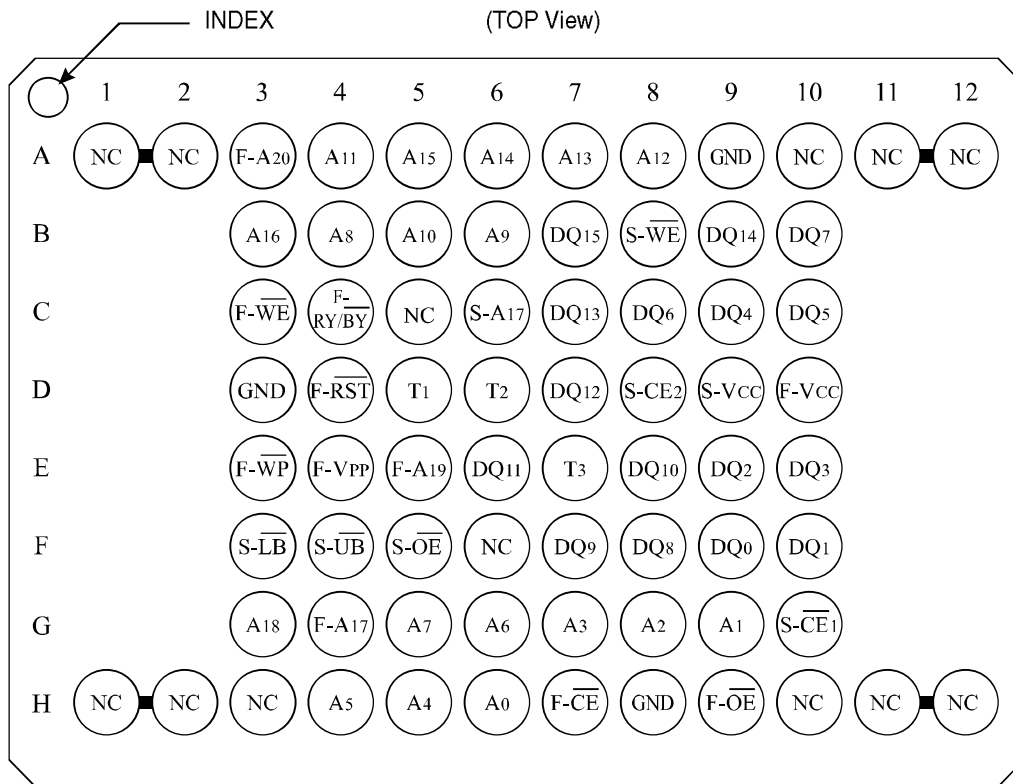

Note) From T1 to T3 pins are needed to be open.
 Two NC pins at the corner are connected.
 Do not float any GND pins.

Pin	Description	Type
A ₀ to A ₁₆ , A ₁₈	Address Inputs (Common)	Input
F-A ₁₇ , F-A ₁₉ , F-A ₂₀	Address Inputs (Flash)	Input
S-A ₁₇	Address Input (SRAM)	Input
F- \overline{CE}	Chip Enable Input (Flash)	Input
S- \overline{CE}_1 , S- \overline{CE}_2	Chip Enable Inputs (SRAM)	Input
F- \overline{WE}	Write Enable Input (Flash)	Input
S- \overline{WE}	Write Enable Input (SRAM)	Input
F- \overline{OE}	Output Enable Input (Flash)	Input
S- \overline{OE}	Output Enable Input (SRAM)	Input
S- \overline{LB}	SRAM Byte Enable Input (DQ ₀ to DQ ₇)	Input
S- \overline{UB}	SRAM Byte Enable Input (DQ ₈ to DQ ₁₅)	Input
F- \overline{RST}	Reset Power Down Input (Flash) Block erase and Write : V _{IH} Read : V _{IH} Reset Power Down : V _{IL}	Input
F- \overline{WP}	Write Protect Input (Flash) When F- \overline{WP} is V _{IL} , locked-down blocks cannot be unlocked. Erase or program operation can be executed to the blocks which are not locked and locked-down. When F- \overline{WP} is V _{IH} , lock-down is disabled.	Input
F-RY/ \overline{BY}	Ready/Busy Output (Flash) During an Erase or Write operation : V _{OL} Block Erase and Write Suspend : High-Z (High impedance)	Open Drain Output
DQ ₀ to DQ ₁₅	Data Inputs and Outputs (Common)	Input / Output
F-V _{CC}	Power Supply (Flash)	Power
S-V _{CC}	Power Supply (SRAM)	Power
F-V _{PP}	Monitoring Power Supply Voltage (Flash) Block Erase and Write : F-V _{PP} = V _{PPH1/2} All Blocks Locked : F-V _{PP} < V _{PPLK}	Input
GND	GND (Common)	Power
NC	Non Connection	-
T ₁ to T ₃	Test pins (Should be all open)	-

3. Truth Table

3.1 Bus Operation⁽¹⁾

Flash	SRAM	Notes	F- \overline{CE}	F- \overline{RST}	F- \overline{OE}	F- \overline{WE}	S- \overline{CE}_1	S- \overline{CE}_2	S- \overline{OE}	S- \overline{WE}	S- \overline{LB}	S- \overline{UB}	DQ ₀ to DQ ₁₅	
Read	Standby	3,5	L	H	L	H	(8)		X	X	(8)		(7)	
Output Disable		5			H								High-Z	
Write		2,3,4,5			L								D _{IN}	
Standby	Read	5	H	H	X	X	L	H	L	H	(9)		High-Z	
	Output Disable	5							H	H	X	X		High-Z
	Write	5							X	X	H	H		
Reset Power Down	Read	5,6	X	L	X	X	L	H	L	H	(9)		High-Z	
	Output Disable	5,6							H	H	X	X		High-Z
	Write	5,6							X	X	H	H		
Standby	Standby	5	H	H	X	X	(8)		X	X	(8)		High-Z	
Reset Power Down		5,6	X	L										

Notes:

1. L = V_{IL}, H = V_{IH}, X = H or L, High-Z = High impedance. Refer to the DC Characteristics.
2. Command writes involving block erase, (page buffer) program are reliably executed when F-V_{PP} = V_{PPH1/2} and F-V_{CC} = 2.7V to 3.3V.
Command writes involving full chip erase is reliably executed when F-V_{PP} = V_{PPH1} and F-V_{CC} = 2.7V to 3.3V.
Block erase, full chip erase, (page buffer) program with F-V_{PP} < V_{PPH1/2} (Min.) produce spurious results and should not be attempted.
3. Never hold F- \overline{OE} low and F- \overline{WE} low at the same timing.
4. Refer Section 5. Command Definitions for Flash Memory valid D_{IN} during a write operation.
5. F- \overline{WP} set to V_{IL} or V_{IH}.
6. Electricity consumption of Flash Memory is lowest when F- \overline{RST} = GND ±0.2V.
7. Flash Read Mode

Mode	Address	DQ ₀ to DQ ₁₅
Read Array	X	D _{OUT}
Read Identifier Codes	See 5.2	See 5.2
Read Query	Refer to the Appendix	Refer to the Appendix

8. SRAM Standby Mode

S- \overline{CE}_1	S- \overline{CE}_2	S- \overline{LB}	S- \overline{UB}
H	X	X	X
X	L	X	X
X	X	H	H

9. S- \overline{UB} , S- \overline{LB} Control Mode

S- \overline{LB}	S- \overline{UB}	DQ ₀ to DQ ₇	DQ ₈ to DQ ₁₅
L	L	D _{OUT} /D _{IN}	D _{OUT} /D _{IN}
L	H	D _{OUT} /D _{IN}	High-Z
H	L	High-Z	D _{OUT} /D _{IN}

3.2 Simultaneous Operation Modes Allowed with Four Planes^(1, 2)

IF ONE PARTITION IS:	THEN THE MODES ALLOWED IN THE OTHER PARTITION IS:									
	Read Array	Read ID	Read Status	Read Query	Word Program	Page Buffer Program	Block Erase	Full Chip Erase	Program Suspend	Block Erase Suspend
Read Array	X	X	X	X	X	X	X		X	X
Read ID	X	X	X	X	X	X	X		X	X
Read Status	X	X	X	X	X	X	X	X	X	X
Read Query	X	X	X	X	X	X	X		X	X
Word Program	X	X	X	X						X
Page Buffer Program	X	X	X	X						X
Block Erase	X	X	X	X						
Full Chip Erase			X							
Program Suspend	X	X	X	X						X
Block Erase Suspend	X	X	X	X	X	X			X	

Notes:

1. "X" denotes the operation available.
2. Configurative Partition Dual Work Restrictions:
 Status register reflects partition state, not WSM (Write State Machine) state - this allows a status register for each partition.
 Only one partition can be erased or programmed at a time - no command queuing.
 Commands must be written to an address within the block targeted by that command.

4. Block Diagram

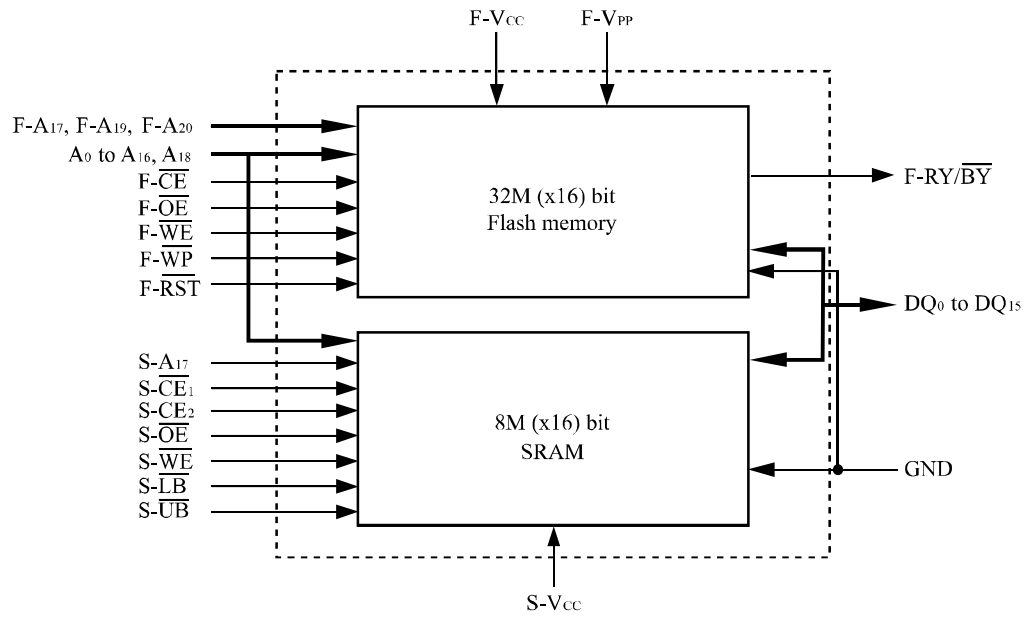

5. Command Definitions for Flash Memory⁽¹¹⁾

5.1 Command Definitions

Command	Bus Cycles Req'd	Notes	First Bus Cycle			Second Bus Cycle		
			Oper ⁽¹⁾	Address ⁽²⁾	Data ⁽³⁾	Oper ⁽¹⁾	Address ⁽²⁾	Data ⁽³⁾
Read Array	1	2	Write	PA	FFH			
Read Identifier Codes	≥ 2	2,3,4	Write	PA	90H	Read	IA	ID
Read Query	≥ 2	2,3,4	Write	PA	98H	Read	QA	QD
Read Status Register	2	2,3	Write	PA	70H	Read	PA	SRD
Clear Status Register	1	2	Write	PA	50H			
Block Erase	2	2,3,5	Write	BA	20H	Write	BA	D0H
Full Chip Erase	2	2,5,9	Write	X	30H	Write	X	D0H
Program	2	2,3,5,6	Write	WA	40H or 10H	Write	WA	WD
Page Buffer Program	≥ 4	2,3,5,7	Write	WA	E8H	Write	WA	N-1
Block Erase and (Page Buffer) Program Suspend	1	2,8,9	Write	PA	B0H			
Block Erase and (Page Buffer) Program Resume	1	2,8,9	Write	PA	D0H			
Set Block Lock Bit	2	2	Write	BA	60H	Write	BA	01H
Clear Block Lock Bit	2	2,10	Write	BA	60H	Write	BA	D0H
Set Block Lock-down Bit	2	2	Write	BA	60H	Write	BA	2FH
Set Partition Configuration Register	2	2,3	Write	PCRC	60H	Write	PCRC	04H

Notes:

- Bus operations are defined in 3.1 Bus Operation.
- The address which is written at the first bus cycle should be the same as the address which is written at the second bus cycle.
 X=Any valid address within the device.
 PA=Address within the selected partition.
 IA=Identifier codes address (See 5.2 Identifier Codes for Read Operation).
 QA=Query codes address. Refer to the LH28F320BF, LH28F640BF series Appendix for details.
 BA=Address within the block being erased, set/cleared block lock bit or set block lock-down bit.
 WA=Address of memory location for the Program command or the first address for the Page Buffer Program command.
 PCRC=Partition configuration register code presented on the address A₀-A₁₅.
- ID=Data read from identifier codes (See 5.2 Identifier Codes for Read Operation).
 QD=Data read from query database. Refer to the LH28F320BF, LH28F640BF series Appendix for details.
 SRD=Data read from status register. See 6. Status Register Definition for a description of the status register bits.
 WD=Data to be programmed at location WA. Data is latched on the rising edge of F-WE or F-CE (whichever goes high first).
 N-1=N is the number of the words to be loaded into a page buffer.
- Following the Read Identifier Codes command, read operations access manufacturer code, device code, block lock configuration code, partition configuration register code (See 5.2 Identifier Codes for Read Operation).
 The Read Query command is available for reading CFI (Common Flash Interface) information.
- Block erase, full chip erase or (page buffer) program cannot be executed when the selected block is locked. Unlocked block can be erased or programmed when F-RST is V_{IH}.
- Either 40H or 10H are recognized by the CUI (Command User Interface) as the program setup.
- Following the third bus cycle, inputs the program sequential address and write data of "N" times. Finally, input the any valid address within the target partition to be programmed and the confirm command (D0H). Refer to the LH28F320BF, LH28F640BF series Appendix for details.

8. If the program operation in one partition is suspended and the erase operation in other partition is also suspended, the suspended program operation should be resumed first, and then the suspended erase operation should be resumed next.
9. Full chip erase operation can not be suspended.
10. Following the Clear Block Lock Bit command, block which is not locked-down is unlocked when $F\text{-}\overline{WP}$ is V_{IL} .
When $F\text{-}\overline{WP}$ is V_{IH} , lock-down bit is disabled and the selected block is unlocked regardless of lock-down configuration.
11. Commands other than those shown above are reserved by SHARP for future device implementations and should not be used.

5.2 Identifier Codes for Read Operation

	Code	Address [A ₁₅ -A ₀] ⁽⁴⁾	Data [DQ ₁₅ -DQ ₀]	Notes
Manufacturer Code	Manufacturer Code	0000H	00B0H	
Device Code	32M Bottom Parameter Device Code	0001H	00B5H	1
Block Lock Configuration Code	Block is Unlocked	Block Address + 2	DQ ₀ = 0	2
	Block is Locked		DQ ₀ = 1	2
	Block is not Locked-Down		DQ ₁ = 0	2
	Block is Locked-Down		DQ ₁ = 1	2
Device Configuration Code	Partition Configuration Register	0006H	PCRC	3

Notes:

1. Bottom parameter device has its parameter blocks in the plane 0 (The lowest address).
2. DQ₁₅-DQ₂ is reserved for future implementation.
3. PCRC=Partition Configuration Register Code.
4. The address A₂₀-A₁₆ are shown in below table for reading the manufacturer, device, lock configuration, device configuration code.
The address to read the identifier codes is dependent on the partition which is selected when writing the Read Identifier Codes command (90H).
See Chapter 6. Partition Configuration Register Definition (P.15) for the partition configuration register.

Identifier Codes for Read Operation on Partition Configuration (32M-bit device)

Partition Configuration Register			Address (32M-bit device) [A ₂₀ -A ₁₆]
PCR.10	PCR.9	PCR.8	
0	0	0	00H
0	0	1	00H or 08H
0	1	0	00H or 10H
1	0	0	00H or 18H
0	1	1	00H or 08H or 10H
1	1	0	00H or 10H or 18H
1	0	1	00H or 08H or 18H
1	1	1	00H or 08H or 10H or 18H

5.3 Functions of Block Lock and Block Lock-Down

Current State					Erase/Program Allowed ⁽²⁾
State	F- \overline{WP}	DQ ₁ ⁽¹⁾	DQ ₀ ⁽¹⁾	State Name	
[000]	0	0	0	Unlocked	Yes
[001] ⁽³⁾	0	0	1	Locked	No
[011]	0	1	1	Locked-down	No
[100]	1	0	0	Unlocked	Yes
[101] ⁽³⁾	1	0	1	Locked	No
[110] ⁽⁴⁾	1	1	0	Lock-down Disable	Yes
[111]	1	1	1	Lock-down Disable	No

Notes:

- DQ₀ = 1: a block is locked; DQ₀ = 0: a block is unlocked.
DQ₁ = 1: a block is locked-down; DQ₁ = 0: a block is not locked-down.
- Erase and program are general terms, respectively, to express: block erase, full chip erase and (page buffer) program operations.
- At power-up or device reset, all blocks default to locked state and are not locked-down, that is, [001] (F- \overline{WP} = 0) or [101] (F- \overline{WP} = 1), regardless of the states before power-off or reset operation.
- When F- \overline{WP} is driven to V_{IL} in [110] state, the state changes to [011] and the blocks are automatically locked.

5.4 Block Locking State Transitions upon Command Write⁽⁴⁾

Current State				Result after Lock Command Written (Next State)		
State	F- \overline{WP}	DQ ₁	DQ ₀	Set Lock ⁽¹⁾	Clear Lock ⁽¹⁾	Set Lock-down ⁽¹⁾
[000]	0	0	0	[001]	No Change	[011] ⁽²⁾
[001]	0	0	1	No Change ⁽³⁾	[000]	[011]
[011]	0	1	1	No Change	No Change	No Change
[100]	1	0	0	[101]	No Change	[111] ⁽²⁾
[101]	1	0	1	No Change	[100]	[111]
[110]	1	1	0	[111]	No Change	[111] ⁽²⁾
[111]	1	1	1	No Change	[110]	No Change

Notes:

- “Set Lock” means Set Block Lock Bit command, “Clear Lock” means Clear Block Lock Bit command and “Set Lock-down” means Set Block Lock-Down Bit command.
- When the Set Block Lock-Down Bit command is written to the unlocked block (DQ₀ = 0), the corresponding block is locked-down and automatically locked at the same time.
- “No Change” means that the state remains unchanged after the command written.
- In this state transitions table, assumes that F- \overline{WP} is not changed and fixed V_{IL} or V_{IH}.

5.5 Block Locking State Transitions upon $F\text{-}\overline{WP}$ Transition⁽⁴⁾

Previous State	Current State				Result after $F\text{-}\overline{WP}$ Transition (Next State)	
	State	$F\text{-}\overline{WP}$	DQ ₁	DQ ₀	$F\text{-}\overline{WP} = 0 \rightarrow 1$ ⁽¹⁾	$F\text{-}\overline{WP} = 1 \rightarrow 0$ ⁽¹⁾
-	[000]	0	0	0	[100]	-
-	[001]	0	0	1	[101]	-
[110] ⁽²⁾	[011]	0	1	1	[110]	-
Other than [110] ⁽²⁾					[111]	-
-	[100]	1	0	0	-	[000]
-	[101]	1	0	1	-	[001]
-	[110]	1	1	0	-	[011] ⁽³⁾
-	[111]	1	1	1	-	[011]

Notes:

1. " $F\text{-}\overline{WP} = 0 \rightarrow 1$ " means that $F\text{-}\overline{WP}$ is driven to V_{IH} and " $F\text{-}\overline{WP} = 1 \rightarrow 0$ " means that $F\text{-}\overline{WP}$ is driven to V_{IL} .
2. State transition from the current state [011] to the next state depends on the previous state.
3. When $F\text{-}\overline{WP}$ is driven to V_{IL} in [110] state, the state changes to [011] and the blocks are automatically locked.
4. In this state transitions table, assumes that lock configuration commands are not written in previous, current and next state.

6. Status Register Definition

Status Register Definition

R	R	R	R	R	R	R	R
15	14	13	12	11	10	9	8
WSMS	BESS	BEFCES	PBPS	VPPS	PBPSS	DPS	R
7	6	5	4	3	2	1	0

<p>SR.15 - SR.8 = RESERVED FOR FUTURE ENHANCEMENTS (R)</p> <p>SR.7 = WRITE STATE MACHINE STATUS (WSMS) 1 = Ready 0 = Busy</p> <p>SR.6 = BLOCK ERASE SUSPEND STATUS (BESS) 1 = Block Erase Suspended 0 = Block Erase in Progress/Completed</p> <p>SR.5 = BLOCK ERASE AND FULL CHIP ERASE STATUS (BEFCES) 1 = Error in Block Erase or Full Chip Erase 0 = Successful Block Erase or Full Chip Erase</p> <p>SR.4 = (PAGE BUFFER) PROGRAM STATUS (PBPS) 1 = Error in (Page Buffer) Program 0 = Successful (Page Buffer) Program</p> <p>SR.3 = F-V_{pp} STATUS (VPPS) 1 = F-V_{pp} LOW Detect, Operation Abort 0 = F-V_{pp} OK</p> <p>SR.2 = (PAGE BUFFER) PROGRAM SUSPEND STATUS (PBPSS) 1 = (Page Buffer) Program Suspended 0 = (Page Buffer) Program in Progress/Completed</p> <p>SR.1 = DEVICE PROTECT STATUS (DPS) 1 = Erase or Program Attempted on a Locked Block, Operation Abort 0 = Unlocked</p> <p>SR.0 = RESERVED FOR FUTURE ENHANCEMENTS (R)</p>	<p>Notes:</p> <p>Status Register indicates the status of the partition, not WSM (Write State Machine). Even if the SR.7 is "1", the WSM may be occupied by the other partition when the device is set to 2, 3 or 4 partitions configuration.</p> <p>Check SR.7 or F-RY/$\overline{\text{BY}}$ to determine block erase, full chip erase, (page buffer) program completion. SR.6 - SR.1 are invalid while SR.7= "0".</p> <p>If both SR.5 and SR.4 are "1"s after a block erase, full chip erase, page buffer program, set/clear block lock bit, set block lock-down bit or set partition configuration register attempt, an improper command sequence was entered.</p> <p>SR.3 does not provide a continuous indication of F-V_{pp} level. The WSM interrogates and indicates the F-V_{pp} level only after Block Erase, Full Chip Erase, (Page Buffer) Program command sequences. SR.3 is not guaranteed to report accurate feedback when F-V_{pp}≠V_{ppH1/2} or V_{ppLK}.</p> <p>SR.1 does not provide a continuous indication of block lock bit. The WSM interrogates the block lock bit only after Block Erase, Full Chip Erase, (Page Buffer) Program command sequences. It informs the system, depending on the attempted operation, if the block lock bit is set. Reading the block lock configuration codes after writing the Read Identifier Codes command indicates block lock bit status.</p> <p>SR.15 - SR.8 and SR.0 are reserved for future use and should be masked out when polling the status register.</p>
--	--

Extended Status Register Definition							
R	R	R	R	R	R	R	R
15	14	13	12	11	10	9	8
SMS	R	R	R	R	R	R	R
7	6	5	4	3	2	1	0
<p>XSR.15-8 = RESERVED FOR FUTURE ENHANCEMENTS (R)</p> <p>XSR.7 = STATE MACHINE STATUS (SMS) 1 = Page Buffer Program available 0 = Page Buffer Program not available</p> <p>XSR.6-0 = RESERVED FOR FUTURE ENHANCEMENTS (R)</p>				<p>Notes:</p> <p>After issue a Page Buffer Program command (E8H), XSR.7="1" indicates that the entered command is accepted. If XSR.7 is "0", the command is not accepted and a next Page Buffer Program command (E8H) should be issued again to check if page buffer is available or not.</p> <p>XSR.15-8 and XSR.6-0 are reserved for future use and should be masked out when polling the extended status register.</p>			

Partition Configuration Register Definition							
R	R	R	R	R	PC2	PC1	PC0
15	14	13	12	11	10	9	8
R	R	R	R	R	R	R	R
7	6	5	4	3	2	1	0
PCR.15-11 = RESERVED FOR FUTURE ENHANCEMENTS (R) PCR.10-8 = PARTITION CONFIGURATION (PC2-0) 000 = No partitioning. Dual Work is not allowed. 001 = Plane1-3 are merged into one partition. (default in a bottom parameter device) 010 = Plane 0-1 and Plane2-3 are merged into one partition respectively. 100 = Plane 0-2 are merged into one partition. (default in a top parameter device) 011 = Plane 2-3 are merged into one partition. There are three partitions in this configuration. Dual work operation is available between any two partitions. 110 = Plane 0-1 are merged into one partition. There are three partitions in this configuration. Dual work operation is available between any two partitions. 101 = Plane 1-2 are merged into one partition. There are three partitions in this configuration. Dual work operation is available between any two partitions.				111 = There are four partitions in this configuration. Each plane corresponds to each partition respectively. Dual work operation is available between any two partitions. PCR.7-0 = RESERVED FOR FUTURE ENHANCEMENTS (R) Notes: After power-up or device reset, PCR10-8 (PC2-0) is set to "001" in a bottom parameter device and "100" in a top parameter device. See the table below for more details. PCR.15-11 and PCR.7-0 are reserved for future use and should be masked out when polling the partition configuration register.			

Partition Configuration

PC2 PC1PC0	PARTITIONING FOR DUAL WORK	PC2 PC1PC0	PARTITIONING FOR DUAL WORK
0 0 0	PARTITION0 	0 1 1	PARTITION2 PARTITION1 PARTITION0
0 0 1	PARTITION1 PARTITION0 	1 1 0	PARTITION2 PARTITION1 PARTITION0
0 1 0	PARTITION1 PARTITION0 	1 0 1	PARTITION2 PARTITION1 PARTITION0
1 0 0	PARTITION1 PARTITION0 	1 1 1	PARTITION3 PARTITION2 PARTITION1 PARTITION0

7. Memory Map for Flash Memory

Bottom Parameter			BLOCK NUMBER	ADDRESS RANGE			
PLANE3 (UNIFORM PLANE)	70	32K-WORD	1F8000h - 1FFFFFh	PLANE1 (UNIFORM PLANE)	38	32K-WORD	0F8000h - 0FFFFFh
	69	32K-WORD	1F0000h - 1F7FFFh		37	32K-WORD	0F0000h - 0F7FFFh
	68	32K-WORD	1E8000h - 1EFFFFh		36	32K-WORD	0E8000h - 0EFFFFh
	67	32K-WORD	1E0000h - 1E7FFFh		35	32K-WORD	0E0000h - 0E7FFFh
	66	32K-WORD	1D8000h - 1DFFFFh		34	32K-WORD	0D8000h - 0DFFFFh
	65	32K-WORD	1D0000h - 1D7FFFh		33	32K-WORD	0D0000h - 0D7FFFh
	64	32K-WORD	1C8000h - 1CFFFFh		32	32K-WORD	0C8000h - 0CFFFFh
	63	32K-WORD	1C0000h - 1C7FFFh		31	32K-WORD	0C0000h - 0C7FFFh
	62	32K-WORD	1B8000h - 1BFFFFh		30	32K-WORD	0B8000h - 0BFFFFh
	61	32K-WORD	1B0000h - 1B7FFFh		29	32K-WORD	0B0000h - 0B7FFFh
	60	32K-WORD	1A8000h - 1AFFFFh		28	32K-WORD	0A8000h - 0AFFFFh
	59	32K-WORD	1A0000h - 1A7FFFh		27	32K-WORD	0A0000h - 0A7FFFh
	58	32K-WORD	198000h - 19FFFFh		26	32K-WORD	098000h - 09FFFFh
	57	32K-WORD	190000h - 197FFFh		25	32K-WORD	090000h - 097FFFh
PLANE2 (UNIFORM PLANE)	56	32K-WORD	188000h - 18FFFFh	24	32K-WORD	088000h - 08FFFFh	
	55	32K-WORD	180000h - 187FFFh	23	32K-WORD	080000h - 087FFFh	
	54	32K-WORD	178000h - 17FFFFh	PLANE0 (PARAMETER PLANE)	22	32K-WORD	078000h - 07FFFFh
	53	32K-WORD	170000h - 177FFFh		21	32K-WORD	070000h - 077FFFh
	52	32K-WORD	168000h - 16FFFFh		20	32K-WORD	068000h - 06FFFFh
	51	32K-WORD	160000h - 167FFFh		19	32K-WORD	060000h - 067FFFh
	50	32K-WORD	158000h - 15FFFFh		18	32K-WORD	058000h - 05FFFFh
	49	32K-WORD	150000h - 157FFFh		17	32K-WORD	050000h - 057FFFh
	48	32K-WORD	148000h - 14FFFFh		16	32K-WORD	048000h - 04FFFFh
	47	32K-WORD	140000h - 147FFFh		15	32K-WORD	040000h - 047FFFh
	46	32K-WORD	138000h - 13FFFFh		14	32K-WORD	038000h - 037FFFh
	45	32K-WORD	130000h - 137FFFh		13	32K-WORD	030000h - 037FFFh
	44	32K-WORD	128000h - 12FFFFh		12	32K-WORD	028000h - 02FFFFh
	43	32K-WORD	120000h - 127FFFh		11	32K-WORD	020000h - 027FFFh
42	32K-WORD	118000h - 11FFFFh	10		32K-WORD	018000h - 017FFFh	
41	32K-WORD	110000h - 117FFFh	9		32K-WORD	010000h - 017FFFh	
40	32K-WORD	108000h - 10FFFFh	8	32K-WORD	008000h - 00FFFFh		
39	32K-WORD	100000h - 107FFFh	7	4K-WORD	007000h - 007FFFh		
			6	4K-WORD	006000h - 006FFFh		
			5	4K-WORD	005000h - 005FFFh		
			4	4K-WORD	004000h - 004FFFh		
			3	4K-WORD	003000h - 003FFFh		
			2	4K-WORD	002000h - 002FFFh		
			1	4K-WORD	001000h - 001FFFh		
			0	4K-WORD	000000h - 000FFFh		

8. Absolute Maximum Ratings

Symbol	Parameter	Notes	Ratings	Unit
V_{CC}	Supply voltage	1,2	-0.2 to +3.9	V
V_{IN}	Input voltage	1,2,3,4	-0.2 to $V_{CC} + 0.3$	V
T_A	Operating temperature		-25 to +85	°C
T_{STG}	Storage temperature		-55 to +125	°C
F- V_{PP}	F- V_{PP} voltage	1,3,5	-0.2 to +12.6	V

Notes:

1. The maximum applicable voltage on any pins with respect to GND.
2. Except F- V_{PP} .
3. -2.0V undershoot and $V_{CC} + 2.0V$ overshoot are allowed when the pulse width is less than 20 nsec.
4. V_{IN} should not be over $V_{CC} + 0.3V$.
5. Applying 12V $\pm 0.3V$ to F- V_{PP} during erase/write can only be done for a maximum of 1000 cycles on each block. F- V_{PP} may be connected to 12V $\pm 0.3V$ for total of 80 hours maximum. +12.6V overshoot is allowed when the pulse width is less than 20 nsec.

9. Recommended DC Operating Conditions

($T_A = -25^\circ C$ to $+85^\circ C$)

Symbol	Parameter	Notes	Min.	Typ.	Max.	Unit
V_{CC}	Supply Voltage	2	2.7	3.0	3.3	V
V_{PP}	F- V_{PP} Voltage		1.65	3.0	3.3	V
V_{IH}	Input Voltage	1	2.2		$V_{CC} + 0.2$	V
V_{IL}	Input Voltage		-0.2		0.6	V

Notes:

1. V_{CC} is the lower of F- V_{CC} or S- V_{CC} .
2. V_{CC} includes both F- V_{CC} and S- V_{CC} .

10. Pin Capacitance⁽¹⁾

($T_A = 25^\circ C$, $f = 1MHz$)

Symbol	Parameter	Notes	Min.	Typ.	Max.	Unit	Condition
C_{IN}	Input capacitance				15	pF	$V_{IN} = 0V$
$C_{I/O}$	I/O capacitance				25	pF	$V_{I/O} = 0V$

Note:

1. Sampled but not 100% tested.

11. DC Electrical Characteristics⁽¹⁾

DC Electrical Characteristics

(T_A = -25°C to +85°C, V_{CC} = 2.7V to 3.3V)

Symbol	Parameter	Notes	Min.	Typ.	Max.	Unit	Test Conditions
I _{LI}	Input Leakage Current				±2	μA	V _{IN} = V _{CC} or GND
I _{LO}	Output Leakage Current				±2	μA	V _{OUT} = V _{CC} or GND
I _{CCS}	F-V _{CC} Standby Current	2		4	20	μA	F-V _{CC} = F-V _{CC} Max., F- $\overline{\text{CE}}$ = F-RST = F-V _{CC} ±0.2V, F- $\overline{\text{WP}}$ = F-V _{CC} or GND
I _{CCAS}	F-V _{CC} Automatic Power Savings Current	2,5		4	20	μA	F-V _{CC} = F-V _{CC} Max., F- $\overline{\text{CE}}$ = GND ±0.2V, F- $\overline{\text{WP}}$ = F-V _{CC} or GND
I _{CCD}	F-V _{CC} Reset Power-Down Current	2		4	20	μA	F-RST = GND ±0.2V I _{OUT} (F-RY/B $\overline{\text{Y}}$) = 0mA
I _{CCR}	Average F-V _{CC} Read Current Normal Mode	2,8		15	25	mA	F-V _{CC} = F-V _{CC} Max., F- $\overline{\text{CE}}$ = V _{IL} , F- $\overline{\text{OE}}$ = V _{IH} , f = 5MHz I _{OUT} = 0mA
	Average F-V _{CC} Read Current Page Mode	2,8		5	10	mA	
I _{CCW}	F-V _{CC} (Page Buffer) Program Current	2,6,8		20	60	mA	F-V _{PP} = V _{PPH1}
		2,6,8		10	20	mA	F-V _{PP} = V _{PPH2}
I _{CCE}	F-V _{CC} Block Erase, Full Chip Erase Current	2,6,8		10	30	mA	F-V _{PP} = V _{PPH1}
		2,6,8		10	30	mA	F-V _{PP} = V _{PPH2}
I _{CCWS} I _{CCES}	F-V _{CC} (Page Buffer) Program or Block Erase Suspend Current	2,3,8		10	200	μA	F- $\overline{\text{CE}}$ = V _{IH}
I _{PPS} I _{PPR}	F-V _{PP} Standby or Read Current	2,7,8		2	5	μA	F-V _{PP} ≤ F-V _{CC}
I _{PPW}	F-V _{PP} (Page Buffer) Program Current	2,6,7,8		2	5	μA	F-V _{PP} = V _{PPH1}
		2,6,7,8		10	30	mA	F-V _{PP} = V _{PPH2}
I _{PPE}	F-V _{PP} Block Erase, Full Chip Erase Current	2,6,7,8		2	5	μA	F-V _{PP} = V _{PPH1}
		2,6,7,8		5	15	mA	F-V _{PP} = V _{PPH2}
I _{PPWS}	F-V _{PP} (Page Buffer) Program Suspend Current	2,7,8		2	5	μA	F-V _{PP} = V _{PPH1}
		2,7,8		10	200	μA	F-V _{PP} = V _{PPH2}
I _{PPES}	F-V _{PP} Block Erase Suspend Current	2,7,8		2	5	μA	F-V _{PP} = V _{PPH1}
		2,7,8		10	200	μA	F-V _{PP} = V _{PPH2}

DC Electrical Characteristics (Continue)

($T_A = -25^{\circ}\text{C}$ to $+85^{\circ}\text{C}$, $V_{CC} = 2.7\text{V}$ to 3.3V)

Symbol	Parameter	Notes	Min.	Typ.	Max.	Unit	Conditions	
I_{SB}	S- V_{CC} Standby Current			2	25	μA	$S-\overline{CE}_1, S-CE_2 \geq S-V_{CC} - 0.2\text{V}$ or $S-CE_2 \leq 0.2\text{V}$	
I_{SB1}	S- V_{CC} Standby Current				3	mA	$S-\overline{CE}_1 = V_{IH}, S-CE_2 = V_{IL}$	
I_{CC1}	S- V_{CC} Operation Current				50	mA	$S-\overline{CE}_1 = V_{IL}, S-CE_2 = V_{IH}, V_{IN} = V_{IL}$ or V_{IH}	$t_{CYCLE} = \text{Min.}$ $I_{I/O} = 0\text{mA}$
I_{CC2}	S- V_{CC} Operation Current				8	mA	$S-\overline{CE}_1 \leq 0.2\text{V}, S-CE_2 \geq S-V_{CC} - 0.2\text{V}, V_{IN} \geq S-V_{CC} - 0.2\text{V}$ or $\leq 0.2\text{V}$	$t_{CYCLE} = 1\mu\text{s}$ $I_{I/O} = 0\text{mA}$
V_{IL}	Input Low Voltage	6	-0.2		0.6	V		
V_{IH}	Input High Voltage	6	2.2		$V_{CC} + 0.2$	V		
V_{OL}	Output Low Voltage	6			0.4	V	$I_{OL} = 0.5\text{mA}$	
V_{OH}	Output High Voltage	6	2.4			V	$I_{OH} = -0.5\text{mA}$	
V_{PPLK}	F- V_{PP} Lockout during Normal Operations	4,6,7			0.4	V		
V_{PPH1}	F- V_{PP} during Block Erase, Full Chip Erase,(PageBuffer) Program	7	1.65	3	3.3	V		
V_{PPH2}	F- V_{PP} during Block Erase, (PageBuffer) Program	7	11.7	12	12.3	V		
V_{LKO}	F- V_{CC} Lockout Voltage		1.5			V		

Notes:

- V_{CC} includes both F- V_{CC} and S- V_{CC} .
- All currents are in RMS unless otherwise noted. Typical values are the reference values at $V_{CC} = 3.0\text{V}$ and $T_A = +25^{\circ}\text{C}$ unless V_{CC} is specified.
- I_{CCWS} and I_{CCES} are specified with the device de-selected. If read or (page buffer) program while in block erase suspend mode, the device's current draw is the sum of I_{CCWS} or I_{CCES} and I_{CCR} or I_{CCW} , respectively.
- Block erase, full chip erase, (page buffer) program are inhibited when $F-V_{PP} \leq V_{PPLK}$, and not guaranteed in the range between V_{PPLK} (max.) and V_{PPH1} (min.), between V_{PPH1} (max.) and V_{PPH2} (min.) and above V_{PPH2} (max.).
- The Automatic Power Savings (APS) feature automatically places the device in power save mode after read cycle completion. Standard address access timings (t_{AVQV}) provide new data when addresses are changed.
- Sampled, not 100% tested.
- F- V_{PP} is not used for power supply pin. With $F-V_{PP} \leq V_{PPLK}$, block erase, full chip erase, (page buffer) program cannot be executed and should not be attempted.
Applying $12\text{V} \pm 0.3\text{V}$ to F- V_{PP} provides fast erasing or fast programming mode. In this mode, F- V_{PP} is power supply pin and supplies the memory cell current for block erasing and (page buffer) programming. Use similar power supply trace widths and layout considerations given to the V_{CC} power bus.
Applying $12\text{V} \pm 0.3\text{V}$ to F- V_{PP} during erase/program can only be done for a maximum of 1000 cycles on each block. F- V_{PP} may be connected to $12\text{V} \pm 0.3\text{V}$ for a total of 80 hours maximum.
- The operating current in dual work is the sum of the operating current (read, erase, program) in each plane.

12. AC Electrical Characteristics for Flash Memory

12.1 AC Test Conditions

Input pulse level	0 V to 2.7 V
Input rise and fall time	5 ns
Input and Output timing Ref. level	1.35 V
Output load	1TTL + C _L (50pF)

12.2 Read Cycle

(T_A = -25°C to +85°C, F-V_{CC} = 2.7V to 3.3V)

Symbol	Parameter	Notes	Min.	Max.	Unit
t _{AVAV}	Read Cycle Time		85		ns
t _{AVQV}	Address to Output Delay			85	ns
t _{ELQV}	F- $\overline{\text{CE}}$ to Output Delay	2		85	ns
t _{APA}	Page Address Access Time			30	ns
t _{GLQV}	F- $\overline{\text{OE}}$ to Output Delay	2		20	ns
t _{PHQV}	F- $\overline{\text{RST}}$ High to Output Delay			150	ns
t _{EHQZ} , t _{GHQZ}	F- $\overline{\text{CE}}$ or F- $\overline{\text{OE}}$ to Output in High - Z, Whichever Occurs First	1		20	ns
t _{ELQX}	F- $\overline{\text{CE}}$ to Output in Low - Z	1	0		ns
t _{GLQX}	F- $\overline{\text{OE}}$ to Output in Low - Z	1	0		ns
t _{OH}	Output Hold from First Occurring Address, F- $\overline{\text{CE}}$ or F- $\overline{\text{OE}}$ change	1	0		ns

Notes:

1. Sampled, not 100% tested.
2. F- $\overline{\text{OE}}$ may be delayed up to t_{ELQV} - t_{GLQV} after the falling edge of F- $\overline{\text{CE}}$ without impact to t_{ELQV}.

12.3 Write Cycle (F- \overline{WE} / F- \overline{CE} Controlled)^(1,2)

(T_A = -25°C to +85°C, F-V_{CC} = 2.7V to 3.3V)

Symbol	Parameter	Notes	Min.	Max.	Unit
t _{AVAV}	Write Cycle Time		85		ns
t _{PHWL} (t _{PHL})	F- \overline{RST} High Recovery to F- \overline{WE} (F- \overline{CE}) Going Low	3	150		ns
t _{ELWL} (t _{WLEL})	F- \overline{CE} (F- \overline{WE}) Setup to F- \overline{WE} (F- \overline{CE}) Going Low	4	0		ns
t _{WLWH} (t _{ELEH})	F- \overline{WE} (F- \overline{CE}) Pulse Width	4	60		ns
t _{DVWH} (t _{DVEH})	Data Setup to F- \overline{WE} (F- \overline{CE}) Going High	8	40		ns
t _{AVWH} (t _{AVEH})	Address Setup to F- \overline{WE} (F- \overline{CE}) Going High	8	50		ns
t _{WHEH} (t _{EHWH})	F- \overline{CE} (F- \overline{WE}) Hold from F- \overline{WE} (F- \overline{CE}) High		0		ns
t _{WHDH} (t _{EHDH})	Data Hold from F- \overline{WE} (F- \overline{CE}) High		0		ns
t _{WHAX} (t _{EHAX})	Address Hold from F- \overline{WE} (F- \overline{CE}) High		0		ns
t _{WHWL} (t _{EHEL})	F- \overline{WE} (F- \overline{CE}) Pulse Width High	5	30		ns
t _{SHWH} (t _{SHEH})	F- \overline{WP} High Setup to F- \overline{WE} (F- \overline{CE}) Going High	3	0		ns
t _{VVWH} (t _{VVEH})	F-V _{pp} Setup to F- \overline{WE} (F- \overline{CE}) Going High	3	200		ns
t _{WHGL} (t _{EHGL})	Write Recovery before Read		30		ns
t _{QVSL}	F- \overline{WP} High Hold from Valid SRD, F-RY/ \overline{BY} High-Z	3, 6	0		ns
t _{QVVL}	F-V _{pp} Hold from Valid SRD, F-RY/ \overline{BY} High-Z	3, 6	0		ns
t _{WHR0} (t _{EHR0})	F- \overline{WE} (F- \overline{CE}) High to SR.7 Going "0"	3, 7		t _{AVQV} +40	ns
t _{WHRL} (t _{EHRL})	F- \overline{WE} (F- \overline{CE}) High to F-RY/ \overline{BY} Going Low	3		100	ns

Notes:

1. The timing characteristics for reading the status register during block erase, full chip erase, (page buffer) program operations are the same as during read-only operations. See the AC Characteristics for read cycle.
2. A write operation can be initiated and terminated with either F- \overline{CE} or F- \overline{WE} .
3. Sampled, not 100% tested.
4. Write pulse width (t_{WP}) is defined from the falling edge of F- \overline{CE} or F- \overline{WE} (whichever goes low last) to the rising edge of F- \overline{CE} or F- \overline{WE} (whichever goes high first). Hence, t_{WP}=t_{WLWH}=t_{ELEH}=t_{WLEH}=t_{ELWH}.
5. Write pulse width high (t_{WPH}) is defined from the rising edge of F- \overline{CE} or F- \overline{WE} (whichever goes high first) to the falling edge of F- \overline{CE} or F- \overline{WE} (whichever goes low last). Hence, t_{WPH}=t_{WHWL}=t_{EHEL}=t_{WHEL}=t_{EHWL}.
6. F-V_{pp} should be held at F-V_{pp}=V_{ppH1/2} until determination of block erase, (page buffer) program success (SR.1/3/4/5=0) and held at F-V_{pp}=V_{ppH1} until determination of full chip erase success (SR.1/3/5=0).
7. t_{WHR0} (t_{EHR0}) after the Read Query or Read Identifier Codes command=t_{AVQV}+100ns.
8. See 5.1 Command Definitions for valid address and data for block erase, full chip erase, (page buffer) program or lock bit configuration.

12.4 Block Erase, Full Chip Erase, (Page Buffer) Program Performance⁽³⁾

(T_A = -25°C to +85°C, F-V_{CC} = 2.7V to 3.3V)

Symbol	Parameter	Notes	Page Buffer Command is Used or not Used	F-V _{pp} =V _{ppH1} (In System)			F-V _{pp} =V _{ppH2} (In Manufacturing)			Unit
				Min.	Typ. ⁽¹⁾	Max. ⁽²⁾	Min.	Typ. ⁽¹⁾	Max. ⁽²⁾	
t _{WPB}	4K-Word Parameter Block Program Time	2	Not Used		0.05	0.3		0.04	0.12	s
		2	Used		0.03	0.12		0.02	0.06	s
t _{WMB}	32K-Word Main Block Program Time	2	Not Used		0.38	2.4		0.31	1	s
		2	Used		0.24	1		0.17	0.5	s
t _{WHQV1} / t _{EHQV1}	Word Program Time	2	Not Used		11	200		9	185	μs
		2	Used		7	100		5	90	μs
t _{WHQV2} / t _{EHQV2}	4K-Word Parameter Block Erase Time	2	-		0.3	4		0.2	4	s
t _{WHQV3} / t _{EHQV3}	32K-Word Main Block Erase Time	2	-		0.6	5		0.5	5	s
	Full Chip Erase Time	2			40	350				s
t _{WHRH1} / t _{EHRH1}	(Page Buffer) Program Suspend Latency Time to Read	4	-		5	10		5	10	μs
t _{WHRH2} / t _{EHRH2}	Block Erase Suspend Latency Time to Read	4	-		5	20		5	20	μs
t _{ERES}	Latency Time from Block Erase Resume Command to Block Erase Suspend Command	5	-	500			500			μs

Notes:

1. Typical values measured at F-V_{CC} = 3.0V, F-V_{pp} = 3.0V or 12V, and T_A = +25°C. Assumes corresponding lock bits are not set. Subject to change based on device characterization.
2. Excludes external system-level overhead.
3. Sampled, but not 100% tested.
4. A latency time is required from writing suspend command (F- \overline{WE} or F- \overline{CE} going high) until SR.7 going "1" or F-RY/ \overline{BY} going High-Z.
5. If the interval time from a Block Erase Resume command to a subsequent Block Erase Suspend command is shorter than t_{ERES} and its sequence is repeated, the block erase operation may not be finished.

12.5 Flash Memory AC Characteristics Timing Chart

AC Waveform for Single Asynchronous Read Operations from Status Register, Identifier Codes or Query Code

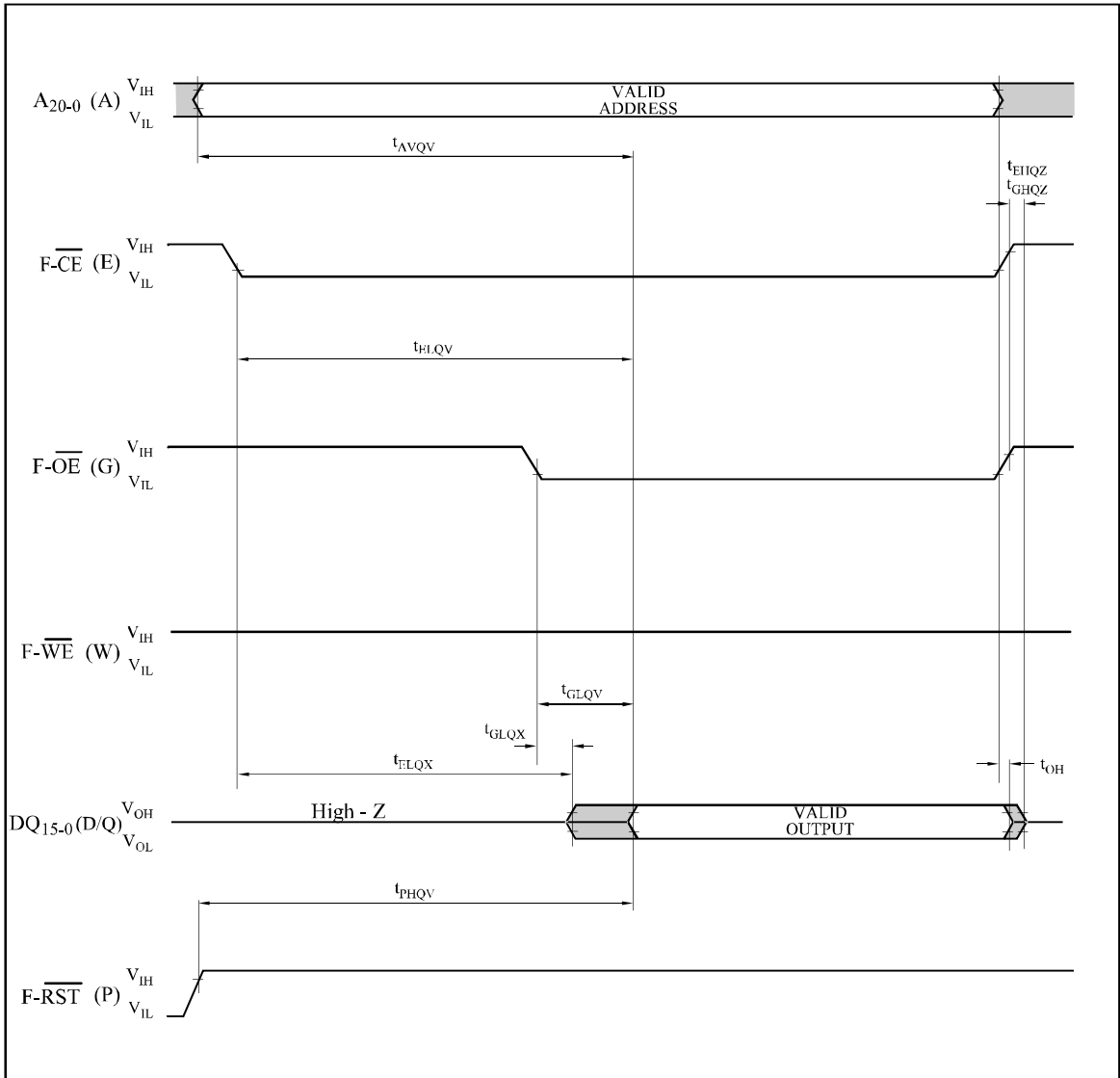

AC Waveform for Asynchronous Page Mode Read Operations from Main Blocks or Parameter Blocks

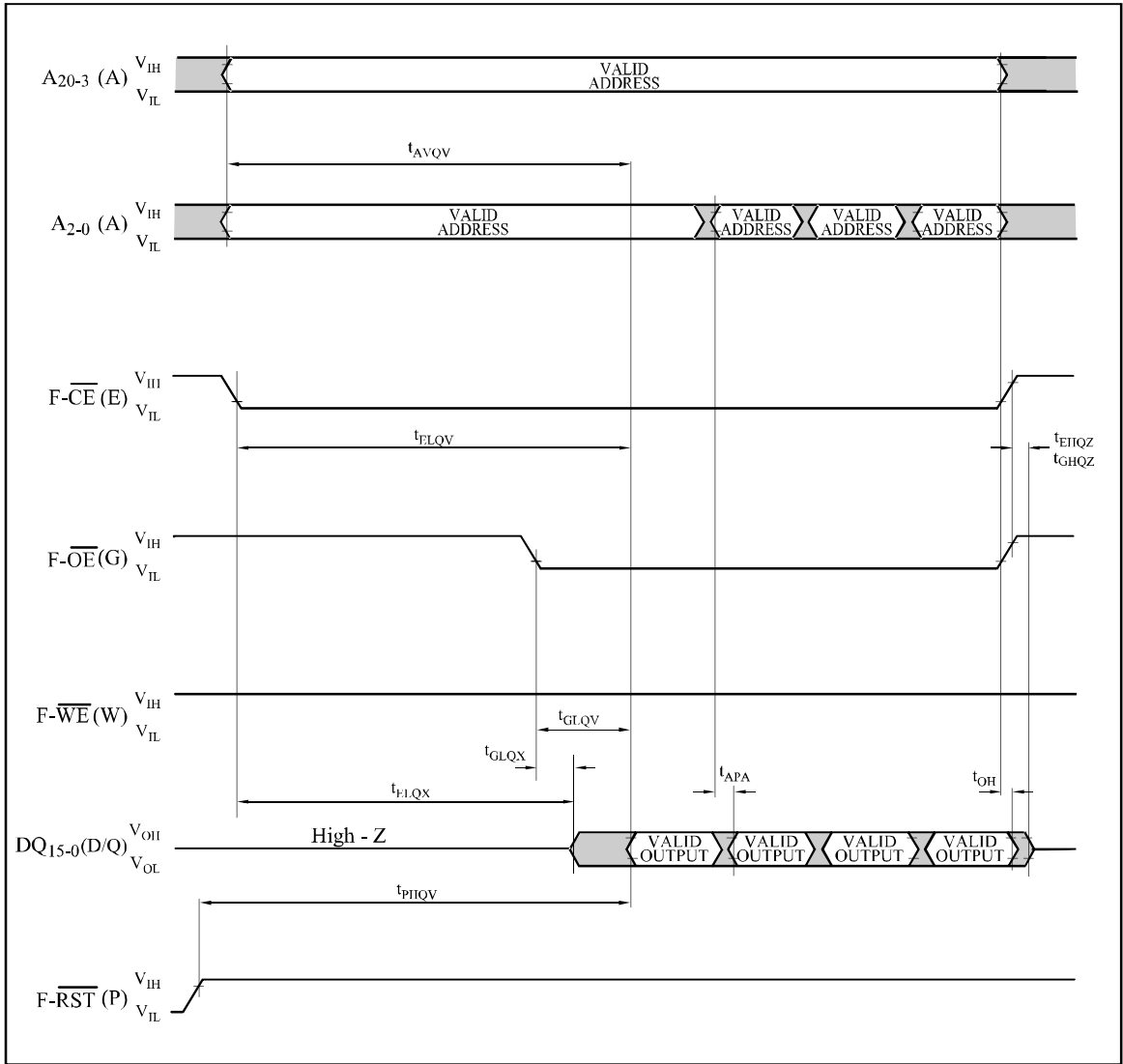

12.6 Reset Operations

($T_A = -25^{\circ}\text{C}$ to $+85^{\circ}\text{C}$, $F\text{-}V_{CC} = 2.7\text{V}$ to 3.3V)

Symbol	Parameter	Notes	Min.	Max.	Unit
t_{PLPH}	F- $\overline{\text{RST}}$ Low to Reset during Read (F- $\overline{\text{RST}}$ should be low during power-up.)	1, 2, 3	100		ns
t_{PLRH}	F- $\overline{\text{RST}}$ Low to Reset during Erase or Program	1, 3, 4		22	μs
t_{VPH}	F- V_{CC} 2.7V to F- $\overline{\text{RST}}$ High	1, 3, 5	100		ns
t_{VHQP}	F- V_{CC} 2.7V to Output Delay	3		1	ms

Notes:

1. A reset time, t_{PHQV} , is required from the later of SR.7 (F-RY/ $\overline{\text{BY}}$) going "1" (High-Z) or F- $\overline{\text{RST}}$ going high until outputs are valid. See the AC Characteristics - read cycle for t_{PHQV} .
2. t_{PLPH} is <100ns the device may still reset but this is not guaranteed.
3. Sampled, not 100% tested.
4. If F- $\overline{\text{RST}}$ asserted while a block erase, full chip erase or (page buffer) program operation is not executing, the reset will complete within 100ns.
5. When the device power-up, holding F- $\overline{\text{RST}}$ low minimum 100ns is required after F- V_{CC} has been in predefined range and also has been in stable there.

AC Waveform for Reset Operation

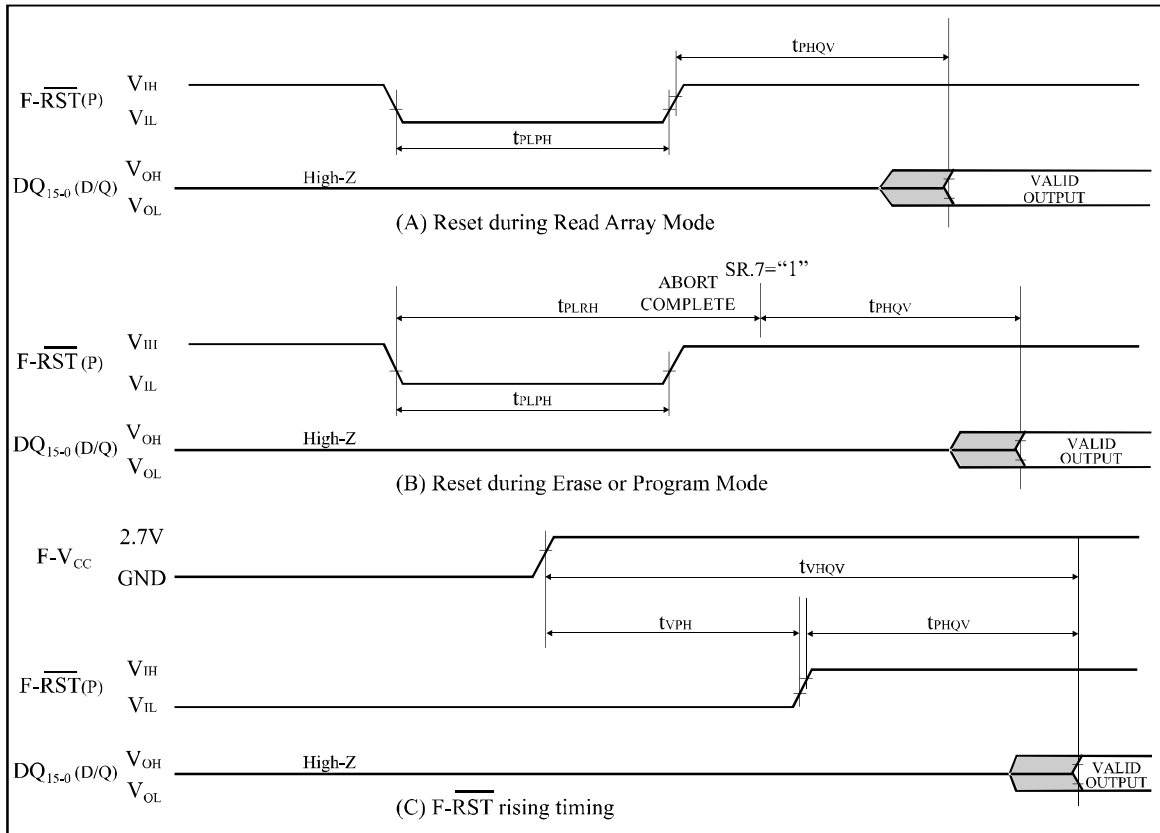

13. AC Electrical Characteristics for SRAM

13.1 AC Test Conditions

Input pulse level	0.4 V to 2.2 V
Input rise and fall time	5 ns
Input and Output timing Ref. level	1.5 V
Output load	1TTL + C _L (30pF) ⁽¹⁾

Note:

1. Including scope and socket capacitance.

13.2 Read Cycle

(T_A = -25°C to +85°C, S-V_{CC} = 2.7V to 3.3V)

Symbol	Parameter	Notes	Min.	Max.	Unit
t _{RC}	Read Cycle Time		70		ns
t _{AA}	Address Access Time			70	ns
t _{ACE1}	Chip Enable Access Time (S- \overline{CE}_1)			70	ns
t _{ACE2}	Chip Enable Access Time (S-CE ₂)			70	ns
t _{BE}	Byte Enable Access Time			70	ns
t _{OE}	Output Enable to Output Valid			40	ns
t _{OH}	Output Hold from Address Change		10		ns
t _{LZ1}	S- \overline{CE}_1 Low to Output Active	1	10		ns
t _{LZ2}	S-CE ₂ High to Output Active	1	10		ns
t _{OLZ}	S- \overline{OE} Low to Output Active	1	5		ns
t _{BLZ}	S- \overline{UB} or S- \overline{LB} Low to Output Active	1	5		ns
t _{HZ1}	S- \overline{CE}_1 High to Output in High-Z	1	0	25	ns
t _{HZ2}	S-CE ₂ Low to Output in High-Z	1	0	25	ns
t _{OHZ}	S- \overline{OE} High to Output in High-Z	1	0	25	ns
t _{BHZ}	S- \overline{UB} or S- \overline{LB} High to Output in High-Z	1	0	25	ns

Note:

1. Active output to High-Z and High-Z to output active tests specified for a ± 200 mV transition from steady state levels into the test load.

13.3 Write Cycle

(T_A = -25°C to +85°C, S-V_{CC} = 2.7V to 3.3V)

Symbol	Parameter	Notes	Min.	Max.	Unit
t _{WC}	Write Cycle Time		70		ns
t _{CW}	Chip Enable to End of Write		60		ns
t _{AW}	Address Valid to End of Write		60		ns
t _{BW}	Byte Select Time		60		ns
t _{AS}	Address Setup Time		0		ns
t _{WP}	Write Pulse Width		50		ns
t _{WR}	Write Recovery Time		0		ns
t _{DW}	Input Data Setup Time		30		ns
t _{DH}	Input Data Hold Time		0		ns
t _{OW}	S- $\overline{\text{WE}}$ High to Output Active	1	5		ns
t _{WZ}	S- $\overline{\text{WE}}$ Low to Output in High-Z	1	0	25	ns

Note:

- Active output to High-Z and High-Z to output active tests specified for a $\pm 200\text{mV}$ transition from steady state levels into the test load.

13.4 SRAM AC Characteristics Timing Chart

Read Cycle Timing Chart

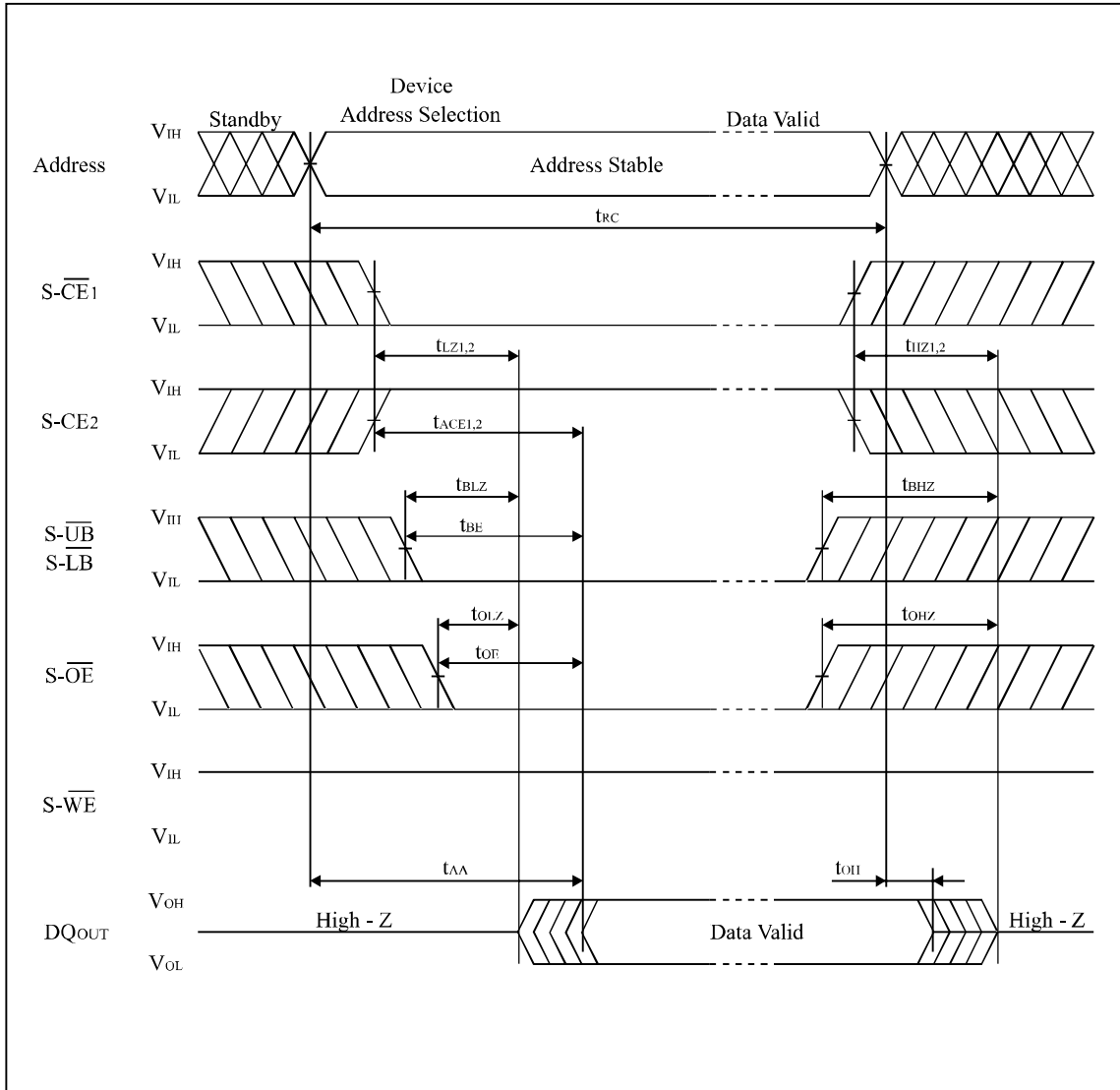

Write Cycle Timing Chart (S-WE Controlled)

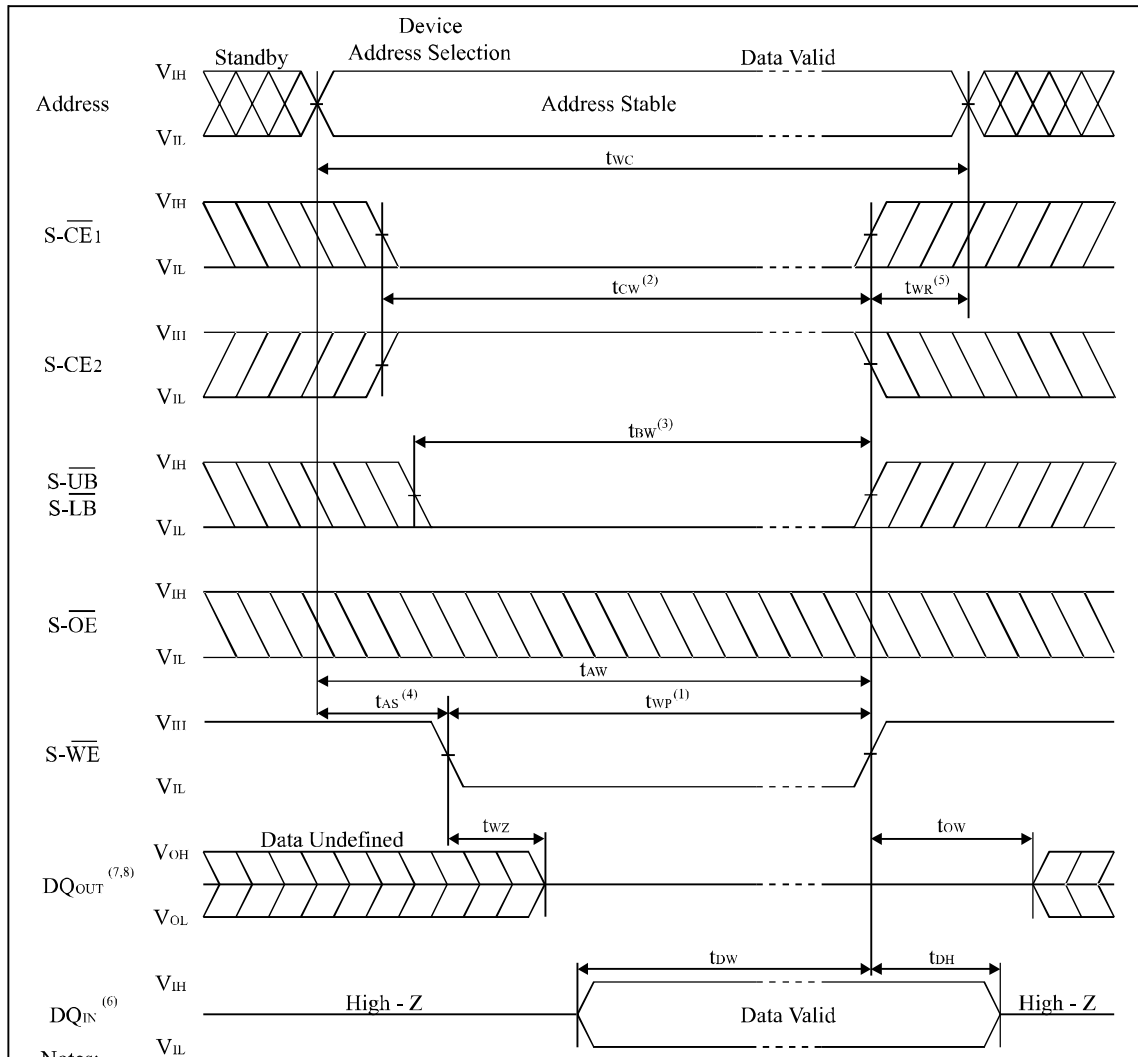

Notes:

1. A write occurs during the overlap of a low S-CE₁, a high S-CE₂ and a low S-WE.
 A write begins at the latest transition among S-CE₁ going low, S-CE₂ going high and S-WE going low.
 A write ends at the earliest transition among S-CE₁ going high, S-CE₂ going low and S-WE going high.
 t_{WP} is measured from the beginning of write to the end of write.
2. t_{CW} is measured from the later of S-CE₁ going low or S-CE₂ going high to the end of write.
3. t_{BW} is measured from the time of going low S-UB or low S-LB to the end of write.
4. t_{AS} is measured from the address valid to beginning of write.
5. t_{WR} is measured from the end of write to the address change. t_{WR} applies in case a write ends at S-CE₁ going high, S-CE₂ going low or S-WE going high.
6. During this period DQ pins are in the output state, therefore the input signals of opposite phase to the outputs must not be applied.
7. If S-CE₁ goes low or S-CE₂ goes high simultaneously with S-WE going low or after S-WE going low, the outputs remain in high impedance state.
8. If S-CE₁ goes high or S-CE₂ goes low simultaneously with S-WE going high or before S-WE going high, the outputs remain in high impedance state.

Write Cycle Timing Chart (S-CE Controlled)

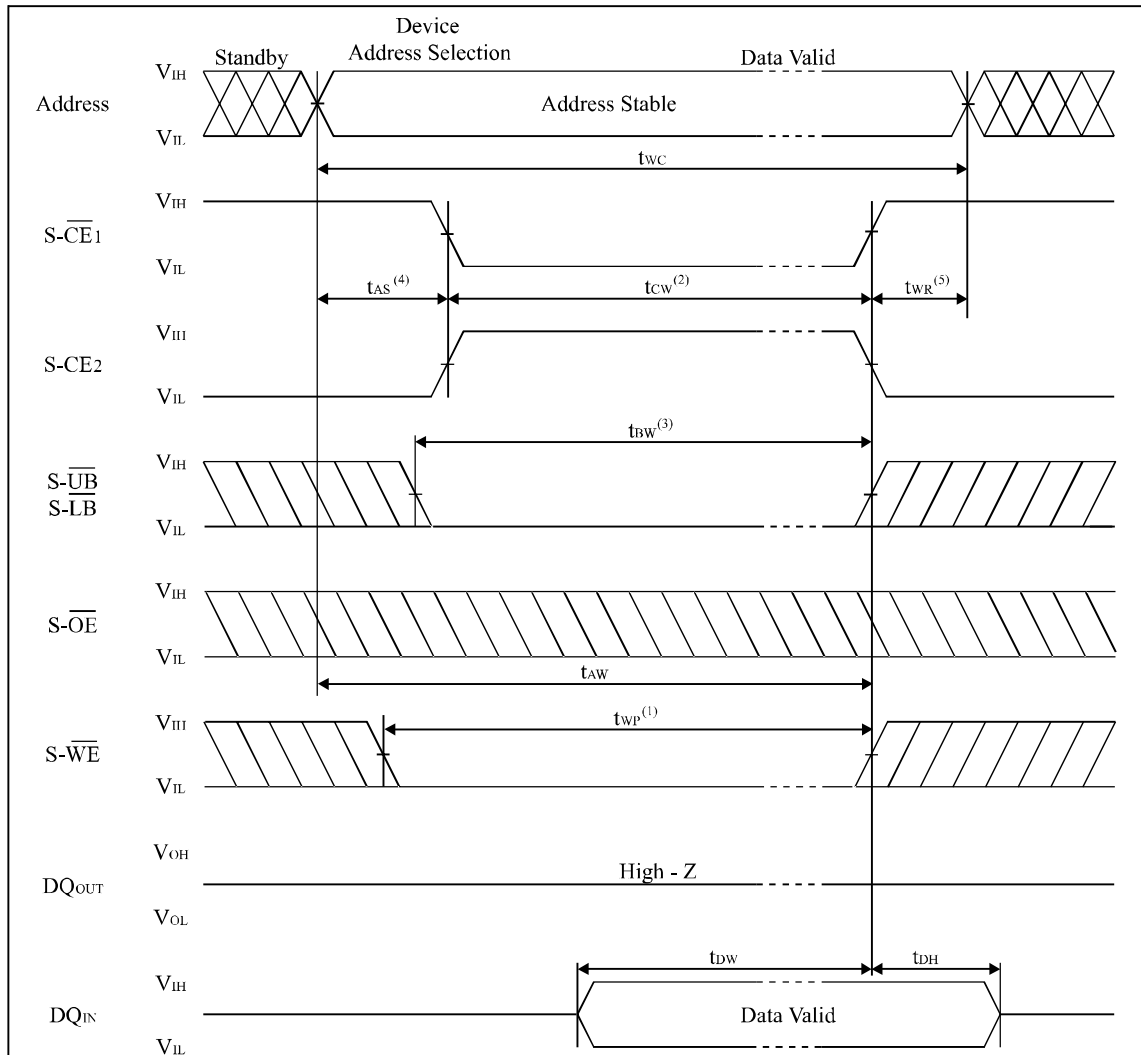

Notes:

1. A write occurs during the overlap of a low S-CE₁, a high S-CE₂ and a low S-WE.
 A write begins at the latest transition among S-CE₁ going low, S-CE₂ going high and S-WE going low.
 A write ends at the earliest transition among S-CE₁ going high, S-CE₂ going low and S-WE going high.
 t_{WP} is measured from the beginning of write to the end of write.
2. t_{CW} is measured from the later of S-CE₁ going low or S-CE₂ going high to the end of write.
3. t_{BW} is measured from the time of going low S-UB or low S-LB to the end of write.
4. t_{AS} is measured from the address valid to beginning of write.
5. t_{WR} is measured from the end of write to the address change. t_{WR} applies in case a write ends at S-CE₁ going high, S-CE₂ going low or S-WE going high.

Write Cycle Timing Chart (S-UB, S-LB Controlled)

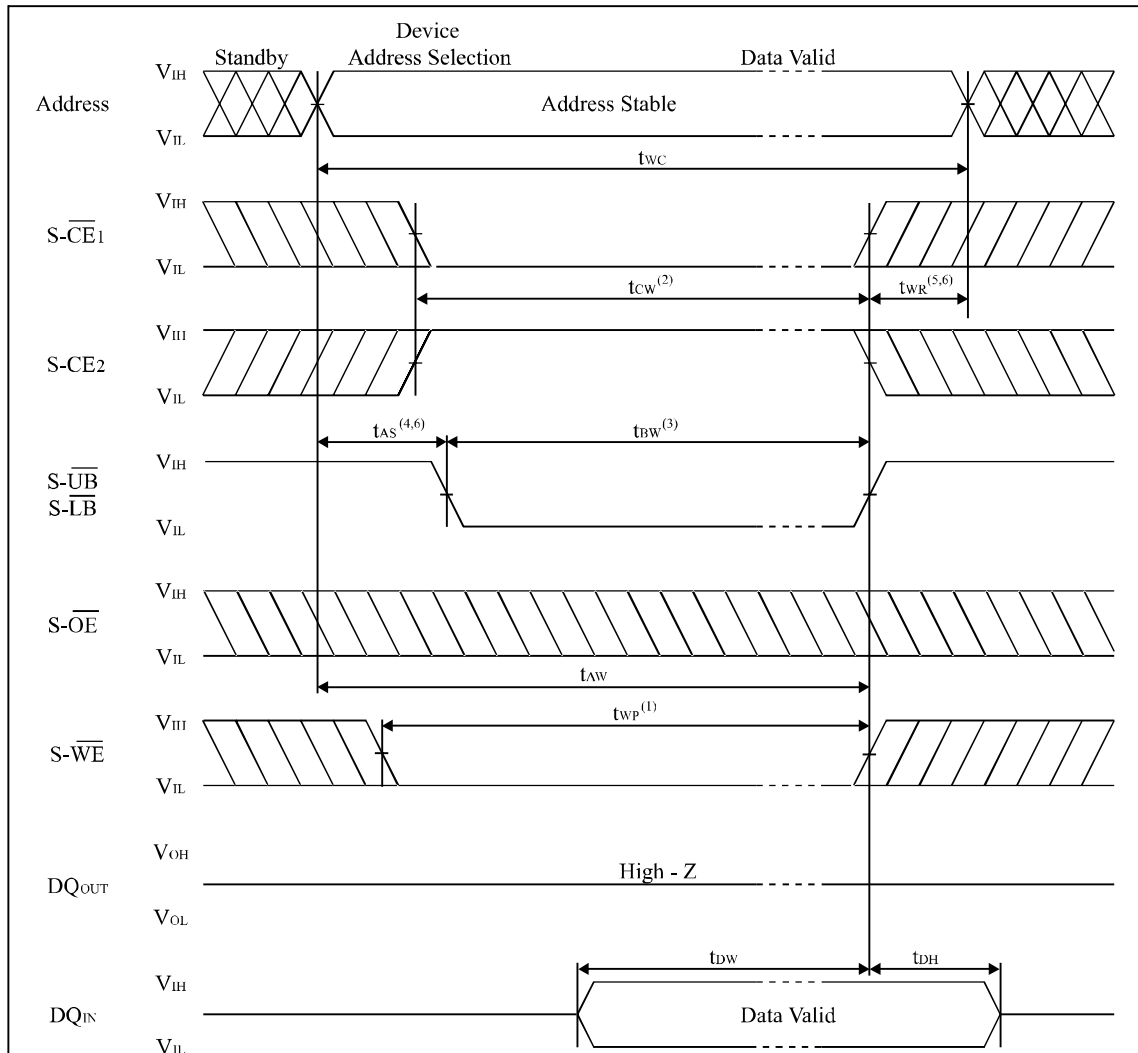

Notes:

1. A write occurs during the overlap of a low S-CE₁, a high S-CE₂ and a low S-WE.
 A write begins at the latest transition among S-CE₁ going low, S-CE₂ going high and S-WE going low.
 A write ends at the earliest transition among S-CE₁ going high, S-CE₂ going low and S-WE going high.
 t_{wp} is measured from the beginning of write to the end of write.
2. t_{cw} is measured from the later of S-CE₁ going low or S-CE₂ going high to the end of write.
3. t_{bw} is measured from the time of going low S-UB or low S-LB to the end of write.
4. t_{as} is measured from the address valid to beginning of write.
5. t_{wr} is measured from the end of write to the address change. t_{wr} applies in case a write ends at S-CE₁ going high, S-CE₂ going low or S-WE going high.
6. S-UB and S-LB need to make the time of start of a cycle, and an end "high" level for reservation of t_{as} and t_{wr} .

14. Data Retention Characteristics for SRAM

($T_A = -25^{\circ}\text{C}$ to $+85^{\circ}\text{C}$)

Symbol	Parameter	Note	Min.	Typ. ⁽¹⁾	Max.	Unit	Conditions
V_{CCDR}	Data Retention Supply voltage	2	1.5		3.3	V	$S\text{-CE}_2 \leq 0.2\text{V}$ or $S\text{-}\overline{\text{CE}}_1 \geq S\text{-}V_{CC} - 0.2\text{V}$
I_{CCDR}	Data Retention Supply current	2		2	25	μA	$S\text{-}V_{CC} = 3.0\text{V}$, $S\text{-CE}_2 \leq 0.2\text{V}$ or $S\text{-}\overline{\text{CE}}_1 \geq S\text{-}V_{CC} - 0.2\text{V}$
t_{CDR}	Chip enable setup time		0			ns	
t_R	Chip enable hold time		t_{RC}			ns	

Notes

- Reference value at $T_A = 25^{\circ}\text{C}$, $S\text{-}V_{CC} = 3.0\text{V}$.
- $S\text{-}\overline{\text{CE}}_1 \geq S\text{-}V_{CC} - 0.2\text{V}$, $S\text{-CE}_2 \geq S\text{-}V_{CC} - 0.2\text{V}$ ($S\text{-}\overline{\text{CE}}_1$ controlled) or $S\text{-CE}_2 \leq 0.2\text{V}$ ($S\text{-CE}_2$ controlled).

Data Retention timing chart ($S\text{-}\overline{\text{CE}}_1$ Controlled)⁽¹⁾

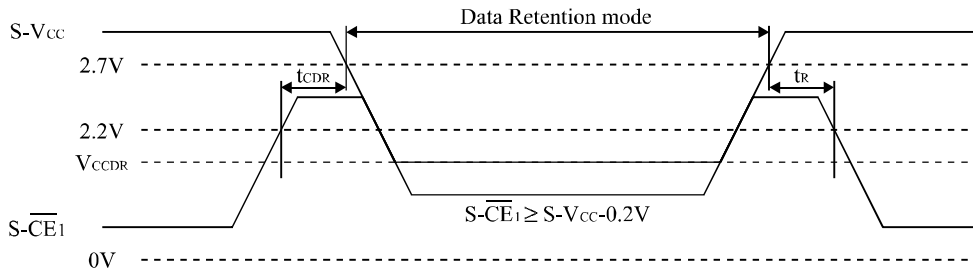

Note:

- To control the data retention mode at $S\text{-}\overline{\text{CE}}_1$, fix the input level of $S\text{-CE}_2$ between " V_{CCDR} and $V_{CCDR}-0.2\text{V}$ " or " 0V and 0.2V " during the data retention mode.

Data Retention timing chart ($S\text{-CE}_2$ Controlled)

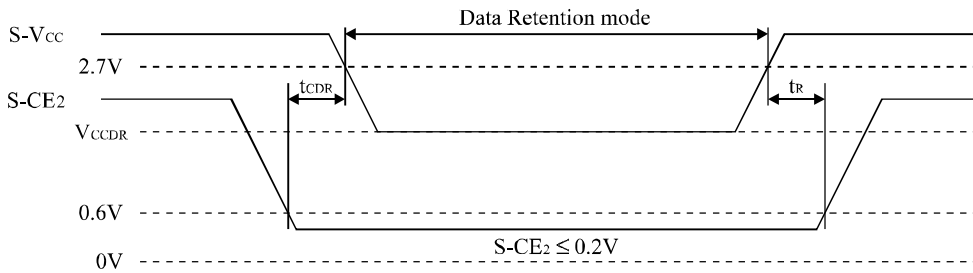

15. Notes

This product is a stacked CSP package that a 32M (x16) bit Flash Memory and a 8M (x16) bit SRAM are assembled into.

- Supply Power

Maximum difference (between $F-V_{CC}$ and $S-V_{CC}$) of the voltage is less than 0.3V.

- Power Supply and Chip Enable of Flash Memory and SRAM ($F-\overline{CE}$, $S-\overline{CE}_1$, $S-\overline{CE}_2$)

$S-\overline{CE}_1$ should not be "low" and $S-\overline{CE}_2$ should not be "high" when $F-\overline{CE}$ is "low" simultaneously.

If the two memories are active together, possibly they may not operate normally by interference noises or data collision on DQ bus.

Both $F-V_{CC}$ and $S-V_{CC}$ are needed to be applied by the recommended supply voltage at the same time expect SRAM data retention mode.

- Power Up Sequence

When turning on Flash memory power supply, keep $F-\overline{RST}$ "low". After $F-V_{CC}$ reaches over 2.7V, keep $F-\overline{RST}$ "low" for more than 100 nsec.

- Device Decoupling

The power supply is needed to be designed carefully because one of the SRAM and the Flash Memory is in standby mode when the other is active. A careful decoupling of power supplies is necessary between SRAM and Flash Memory. Note peak current caused by transition of control signals ($F-\overline{CE}$, $S-\overline{CE}_1$, $S-\overline{CE}_2$).

16. Flash Memory Data Protection

Noises having a level exceeding the limit specified in the specification may be generated under specific operating conditions on some systems. Such noises, when induced onto F- \overline{WE} signal or power supply, may be interpreted as false commands and causes undesired memory updating. To protect the data stored in the flash memory against unwanted writing, systems operating with the flash memory should have the following write protect designs, as appropriate:

■ The below describes data protection method.

1. Protection of data in each block

- Any locked block by setting its block lock bit is protected against the data alteration. When F- \overline{WP} is low, any locked-down block by setting its block lock-down bit is protected from lock status changes.
By using this function, areas can be defined, for example, program area (locked blocks), and data area (unlocked blocks).
- For detailed block locking scheme, see Chapter 5.Command Definitions for Flash Memory.

2. Protection of data with F- V_{PP} control

- When the level of F- V_{PP} is lower than V_{PPLK} (F- V_{PP} lockout voltage), write functions to all blocks are disabled. All blocks are locked and the data in the blocks are completely protected.

3. Protection of data with F- \overline{RST}

- Especially during power transitions such as power-up and power-down, the flash memory enters reset mode by bringing F- \overline{RST} to low, which inhibits write operation to all blocks.
- For detailed description on F- \overline{RST} control, see Chapter 12.6 AC Electrical Characteristics for Flash Memory, Reset Operations.

■ Protection against noises on F- \overline{WE} signal

To prevent the recognition of false commands as write commands, system designer should consider the method for reducing noises on F- \overline{WE} signal.

17. Design Considerations

1. Power Supply Decoupling

To avoid a bad effect to the system by flash memory power switching characteristics, each device should have a 0.1μF ceramic capacitor connected between its F-V_{CC} and GND and between its F-V_{PP} and GND.

Low inductance capacitors should be placed as close as possible to package leads.

2. F-V_{PP} Trace on Printed Circuit Boards

Updating the memory contents of flash memories that reside in the target system requires that the printed circuit board designer pay attention to the F-V_{PP} Power Supply trace. Use similar trace widths and layout considerations given to the F-V_{CC} power bus.

3. The Inhibition of Overwrite Operation

Please do not execute reprogramming “0” for the bit which has already been programmed “0”. Overwrite operation may generate unerasable bit.

In case of reprogramming “0” to the data which has been programmed “1”.

- Program “0” for the bit in which you want to change data from “1” to “0”.
- Program “1” for the bit which has already been programmed “0”.

For example, changing data from “101110110111101” to “1010110110111100” requires “111011111111110” programming.

4. Power Supply

Block erase, full chip erase, word write with an invalid F-V_{PP} (See Chapter 11. DC Electrical Characteristics) produce spurious results and should not be attempted.

Device operations at invalid F-V_{CC} voltage (See Chapter 11. DC Electrical Characteristics) produce spurious results and should not be attempted.

18. Related Document Information⁽¹⁾

Document No.	Document Name
FUM00701	LH28F320BF, LH28F640BF Series Appendix

Note:

1. International customers should contact their local SHARP or distribution sales offices.

19 Package and packing specification

1.Storage Conditions.

1-1.Storage conditions required before opening the dry packing.

- Normal temperature : 5~40°C
- Normal humidity : 80% R.H. max.

1-2.Storage conditions required after opening the dry packing.

In order to prevent moisture absorption after opening, ensure the following storage conditions apply:

- (1) Storage conditions for one-time soldering. (Convection reflow*1, IR/Convection reflow.*1)
 - Temperature : 5~25°C
 - Humidity : 60% R.H. max.
 - Period : 96 hours max. after opening.
- (2) Storage conditions for two-time soldering. (Convection reflow*1, IR/Convection reflow.*1)
 - a. Storage conditions following opening and prior to performing the 1st reflow.
 - Temperature : 5~25°C.
 - Humidity : 60% R.H. max.
 - Period : 96 hours max. after opening.
 - b. Storage conditions following completion of the 1st reflow and prior to performing the 2nd reflow.
 - Temperature : 5~25°C.
 - Humidity : 60% R.H. max.
 - Period : 96 hours max. after completion of the 1st reflow.

*1:Air or nitrogen environment.

1-3.Temporary storage after opening.

To re-store the devices before soldering, do so only once and use a dry box or place desiccant (with a blue humidity indicator) with the devices and perform dry packing again using heat-sealing.

The storage period, temperature and humidity must be as follows :

(1) Storage temperature and humidity.

※1 : External atmosphere temperature and humidity of the dry packing.

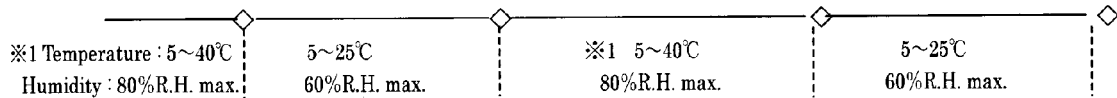
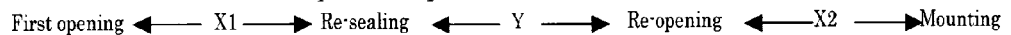

(2) Storage period.

- X1 + X2 : Refer to Section 1-2(1) and (2)a , depending on the mounting method.
- Y : Two weeks max.

2. Baking Condition.

- (1) Situations requiring baking before mounting.
 - Storage conditions exceed the limits specified in Section 1-2 or 1-3.
 - Humidity indicator in the desiccant was already red (pink) when opened.
(Also for re-opening.)
- (2) Recommended baking conditions.
 - Baking temperature and period :
120+10/-0°C for 1~3 hours.
 - The above baking conditions apply since the trays are heat-resistant.
- (3) Storage after baking.
 - After baking, store the devices in the environment specified in Section 1-2 and mount immediately.

3. Surface mount conditions.

The following soldering condition are recommended to ensure device quality.

3-1. Soldering.

- (1) Convection reflow or IR/Convection. (one-time soldering or two-time soldering in air or nitrogen environment)
 - Temperature and period :
Peak temperature of 240°C max., above 230°C for 15 sec. max.
Above 200°C for 30~50 sec.
Preheat temperature of 140~160°C for 90±30 sec.
Temperature increase rate of 1~3°C/sec.
 - Measuring point : IC package surface.
 - Temperature profile :

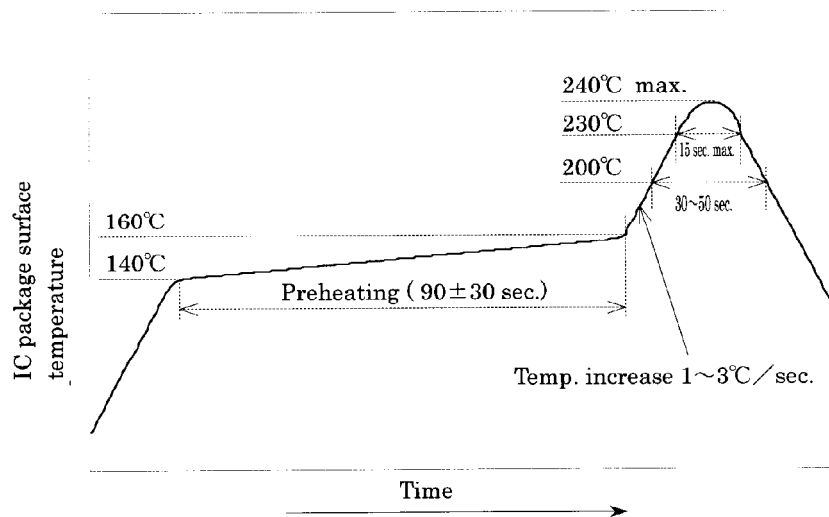

4. Condition for removal of residual flux.

- (1) Ultrasonic washing power : 25 watts / liter max.
- (2) Washing time : Total 1 minute max.
- (3) Solvent temperature : 15~40°C

5. Package outline specification.

Due to the different manufacturing process, there are tow types of package outline. (see *1)
 No changes are planned on package structure, substrate, and quality or reliability level
 remains unchanges. Refer to the attached drawing.

6. Markings.

6-1. Marking details. (The information on the package should be given as follows.)

- (1) Product name : LRS1383
- (2) Company name : S
- (3) Date code

(Example) YY WW XXX

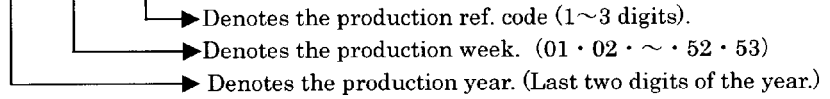

6-2. Marking layout.

The layout is shown in the attached drawing.

(However, this layout does not specify the size of the marking character and marking position.)

*1 Package outline

Item	Chamfered type	Rectangle type
Manufacturing Process	Devices are encapsulated separately, the cut into individual units by tool.	Multiple devices are encapsulated together, then cut into individual units by saw.
Drawing No.	AA2078	AA2149
Package outline		
Package index mark	Ejector pin mark.	Ink mark.
The word of "BATCH" is printed on the packing label	Not printed	Printed

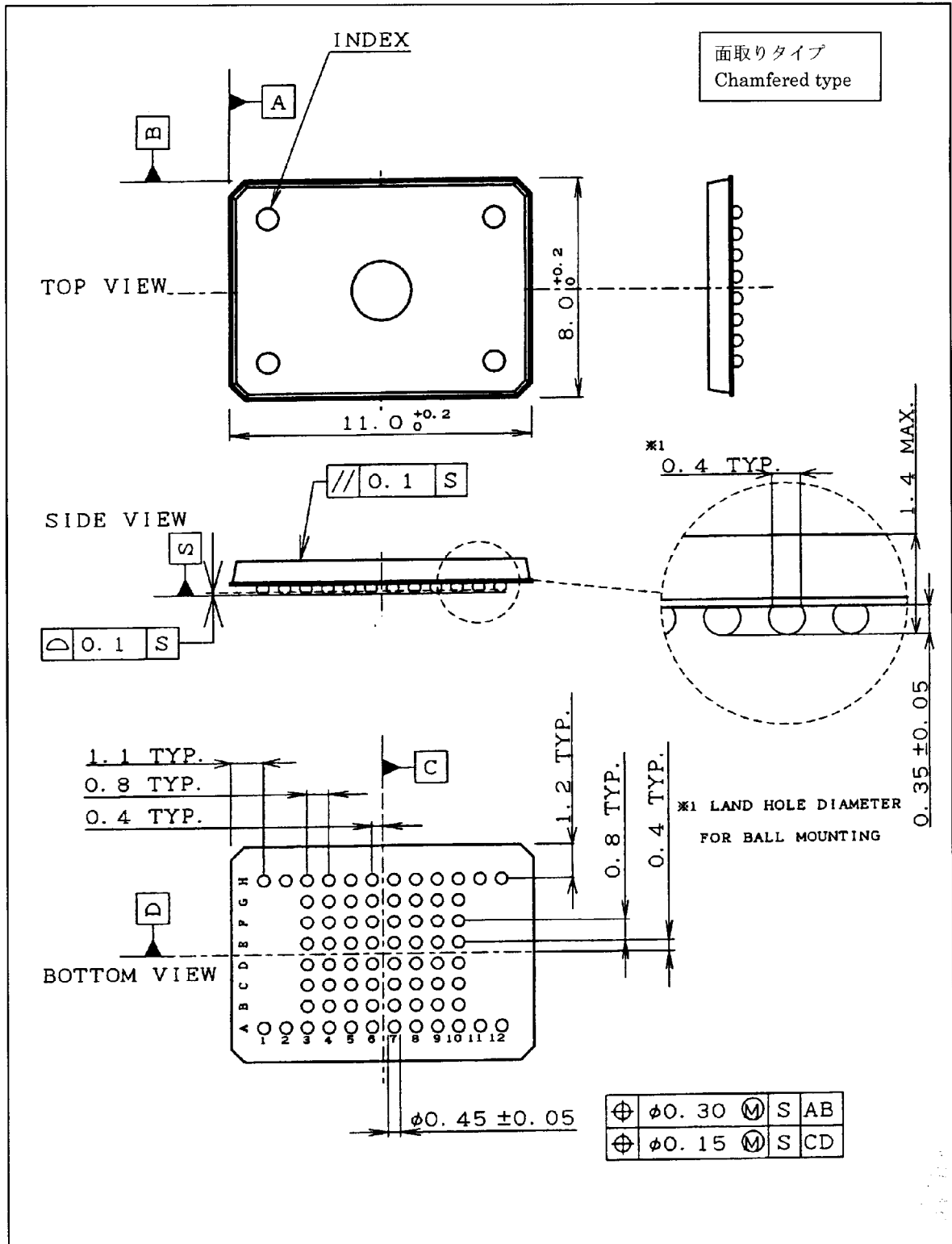

名称 NAME	FBGA072/064-P-0811 (LCSP072/064-P-0811)			備考 NOTE
DRAWING NO.	AA2078	単位 UNIT	mm	

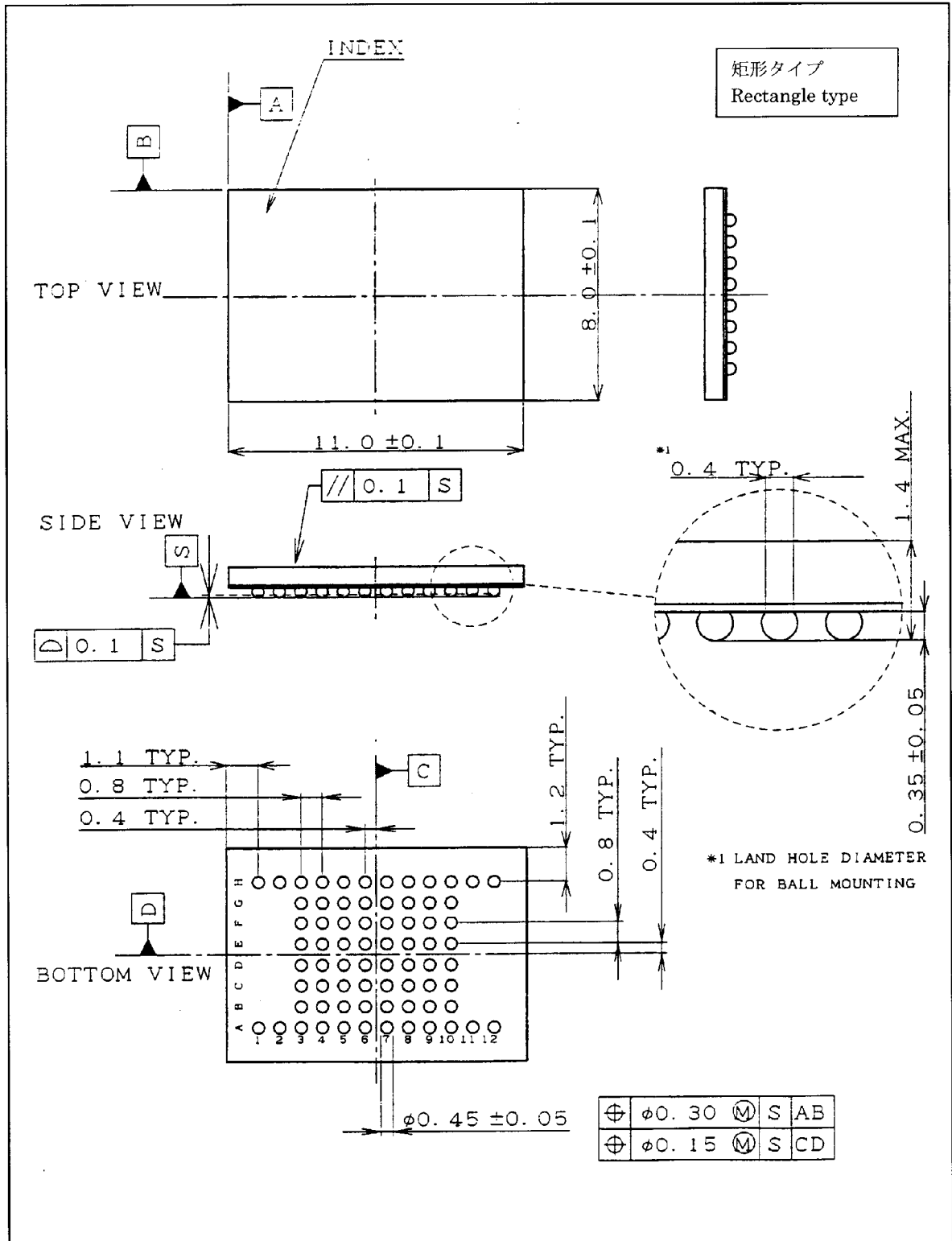

名称 NAME	LFBGA072/064-P-0811 (LCSP072/064-P-0811)			備考 NOTE
DRAWING NO.	AA2149	単位 UNIT	mm	

マークレイアウト図
Marking layout

面取りタイプ
Chamfered type

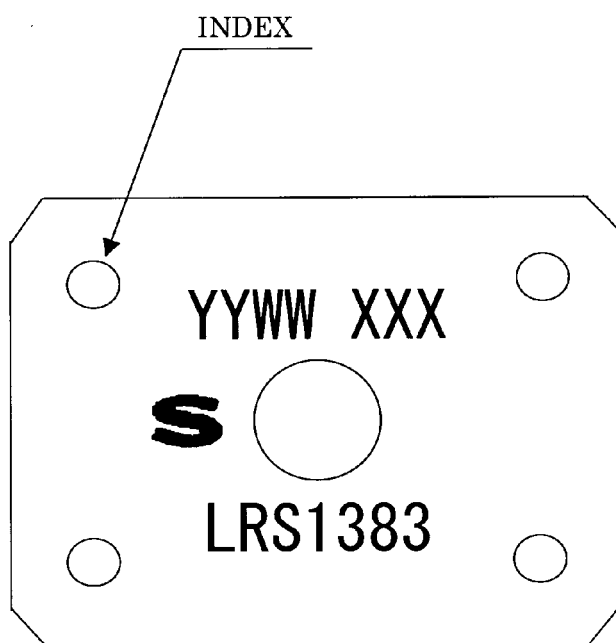

マークレイアウト図
Marking layout

矩形タイプ
Rectangle type

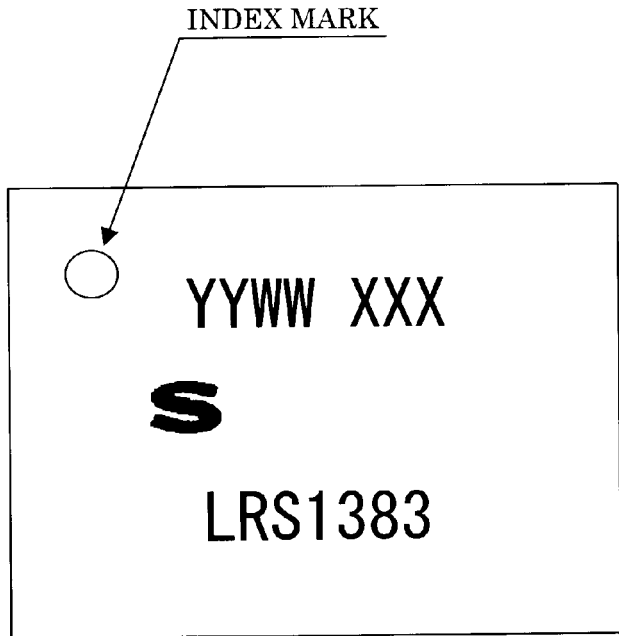

7.Packing Specifications (Dry packing for surface mount packages.)

7-1.Packing materials.

Material name	Material specifications	Purpose
Inner carton	Cardboard (2310 devices / inner carton max.)	Packing the devices. (10 trays / inner carton)
Tray	Conductive plastic (231 devices / tray)	Securing the devices.
Upper cover tray	Conductive plastic (1 tray / inner carton)	Securing the devices.
Laminated aluminum bag	Aluminum polyethylene	Keeping the devices dry.
Desiccant	Silica gel	Keeping the devices dry.
Label	Paper	Indicates part number, quantity, and packed date.
PP band	Polypropylene (3 pcs. / inner carton)	Securing the devices.
Outer carton	Cardboard (9240 devices / outer carton max.)	Outer packing.

(Devices must be placed on the tray in the same direction.)

7-2.Outline dimension of tray.

Refer to the attached drawing.

7-3.Outline dimension of carton.

Refer to the attached drawing.

8. Precautions for use.

- (1) Opening must be done on an anti-ESD treated workbench.
All workers must also have undergone anti-ESD treatment.
- (2) The trays have undergone either conductive or anti-ESD treatment.
If another tray is used, make sure it has also undergone conductive or anti-ESD treatment.
- (3) The devices should be mounted the devices within one year of the date of delivery.

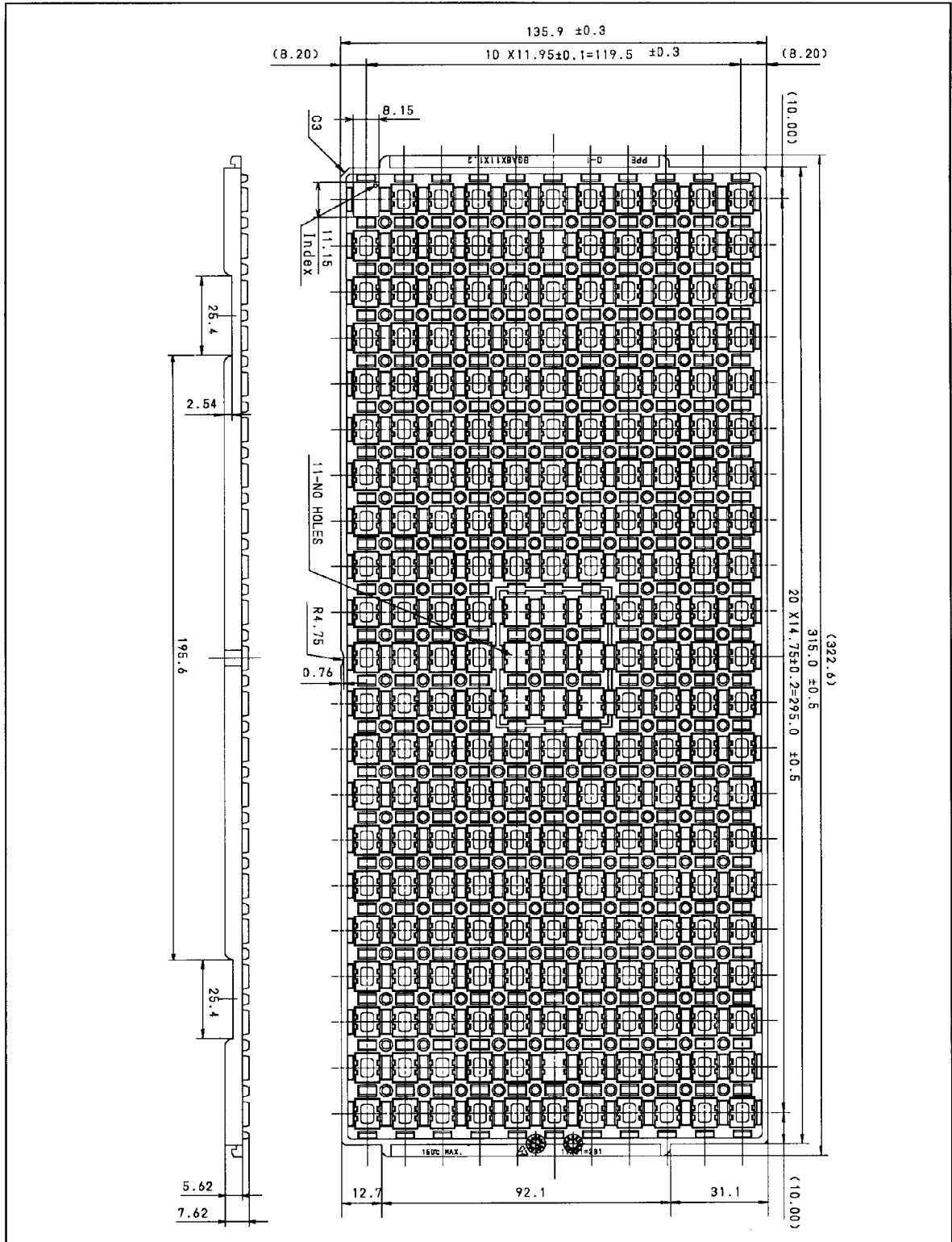

名称 NAME	BGA8X11X1.2	備考 NOTE
DRAWING NO.	CV867	単位 UNIT mm

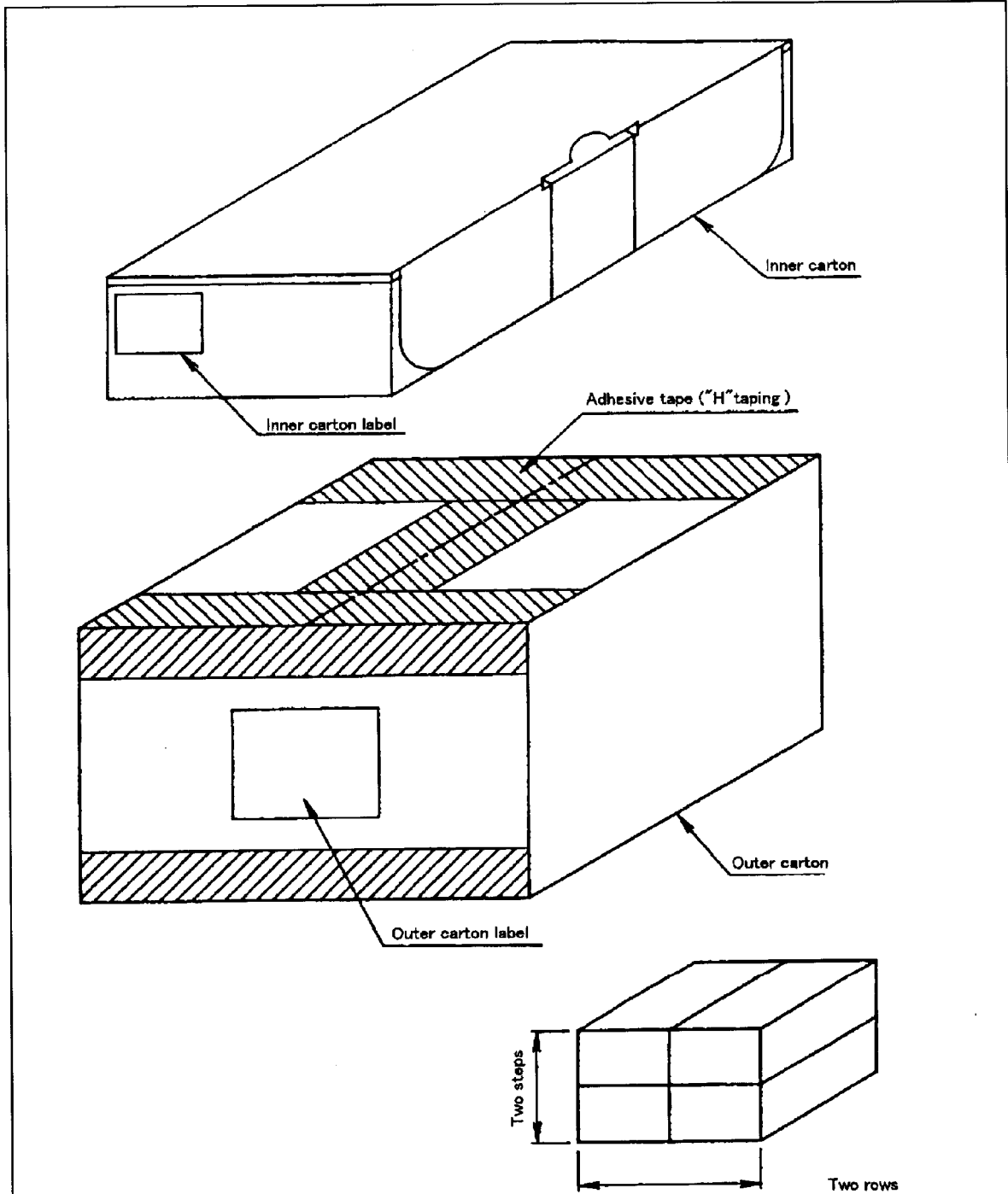

L × W × H

Inner carton - Outer dimensions : 348×152×90

Outer carton - Outer dimensions : 350×335×215

名称 NAME	トレイ品 包装仕様 Packing specifications		備考 NOTE
DRAWING NO.	BJ433J	単位 UNIT	
			出荷数量が端数の場合、本仕様と異なることがあります。 There is a possibility different from this specification when the number of shipments is fractions.

mm

Inner carton label

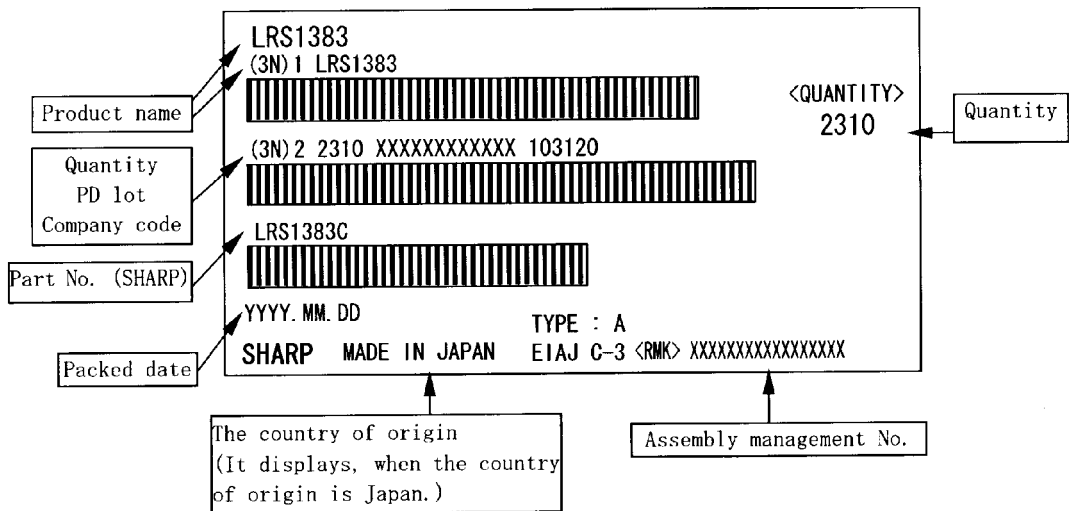

Outer carton label

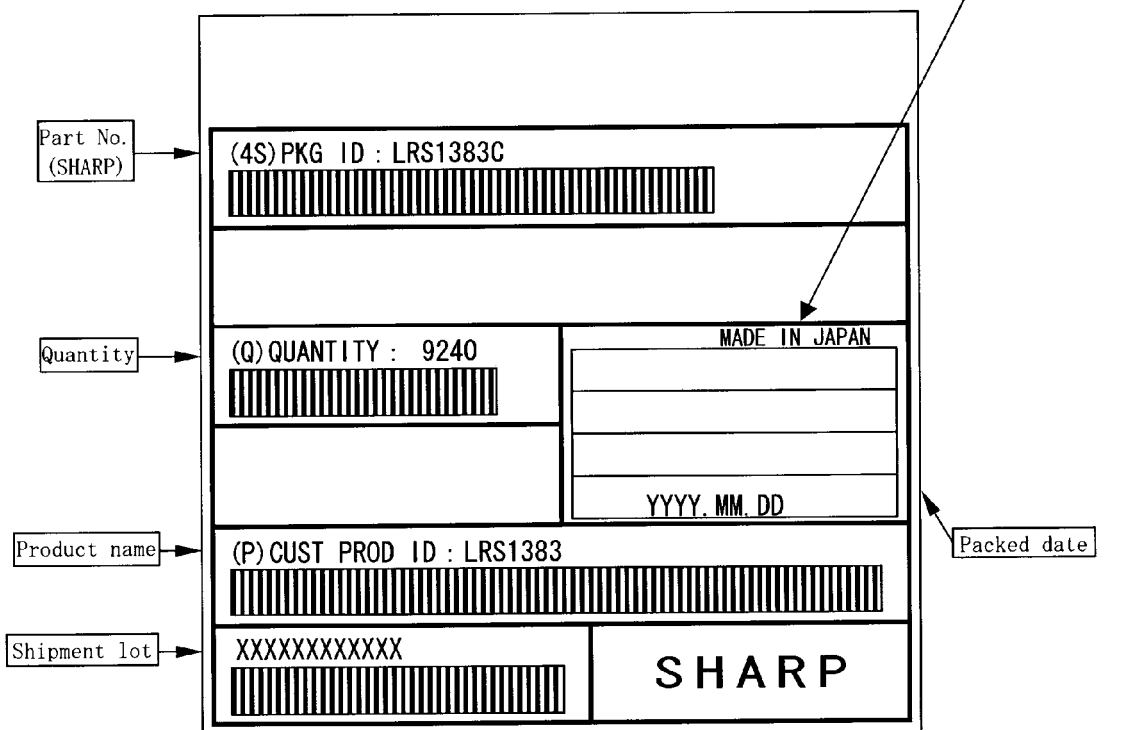

A-1 RECOMMENDED OPERATING CONDITIONS

A-1.1 At Device Power-Up

AC timing illustrated in Figure A-1 is recommended for the supply voltages and the control signals at device power-up. If the timing in the figure is ignored, the device may not operate correctly.

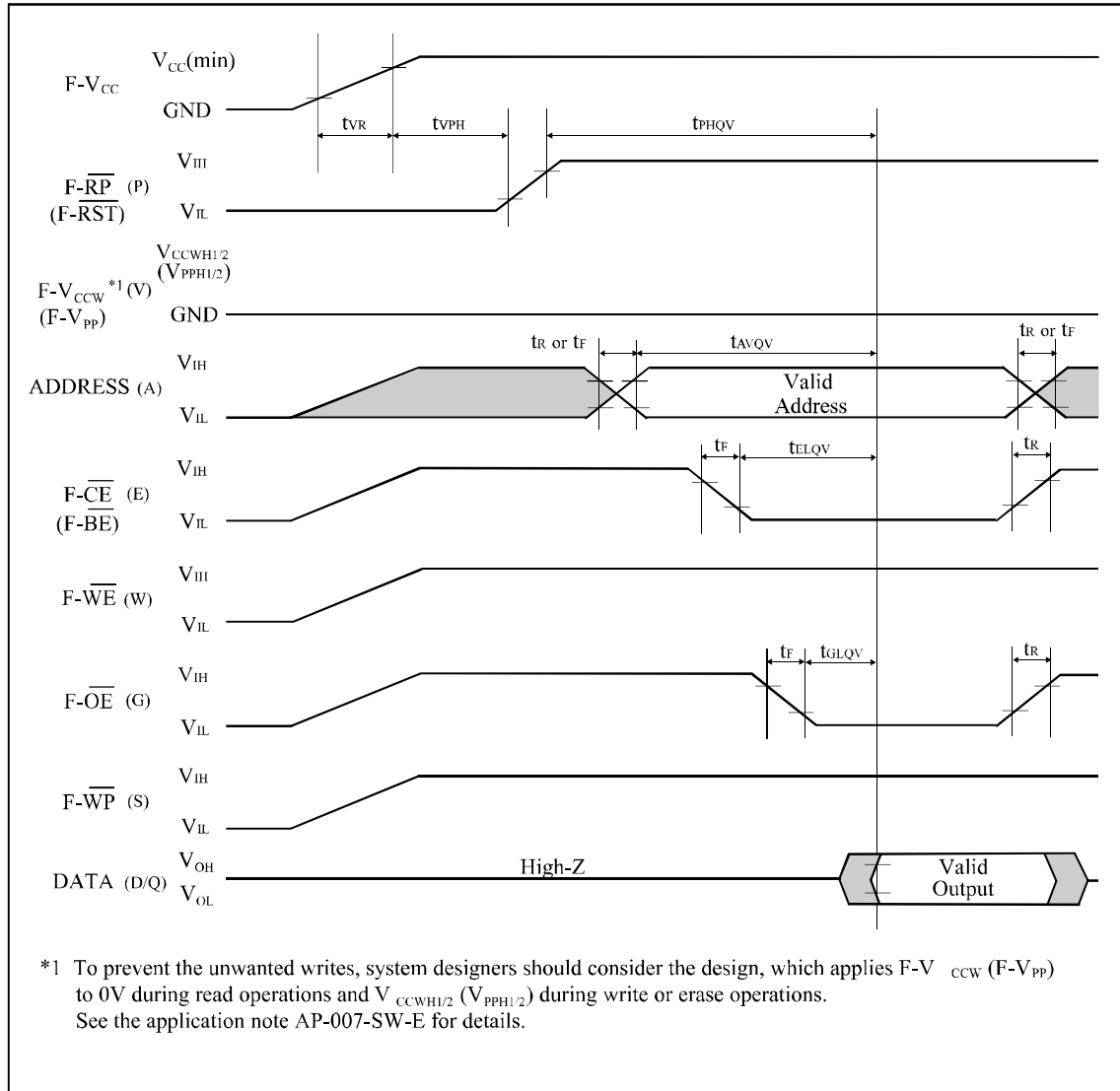

Figure A-1. AC Timing at Device Power-Up

For the AC specifications t_{VR} , t_r , t_f in the figure, refer to the next page. See the “AC Electrical Characteristics for Flash Memory” described in specifications for the supply voltage range, the operating temperature and the AC specifications not shown in the next page.

A-1.1.1 Rise and Fall Time

Symbol	Parameter	Notes	Min.	Max.	Unit
t_{VR}	F- V_{CC} Rise Time	1	0.5	30000	$\mu\text{s}/\text{V}$
t_R	Input Signal Rise Time	1, 2		1	$\mu\text{s}/\text{V}$
t_F	Input Signal Fall Time	1, 2		1	$\mu\text{s}/\text{V}$

NOTES:

1. Sampled, not 100% tested.
2. This specification is applied for not only the device power-up but also the normal operations.

A-1.2 Glitch Noises

Do not input the glitch noises which are below V_{IH} (Min.) or above V_{IL} (Max.) on address, data, reset, and control signals, as shown in Figure A-2 (b). The acceptable glitch noises are illustrated in Figure A-2 (a).

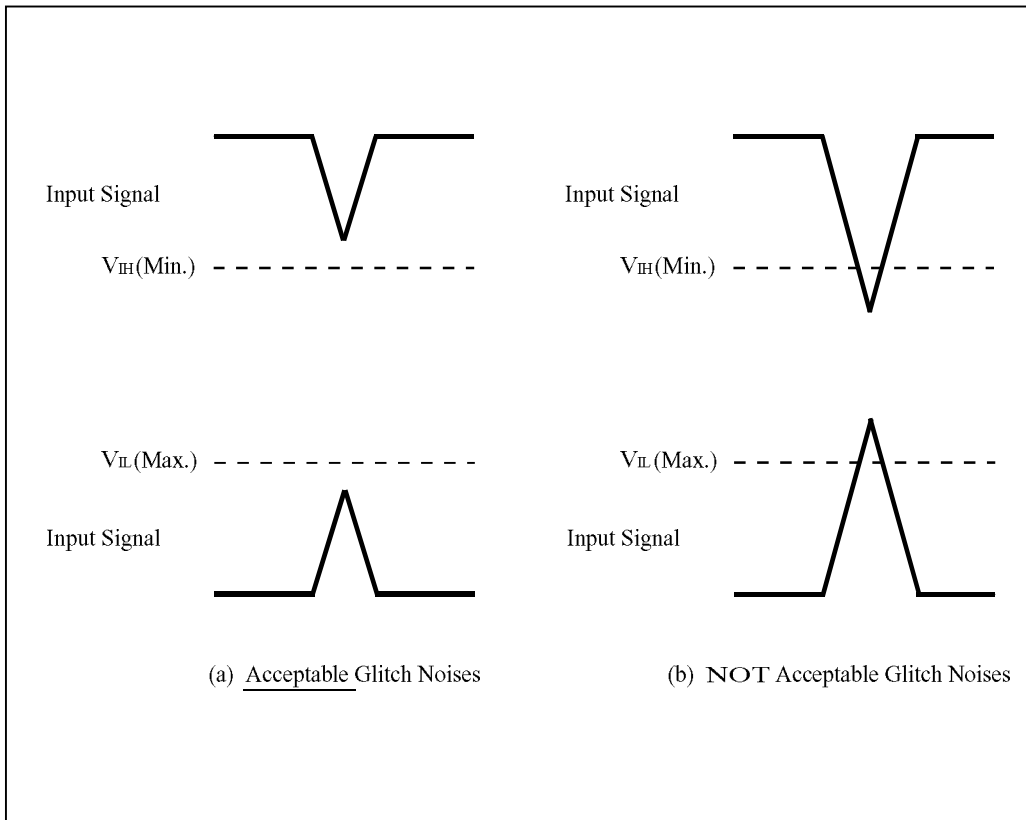

Figure A-2. Waveform for Glitch Noises

See the “DC Electrical Characteristics” described in specifications for V_{IH} (Min.) and V_{IL} (Max.).

A-2 RELATED DOCUMENT INFORMATION⁽¹⁾

Document No.	Document Name
AP-001-SD-E	Flash Memory Family Software Drivers
AP-006-PT-E	Data Protection Method of SHARP Flash Memory
AP-007-SW-E	RP#, V_{pp} Electric Potential Switching Circuit

NOTE:

1. International customers should contact their local SHARP or distribution sales office.

SPECIFICATIONS ARE SUBJECT TO CHANGE WITHOUT NOTICE.

Suggested applications (if any) are for standard use; See Important Restrictions for limitations on special applications. See Limited Warranty for SHARP's product warranty. The Limited Warranty is in lieu, and exclusive of, all other warranties, express or implied. ALL EXPRESS AND IMPLIED WARRANTIES, INCLUDING THE WARRANTIES OF MERCHANTABILITY, FITNESS FOR USE AND FITNESS FOR A PARTICULAR PURPOSE, ARE SPECIFICALLY EXCLUDED. In no event will SHARP be liable, or in any way responsible, for any incidental or consequential economic or property damage.

SHARP®

NORTH AMERICA

SHARP Microelectronics of the Americas
5700 NW Pacific Rim Blvd.
Camas, WA 98607, U.S.A.
Phone: (1) 360-834-2500
Fax: (1) 360-834-8903
Fast Info: (1) 800-833-9437
www.sharpsma.com

EUROPE

SHARP Microelectronics Europe
Division of Sharp Electronics (Europe) GmbH
Sonninstrasse 3
20097 Hamburg, Germany
Phone: (49) 40-2376-2286
Fax: (49) 40-2376-2232
www.sharpsme.com

JAPAN

SHARP Corporation
Electronic Components & Devices
22-22 Nagaïke-cho, Abeno-Ku
Osaka 545-8522, Japan
Phone: (81) 6-6621-1221
Fax: (81) 6117-725300/6117-725301
www.sharp-world.com

TAIWAN

SHARP Electronic Components
(Taiwan) Corporation
8F-A, No. 16, Sec. 4, Nanking E. Rd.
Taipei, Taiwan, Republic of China
Phone: (886) 2-2577-7341
Fax: (886) 2-2577-7326/2-2577-7328

SINGAPORE

SHARP Electronics (Singapore) PTE., Ltd.
438A, Alexandra Road, #05-01/02
Alexandra Technopark,
Singapore 119967
Phone: (65) 271-3566
Fax: (65) 271-3855

KOREA

SHARP Electronic Components
(Korea) Corporation
RM 501 Geosung B/D, 541
Dohwa-dong, Mapo-ku
Seoul 121-701, Korea
Phone: (82) 2-711-5813 ~ 8
Fax: (82) 2-711-5819

CHINA

SHARP Microelectronics of China
(Shanghai) Co., Ltd.
28 Xin Jin Qiao Road King Tower 16F
Pudong Shanghai, 201206 P.R. China
Phone: (86) 21-5854-7710/21-5834-6056
Fax: (86) 21-5854-4340/21-5834-6057
Head Office:
No. 360, Bashen Road,
Xin Development Bldg. 22
Waigaoqiao Free Trade Zone Shanghai
200131 P.R. China
Email: smc@china.global.sharp.co.jp

HONG KONG

SHARP-ROXY (Hong Kong) Ltd.
3rd Business Division,
17/F, Admiralty Centre, Tower 1
18 Harcourt Road, Hong Kong
Phone: (852) 28229311
Fax: (852) 28660779
www.sharp.com.hk
Shenzhen Representative Office:
Room 13B1, Tower C,
Electronics Science & Technology Building
Shen Nan Zhong Road
Shenzhen, P.R. China
Phone: (86) 755-3273731
Fax: (86) 755-3273735