

LS037V7DW01

TFT-LCD Module

Spec. Issue Date: May 17, 2006

No: LCP-06008A

PREPARED BY : DATE
T.Nishioka : Mar. 1. 2006

CHECKED BY : DATE
M. Inoue : Mar. 1. 2006

S H A R P

MOBILE LIQUID CRYSTAL DISPLAY GROUP
SHARP CORPORATION

S P E C I F I C A T I O N

SPEC No. LCP-06008A

FILE No.

ISSUE : Mar. 1. 2006

PAGE : 23 pages

APPLICABLE GROUP
MOBILE LIQUID CRYSTAL DISPLAY
GROUP

DEVICE SPECIFICATION FOR

CG-Silicon TFT-LCD module

MODEL No. **LS037V7DW01**

CUSTOMER'S APPROVAL

DATA _____

BY _____

PRESENTED

BY 中 辻 晴 夫

H. NAKATSUJI

DIVISION DEPUTY GENERAL MANAGER &

DEPARTMENT GENERAL MANAGER

ENGINEERING DEPT. V

MOBILE LCD DESIGN CENTER I

MOBILE LIQUID CRYSTAL DISPLAY GROUP

SHARP CORPORATION

NOTICE

This publication is the proprietary of SHARP and is copyrighted, with all rights reserved. Under the copyright laws, no part of this publication may be reproduced or transmitted in any form or by any means, electronic or mechanical for any purpose, in whole or in part, without the express written permission of SHARP. Express written permission is also required before any use of this publication may be made by a third party.

The application circuit examples in this publication are provided to explain the representative applications of SHARP's devices and are not intended to guarantee any circuit design or permit any industrial property right or other rights to be executed. SHARP takes no responsibility for any problems related to any industrial property right or a third party resulting from the use of SHARP's devices, except for those resulting directly from device manufacturing processes.

In the absence of confirmation by device specification sheets, SHARP takes no responsibility for any defects that occur in equipment using any of SHARP's devices, shown in catalogs, data books, etc. Contact SHARP in order to obtain the latest device specification sheets before using any SHARP's device.

SHARP reserves the right to make changes in the specifications, characteristics, data, materials, structures and other contents described herein at any time without notice in order to improve design or reliability. Contact SHARP in order to obtain the latest specification sheets before using any SHARP's device. Manufacturing locations are also subject to change without notice.

Observe the following points when using any device in this publication. SHARP takes no responsibility for damage caused by improper use of the devices.

The devices in this publication are designed for use in general electronic equipment designs, such as:

- Personal computers • Office automation • Telecommunication equipment
- Test and measurement equipment • Industrial control
- Audio visual and multimedia equipment • Consumer electronics

The appropriate design measures should be taken to ensure reliability and safety when SHARP's devices are used for equipment such as:

- Transportation control and safety equipment(i.e., aircraft, trains, automobiles, etc.)
- Traffic signals • Gas leakage sensor breakers
- Alarm equipment • Various safety devices etc.

SHARP's devices shall not be used for equipment that requires extremely high level of reliability, such as:

- Military and space applications • Nuclear power control equipment
- Medical equipment for life support

Contact a SHARP representative, in advance, when intending to use SHARP's devices for any "specific" applications other than those recommended by SHARP.

Contact and consult with a SHARP representative if there are any questions about the contents of this publication.

(1) Application

This literature applies to LS037V7DW01.

(2) Overview

This module is a color transfective and active matrix LCD module incorporating CG-Silicon TFT (Continuous Grain-Silicon Thin Film Transistor). It is composed of a color TFT-LCD panel, driver ICs (with control Function), an FPC(with DC-DC Converter), a back light, a touch panel and a back sealed casing.

It is composed control circuit. Graphics and texts can be displayed on a 480×3×640 dots panel with 262,144 colors by supplying.

This LCD module has multi resolution and multi colors functions. A resolution mode is selective in VGA (480H×640V) or QVGA (240H×320V). A Color mode is selective in 262,144 colors (18bit RGB) or 8 colors (3bit RGB).

It is a wide viewing-angle-mode (Vertical viewing angle:(±80°) Horizontal viewing angle: (±80°) ,CR≥5).

(3) Mechanical specifications

Table 1

Parameter	Specifications	Units	Remarks
Screen size (Diagonal)	9.4 [3.7"] Diagonal	cm	
Display active area	56.16 (H) ×74.88 (V)	mm	
Touch panel active area	57.4 (H) ×76.1 (V)	mm	
Pixel format	480(H)×640(V) (1 pixel = R+G+B dots)	pixels	
Dot pitch	0.039 (H) ×0.117 (V)	mm	
Pixel configuration	R,G,B vertical stripe		
Display mode	Normally Black		
Unit outline dimension	65.0(W)×89.2(H)×4.4(D)	mm	【Note3-1】
Mass	T y p . 4 8	g	
Surface hardness	3H		

【Note 3-1】 Excluding protrusion. For detailed measurements and tolerances, please refer to Fig. 1.

(4) Pixel configuration

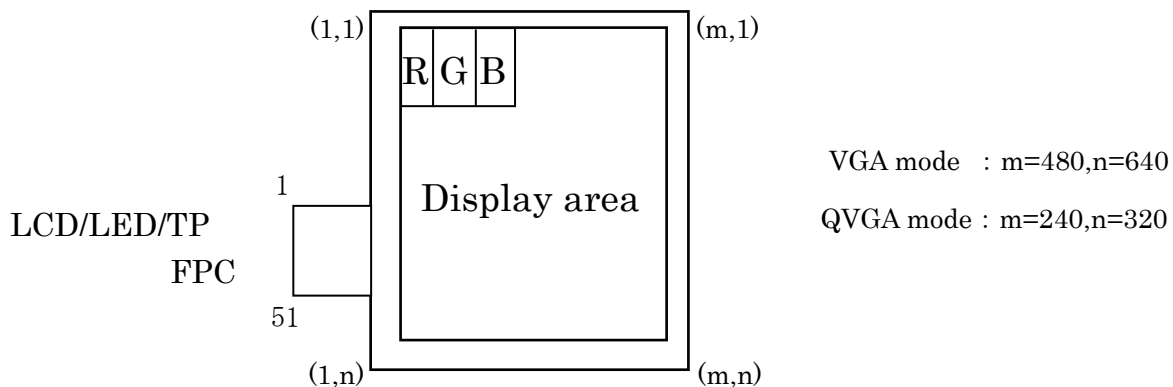

(5) Input/Output terminal

5-1) TFT-LCD panel and Backlight driving section

Table2

Pin No.	Symbol	I/O	Description	Remarks
1	LED+	—	LED power supply(High Voltage)	【Note5-1】
2	NC	—		
3	LED-	—	LED power supply(Low Voltage)	
4	NC	—		
5	T4	—	Touch panel lower electrode(Right side)	
6	T3	—	Touch panel upper electrode(6 o'clock side)	
7	T2	—	Touch panel lower electrode(Left side)	
8	T1	—	Touch panel upper electrode(12 o'clock side)	
9	GND	—	Ground	
10	RESB	I	Reset signal	【Note5-2】
11	GND	—	Ground	
12	MO	I	Selection for resolution(VGA/QVGA)	【Note5-3】
13	UD	I	Selection for vertical scanning direction	【Note5-4】
14	LR	I	Selection for horizontal scanning direction	【Note5-5】
15	INI	I	Power on control	【Note5-2】
16	DEN	I	Data enable signal	【Note5-6】
17	GND	—	Ground	
18	VSYNC	I	Vertical synchronizing signal	
19	GND	—	Ground	
20	HSYNC	I	Horizontal synchronizing signal	
21	GND	—	Ground	
22	CLKIN	I	System clock signal	
23	GND	—	Ground	
24	VCC	—	Power supply(3.3V)	【Note5-2】
25	VCC	—	Power supply(3.3V)	【Note5-2】
26	VCC	—	Power supply(3.3V)	【Note5-2】
27	GND	—	Ground	
28	B5	I	Blue data signal(MSB)	
29	B4	I	Blue data signal	
30	B3	I	Blue data signal	
31	B2	I	Blue data signal	
32	B1	I	Blue data signal	
33	B0	I	Blue data signal(LSB)	
34	GND	—	Ground	
35	G5	I	Green data signal(MSB)	
36	G4	I	Green data signal	

Pin No.	Symbol	I/O	Description	Remarks
37	G3	I	Green data signal	
38	G2	I	Green data signal	
39	G1	I	Green data signal	
40	G0	I	Green data signal(LSB)	
41	GND	—	Ground	
42	R5	I	Red data signal(MSB)	
43	R4	I	Red data signal	
44	R3	I	Red data signal	
45	R2	I	Red data signal	
46	R1	I	Red data signal	
47	R0	I	Red data signal(LSB)	
48	GND	—	Ground	
49	SMPSYNC	I	Selection for Vertical/ Horizontal synchronizing signal timing(clock timing)	【Note5-7】
50	SMPDATA	I	Selection for Red, Green and Blue data signal timing (clock timing)	【Note5-7】
51	ID1	—	Ground	

【Note5-1】 When superfluous current flows, please intercept current with a fuse etc.

【Note5-2】 See section(7-1)-(A) ”※Cautions when you turn on or off the power supply”.

【Note5-3】 Selection for resolution mode

MO	Resolution
Low	VGA(480RGB×640)
High	QVGA(240RGB×320)

【Note5-4】 Selection for vertical scanning direction

U/L	Scanning direction (Pixel configuration)
High	Conventional scanning (X , 1) ↓ (X , Y)
Low	Inverted scanning (X , 1) ↑ (X , Y)

VGA mode: Y=640, QVGA mode: Y=320

【Note5-5】 Selection for horizontal scanning direction

LBR	Scanning direction (Pixel configuration)
High	Conventional scanning (1,Y) → (X,Y)
Low	Inverted scanning (1,Y) ← (X,Y)

VGA mode: X=480, QVGA mode: X=240

【Note5-6】

DEN makes it possible to take effective data timing. Horizontal Data Sampling Timing is shown in 7-2) Timing Characteristics of input signals.

【Note5-7】 Selection for synchronizing signal and data signal timing(clock timing)

SMPSYNC	Selection for Vertical/ Horizontal synchronizing signal timing(clock timing)	SMPDATA	Selection for Red,Green and Blue data signal timing(clock timing)
High	Rise edge of clock(CLKIN)	High	Rise edge of clock(CLKIN)
Low	Fall edge of clock(CLKIN)	Low	Fall edge of clock(CLKIN)

(6)Absolute Maximum Ratings

Table 3

Parameter	Symbol	Condition	Ratings	Unit	Remark
Power supply (COG driver / Digital)	VSHD	Ta=25°C	-0.3~+4.0	V	
Input voltage (Digital)	VID	Ta=25°C	-0.3~VSHD+0.3	V	[Terminal]
Touch panel input voltage	VIT	Ta=25°C	7.0	V	【Note6-1】
Operating temperature(Panel surface)	T opp	—	-10~60	°C	【Note6-2】
Storage temperature	T stg	—	-20~70	°C	【Note6-2】
LED current	I _L	Ta=25°C	30	mA	【Note6-3】

[Terminal] INI,VS SYNC,HS SYNC,MO,UD,LR,CLK,R0~R5,G0~G5,B0~B5,DEN,RESB

【Note6-1】 Applies to Touch panel input terminal.(xL,xR,yU,yD)

【Note6-2】 Humidity: 95%RH Max.(at Ta ≤ 40°C). Maximum wet-bulb temperature is less than 39°C (at Ta > 40°C). Condensation of dew must be avoided.

【Note6-3】 (Provisional plan) LED current should be as per below figure.

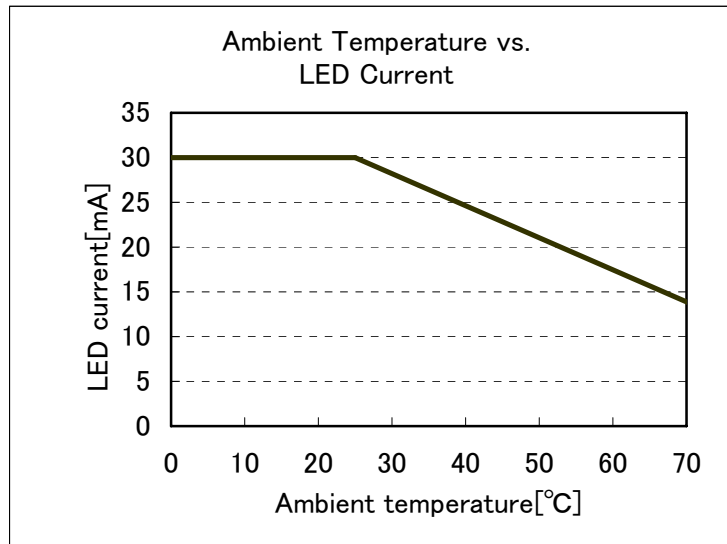

(7)Electrical characteristics

7-1) Recommended operating conditions

A) TFT-LCD panel driving section

Table4

GND=0V

Parameter	Symbol	Min.	Typ.	Max.	Unit	Remarks
Supply voltage for COG driver	VSHD	+3.0	+3.3	+3.6	V	
Input voltage (Low)	VILS	GND	-	0.2VSHD	V	【Note 7-1】
Input voltage (High)	VIHS	0.8VSHD	-	VSHD	V	【Note 7-1】
Input current (Low)	IILS	-	-	10	μA	【Note 7-1】
Input current (High)	IIHS	-	-	10	μA	【Note 7-1】

※Cautions when you turn on or off the power supply

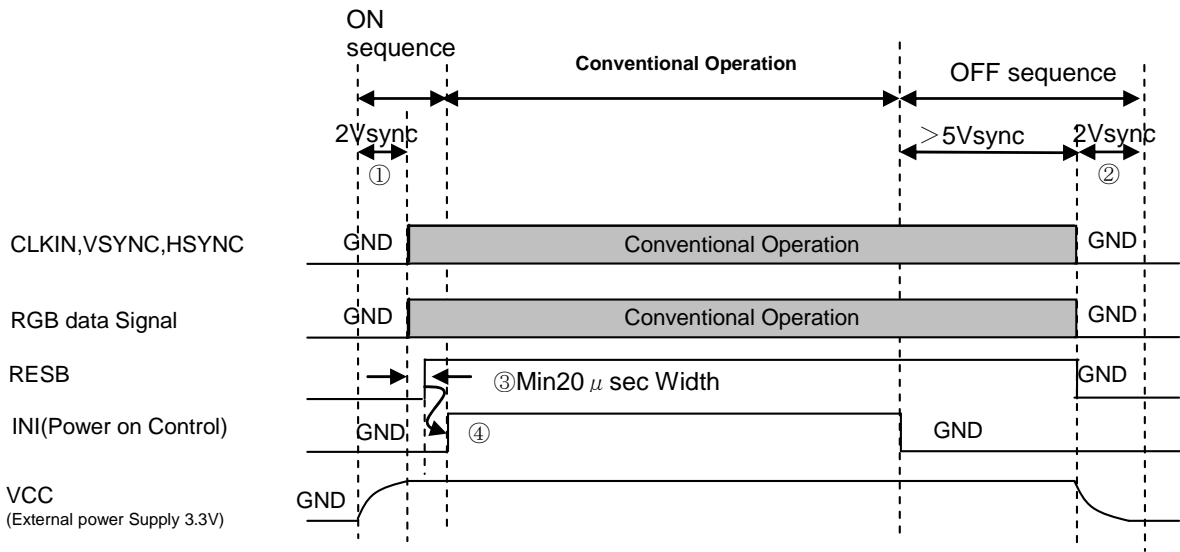

- (1) After VCC is ON ,please make sure to start HVIF(CLK,HSYNC,VSYNC,RGB data signal) synchronized signal before INI(Power on control) becomes High.
- (2) Please keep HVIF(CLK,HSYNC,VSYNC,RGB data signal) synchronized signal High for more than 5 vertical period after INI becomes Low to shut down VCC.
- (3) Stabilize VCC(+3.3V) within double vertical periods.
- (4) VCC is stabilized to GND within double vertical periods.
- (5) When the power supply is on again after Power Supply Off sequence ,please put the RESB signal before Power Supply On sequence. RESB signal needs LOW level more than 20μsec after VCC(+3.3V) ON.
- (6) Please Set RESB signal before INI Signal.

【Note 7-1】 INI,VSYNC,HSYNC,MO,UD,LR,CLK,R0~R5,G0~G5,B0~B5,DEN,RESB terminals are applied. Each voltage should be kept to satisfy absolute maximum ratings. If the applied voltage goes beyond absolute maximum ratings, the LCD module may be broken eternally.

B) Back light driving section

Table 5

Ta=25

Parameter	Symbol	MIN	TYP	MAX	Units	Remarks terminal
LED voltage(VL)	V_L	—	27.9	31.5	V	【Note 7-2】
LED current(IL)	I_L	—	16	20	mA	
Power consumption	W_L	—	446.4	630	mW	【Note 7-3】

【Note 7-2】 V_L (TYP) at I_L (16mA). V_L (MAX) at I_L (20mA).

【Note 7-3】 Calculated reference value. $W_L=(V_L \times I_L)$

7-2) Timing Characteristics of input signals

Table 6 AC Characteristics

Parameter	Symbol	MODE	Min.	Typ.	Max.	Unit	Note
CLK Period	t_{CLK}	VGA QVGA	38 152	39.7 158.8	41.7 167	ns	CLK
CLK Low Width	t_{CLKL}		15	-	-	ns	
CLK High Width	t_{CLKH}		15	-	-	ns	
Data setup time	t_{DS}		10	-	-	ns	R0~R5, G0~G5, B0~B5
Data hold time	t_{DH}		10	-	-	ns	
Pulse width of DEN	t_{HHW}	VGA QVGA	-	480 240	-		
Period of HSYNC	t_{HS}	VGA QVGA	-	648 324	-	CLK	HSYNC
Pulse width of HSYNC	t_{hsw}		-	2	-	CLK	
HSYNC setup time	t_{HSYS}		10	-	-	ns	
HSYNC hold time	t_{HSYH}		10	-	-	ns	
Horizontal Back Porch	t_{HBP}	VGA QVGA	28 14	78 38	166 82	CLK	
Horizontal Front Porch	t_{HFP}	VGA QVGA	0 0	88 44	138 68	CLK	
Period of VSYNC	t_{VS}		57	59.94	63	Hz	VSYNC
Period of VSYNC	t_{VS}	VGA QVGA	- -	648 324	-	HCYC	
Pulse width of VSYNC	t_{vsw}		-	1	-	HCYC	
VSYNC setup time	t_{VSYs}		10	-	-	ns	
VSYNC hold time	t_{VSYH}		10	-	-	ns	
VSYNC-HSYNC phase difference	t_{VHD}		0		HCYC-2	CLK	
Input Signal 1 Rising Time	t_{RISE1}		-	-	5	ns	【Note 7-5】
Input Signal 1 Falling Time	t_{FALL1}		-	-	5	ns	【Note 7-5】
Input Signal 2 Rising Time	t_{RISE2}		-	-	5	μ s	【Note 7-6】
Input Signal 2 Falling Time	t_{FALL2}		-	-	5	μ s	【Note 7-6】
Reset Pulse Width	t_{RESW}		20	-	-	μ s	【Note 7-7】

【Note 7-4】 HCYC = HSYNC Period(VGA:Typ.648CLK, QVGA:Typ.324CLK)

【Note 7-5】 VSYNC,HSYNC,CLK,R0~R5,G0~G5,B0~B5,DEN terminals are applied.

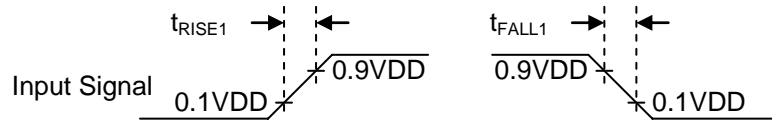

【Fig 7-1 Input Signal Rising/Falling Timing】

【Note 7-6】 INI,RESB terminals are applied.

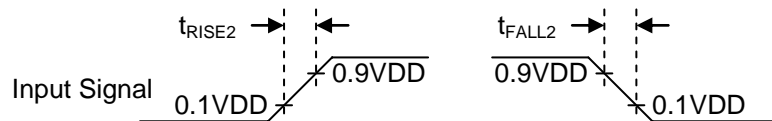

【Fig 7-2 Input Signal Rising/Falling Timing】

【Note 7-7】 Reset Signal Timing chart

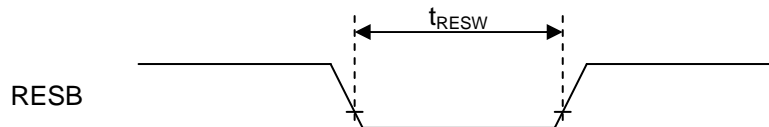

【Fig 7-3 Reset Timing Signal】

7-3)Power consumption

Measurement condition : Vsync=59.94Hz,Hsync=38.84kHz,CLK=25.17MHz,Ta=25°C (VGA Mode)

Table 7

(when conventional scan mode)

Parameter	Sym	Conditions	MIN	TYP	MAX	Unit	Remarks
VSHD Total(Digital+Analog)	ISHD	VSHD=+3.3V	—	45	75	mA	【Note7-8】

【Note 7-8】 White Pattern

[Portrait VGA Mode Timing Chart]

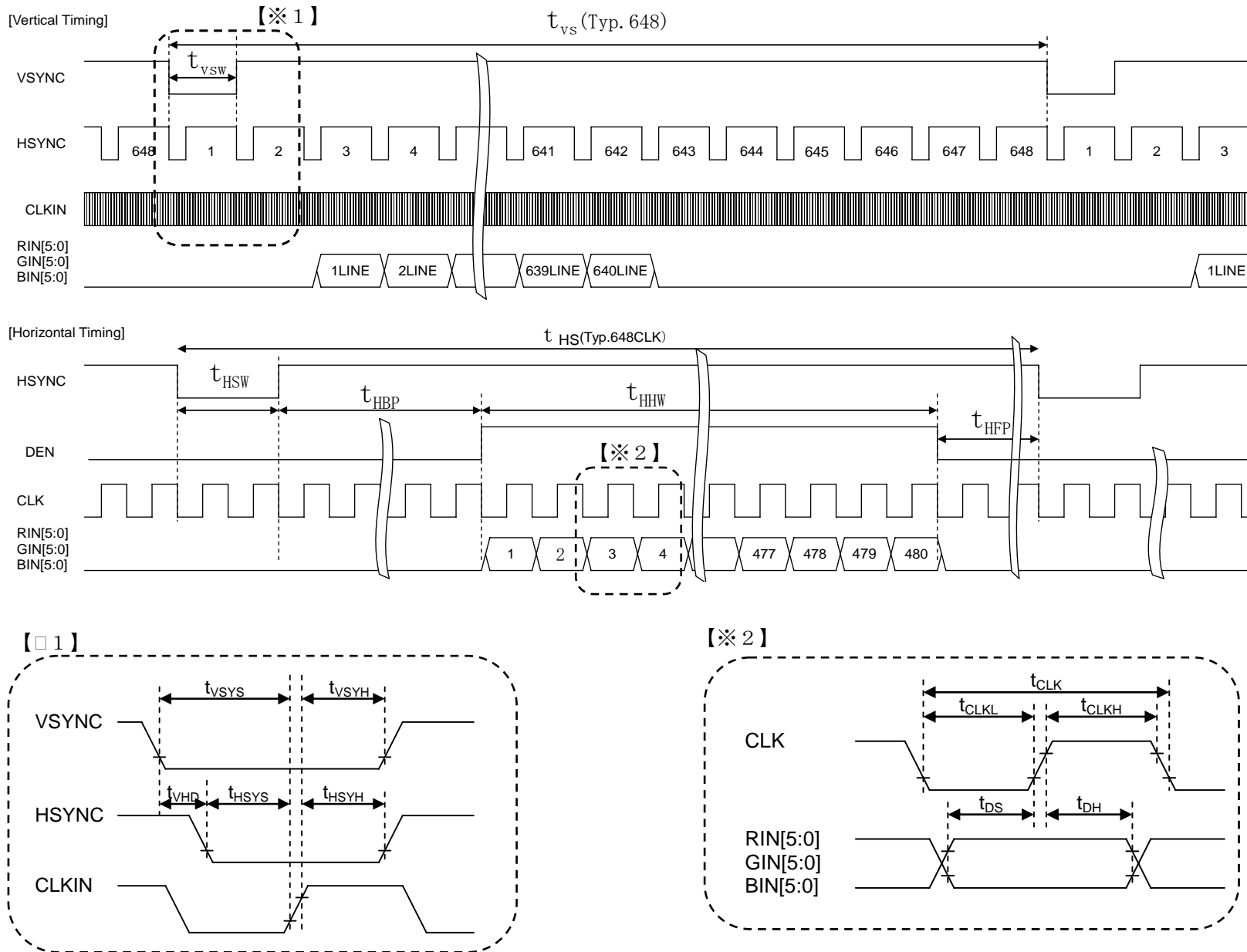

Fig 7-3 LCDIF signal timing in Portrait VGA mode

[Portrait QVGA Mode Timing Chart]

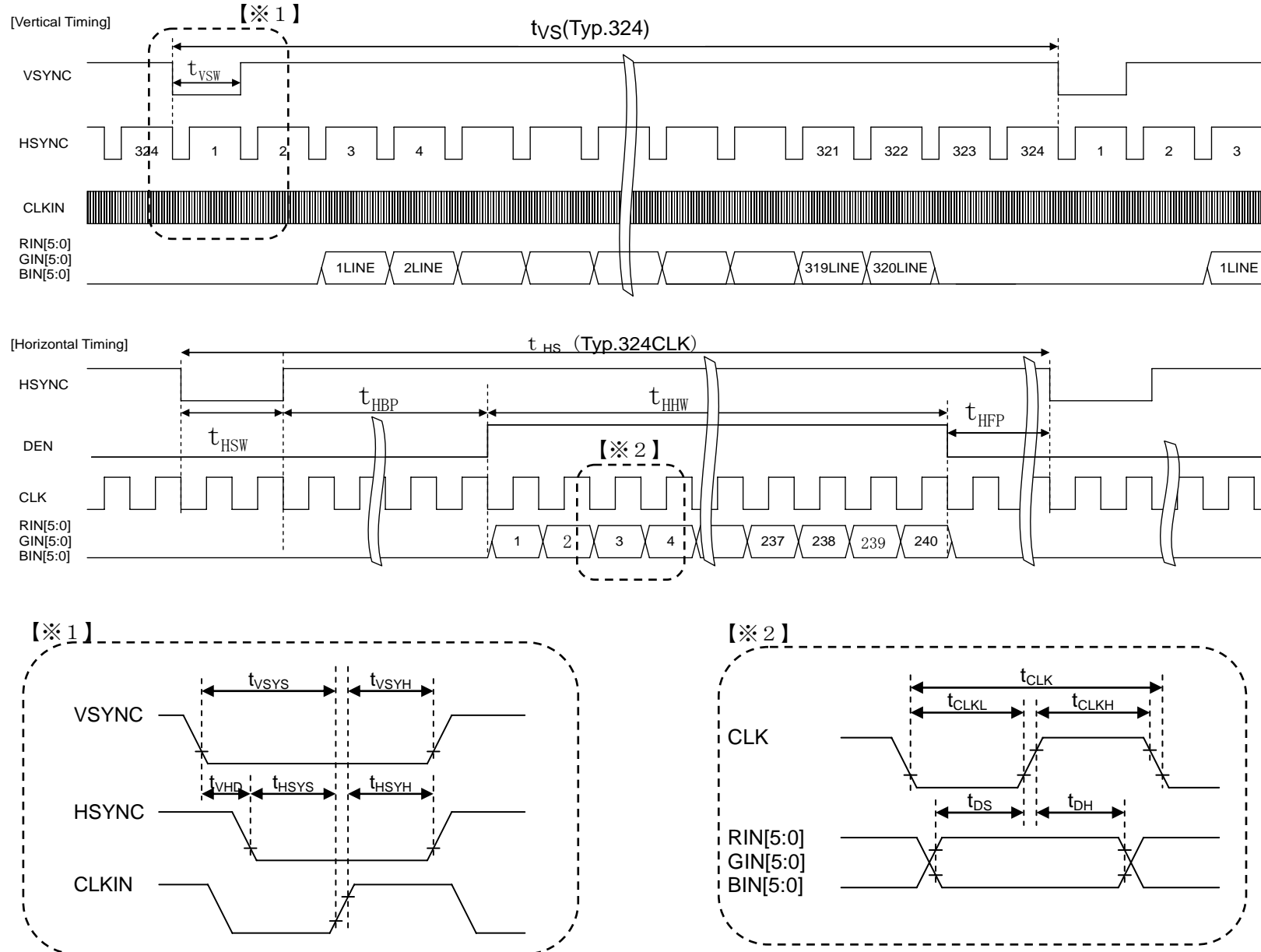

Fig 7-4 LCDIF signal timing in Portrait QVGA mode

(8) Input Signals, Basic Display Color and Gray Scale of Each Color

Table 8 18bit RGB color display mode

	Colors & Gray scale	Data signal																		
		Gray Scale	R0	R1	R2	R3	R4	R5	G0	G1	G2	G3	G4	G5	B0	B1	B2	B3	B4	B5
Basic color	Black	—	0	0	0	0	0	0	0	0	0	0	0	0	0	0	0	0	0	0
	Blue	—	0	0	0	0	0	0	0	0	0	0	0	0	1	1	1	1	1	1
	Green	—	0	0	0	0	0	0	1	1	1	1	1	1	0	0	0	0	0	0
	Cyan	—	0	0	0	0	0	0	1	1	1	1	1	1	1	1	1	1	1	1
	Red	—	1	1	1	1	1	1	0	0	0	0	0	0	0	0	0	0	0	0
	Magenta	—	1	1	1	1	1	1	0	0	0	0	0	0	1	1	1	1	1	1
	Yellow	—	1	1	1	1	1	1	1	1	1	1	1	1	0	0	0	0	0	0
	White	—	1	1	1	1	1	1	1	1	1	1	1	1	1	1	1	1	1	1
Gray Scale of red	Black	GS0	0	0	0	0	0	0	0	0	0	0	0	0	0	0	0	0	0	0
	↑	GS1	1	0	0	0	0	0	0	0	0	0	0	0	0	0	0	0	0	0
	Darker	GS2	0	1	0	0	0	0	0	0	0	0	0	0	0	0	0	0	0	0
	↑	↓				↓					↓					↓				
	↓	↓				↓					↓					↓				
	Brighter	GS61	1	0	1	1	1	1	0	0	0	0	0	0	0	0	0	0	0	0
	↓	GS62	0	1	1	1	1	1	0	0	0	0	0	0	0	0	0	0	0	0
	Red	GS63	1	1	1	1	1	1	0	0	0	0	0	0	0	0	0	0	0	0
Gray Scale of green	Black	GS0	0	0	0	0	0	0	0	0	0	0	0	0	0	0	0	0	0	0
	↑	GS1	0	0	0	0	0	0	1	0	0	0	0	0	0	0	0	0	0	0
	Darker	GS2	0	0	0	0	0	0	0	1	0	0	0	0	0	0	0	0	0	0
	↑	↓				↓					↓					↓				
	↓	↓				↓					↓					↓				
	Brighter	GS61	0	0	0	0	0	0	1	0	1	1	1	1	0	0	0	0	0	0
	↓	GS62	0	0	0	0	0	0	0	1	1	1	1	1	0	0	0	0	0	0
	Green	GS63	0	0	0	0	0	0	1	1	1	1	1	1	0	0	0	0	0	0
Gray Scale of bleu	Black	GS0	0	0	0	0	0	0	0	0	0	0	0	0	0	0	0	0	0	0
	↑	GS1	0	0	0	0	0	0	0	0	0	0	0	0	1	0	0	0	0	0
	Darker	GS2	0	0	0	0	0	0	0	0	0	0	0	0	0	1	0	0	0	0
	↑	↓				↓					↓					↓				
	↓	↓				↓					↓					↓				
	Brighter	GS61	0	0	0	0	0	0	0	0	0	0	0	0	1	0	1	1	1	1
	↓	GS62	0	0	0	0	0	0	0	0	0	0	0	0	0	1	1	1	1	1
	Bleu	GS63	0	0	0	0	0	0	0	0	0	0	0	0	1	1	1	1	1	1

0 : Low level voltage 1 : High level voltage

Each basic color can be displayed in 64 gray scales from 6 bit data signals. According to the combination of total 18 bit data signals, the 262,144-color display can be achieved on the screen.

(9)Optical characteristics

9-1) Not driving the Back light condition

Table 9 Ta=25°C

Parameter	Symbol	Condition	Min	Typ	Max	Unit	Remarks
Viewing angle range	θ _{21,22}	CR ≥ 1.2	30	40	-	degree	[Note 9-1,2]
	θ _{11, 12}		30	40	-	degree	
Contrast ratio	CR _{max}	θ = 0°	-	2	-		[Note 9-2,4]
Response time	Rise	θ = 0°	-	10	20	ms	[Note 9-3]
	Fall		-	10	20	ms	
White chromaticity	x	θ = 0°	0.25	0.30	0.35		[Note 9-4]
	y		0.30	0.35	0.40		
Reflection ratio	R	θ = 0°	2	4	-	%	[Note 9-5]

* The measuring method of the optical characteristics is shown by the following figure.

* A measurement device is Otsuka luminance meter LCD5200.(With the diffusion reflection unit.)

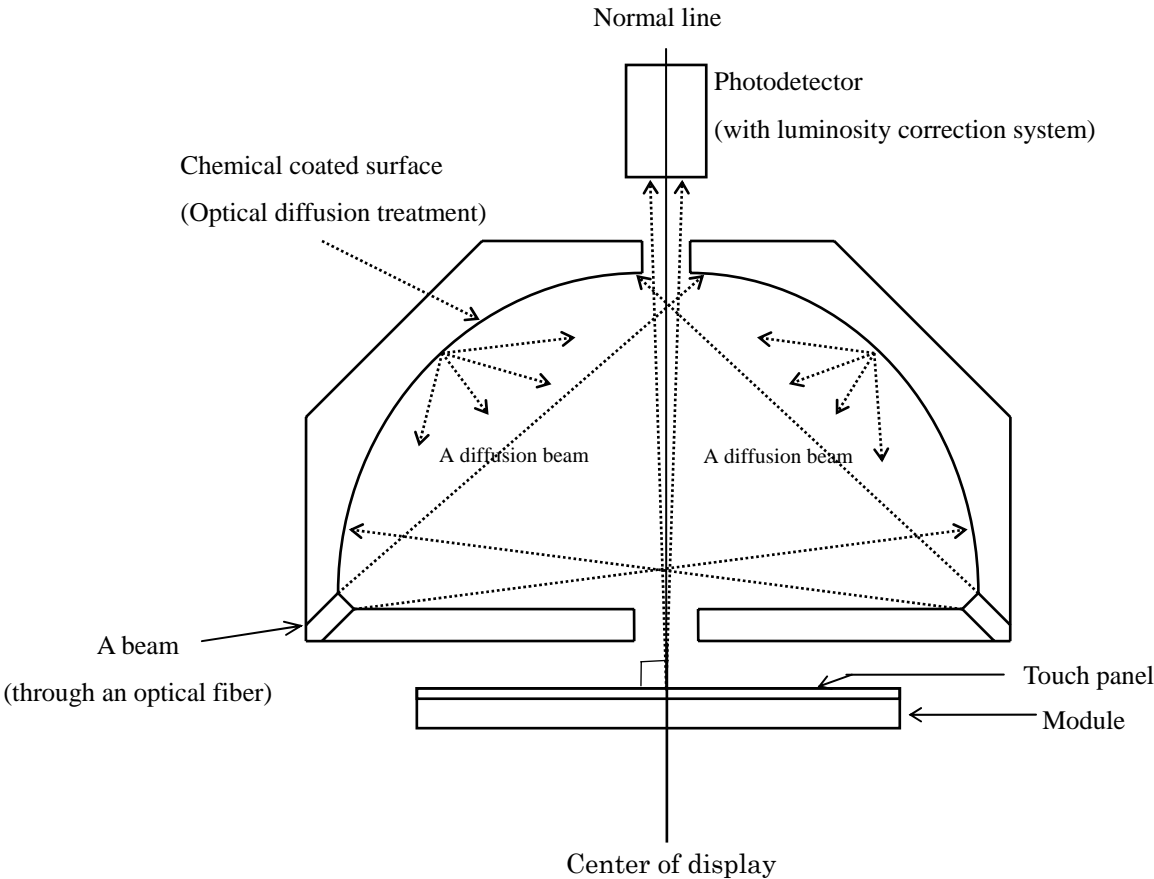

Measuring method (a) for optical characteristics

9-2) Driving the Back light condition

Table 10

Ta=25°C

Parameter		Symbol	Condition	Min	Typ	Max	Unit	Remarks
Viewing angle range		$\theta_{21,22}$	$CR \geq 5$	40	80	-	degree	[Note 9-1,2,6]
		$\theta_{11,12}$		40	80	-	degree	
Contrast ratio		Crmax	$\theta = 0^\circ$	100	200	-		[Note 9-2]
Response time	Rise	τr		-	15	20	ms	[Note 9-3]
	Fall	τd		-	20	30	ms	
White chromaticity		x		0.26	0.31	0.36		
		y	0.28	0.33	0.38			
NTSC ratio		S	-	35	-	%		
Brightness		Y	$\theta = 0^\circ$	110	165	-	cd/m ²	I _L =16mA
Uniformity		U	$\theta = 0^\circ$	60	-	-	%	[Note 9-7]

* The measuring method of the optical characteristics is shown by the following figure.

* A measurement device is TOPCON luminance meter SR-3.(Viewing cone 1)

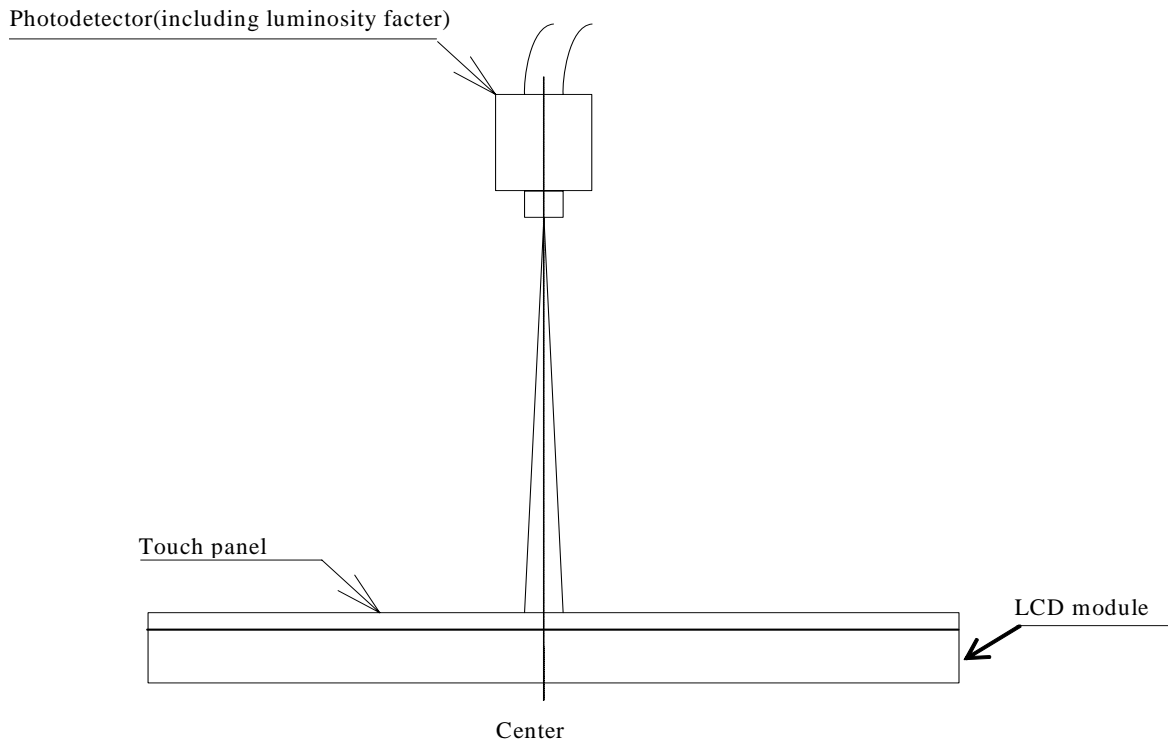

【Measuring method for optical characteristics】

【Note 9-1】 Viewing angle range is defined as follows.

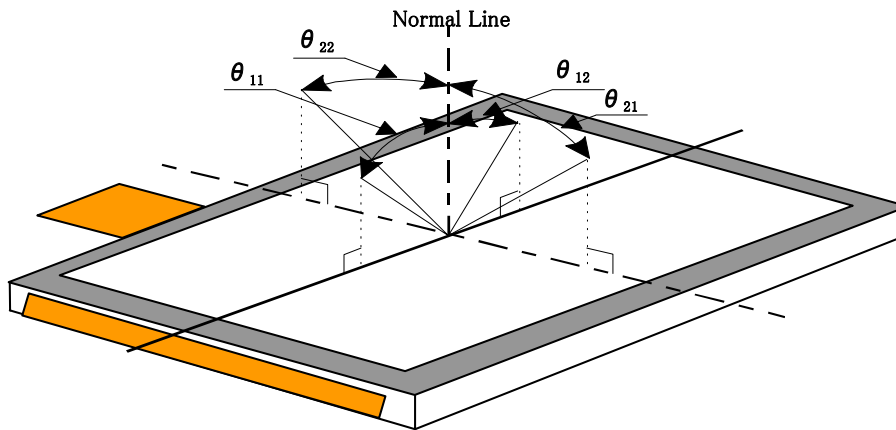

【Definition for viewing angle】

【Note 9-2】 Definition of contrast ratio:

The contrast ratio is defined as follows:

$$\text{Contrast ratio(CR)} = \frac{\text{Photodetector output with all pixels white(GS63)}}{\text{Photodetector output with all pixels black(GS0)}}$$

$$V_{\text{COMAC}}=5.0V_{\text{p-p}}$$

【Note 9-3】 Definition of response time:

The response time is defined as the following figure and shall be measured by switching the input signal for "black" and "white".

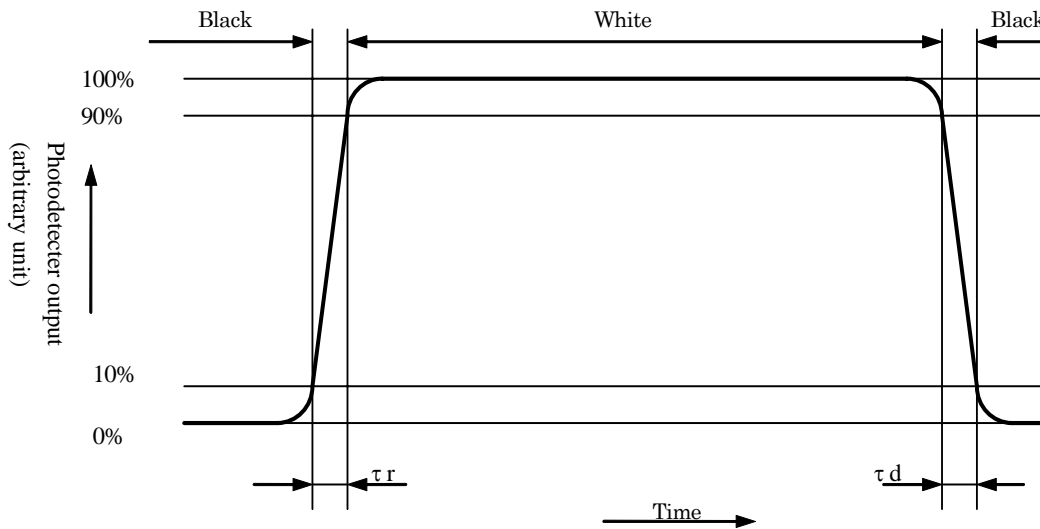

【Note 9-4】 A measurement device is Minolta CM-2002.

【Note 9-5】 Definition of reflection ratio

$$\text{Reflection ratio} = \frac{\text{Light detected level of the reflection by the LCD module}}{\text{Light detected level of the reflection by the standard white board}}$$

【Note 9-6】 A measurement device is ELDIM EZContrast

【Note 9-7】 Definition of Uniformity

$$\text{Uniformity} = \frac{\text{Minimum Brightness}}{\text{Maximum Brightness}} \times 100(\%)$$

The brightness should be measured on the 9-point as shown in the right figure.

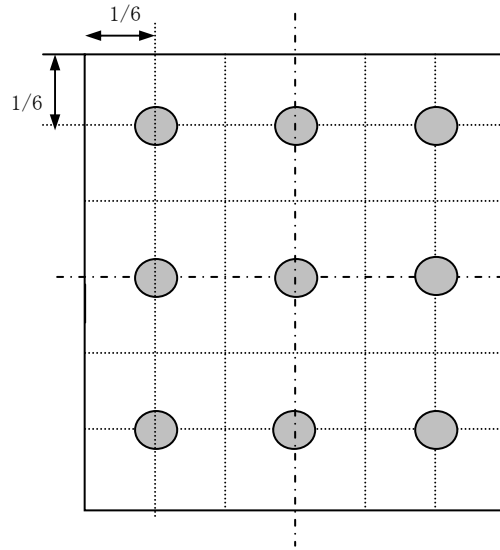

(10) Display quality

The display quality of the color TFT-LCD module shall be in compliance with the Incoming Inspection Standards TFT-LCD.

(11) Touch panel characteristics

Table 11

Parameter	Min.	Typ.	Max.	Unit	Remark
Input voltage	-	5.0	7.0	V	
Resistor between terminals(X1-X2)	200	-	650	Ω	
Resistor between terminals(Y1-Y2)	200	-	640	Ω	
Line linearity(X direction)	-	-	±1.5	%	
Line linearity(Y direction)	-	-	±1.5	%	
Insuration resistance	20	-	-	MΩ	DC25V 1min
Minimum tension for detecting	-	-	0.79	N	

(12) Mechanical characteristics

12-1) External appearance

See Fig. 1 Outline Dimension

12-2) FPC (for LCD panel) characteristics

Specific connector

LCD-FPC : HIROSE FH23-51S-0.3SHAW(05) (Bottom contact only)

(13) Design guidance for touchpanel(T/P)

(1) If a consumer will put a palm on housing in normal usage, care should be taken as follows.

(2) Keep the gap, for example 0.3 to 0.7mm, between bezel edge and T/P surface.

The reason is to avoid the bezel edge from contacting T/P surface that may cause a "short" with bottom layer (See Fig.2)

(3) Insertion of a cushion material is recommended.

(4) The cushion material should be limited just on the busbar insulation paste area.

If it is over the transparent insulation paste area, a "short" may be occurred.

(5) There is one where a resistance film is left in the T/P part of the end of the pole.

Design to keep insulation from the perimeter to prevent from mis-operation and so on.

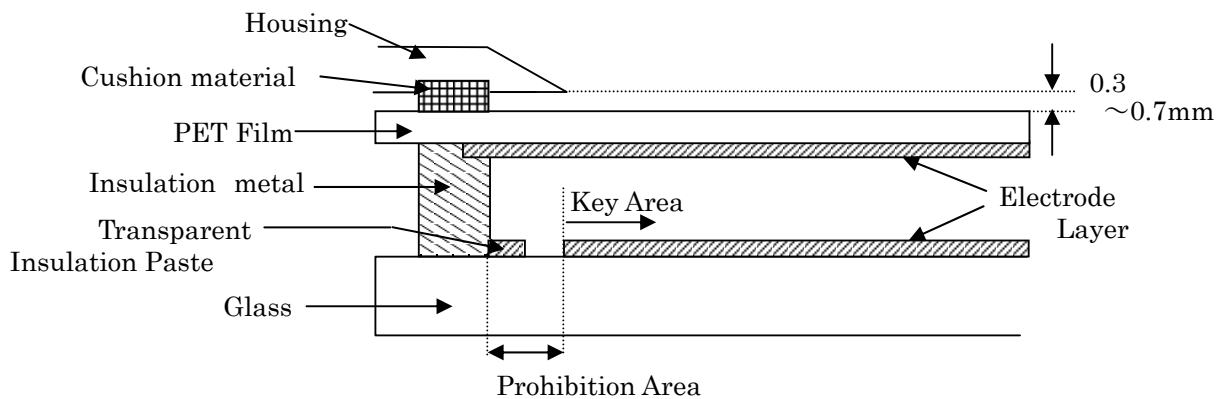

Fig.2

(14) Handling Precautions

14-1) Insertion and taking out of FPCs

- (1) Be sure insert and take out of the FPC into the connector of the set after turning off the power supply on the set side.

14-2) Handling of FPCs

- (1) The FPC for LCD panel shall be bent only slit portion. The bending slit shall be bent uniformly on the whole slit portion with bending radius larger than 1.0mm ,and only inner side (back side of the module). Don't bend it outer side (display surface side).
- (2) Don't give the FPCs too large force, for example, hanging the module with holding FPC. Moreover, Do not put stress on the components mounted on FPC to avoid failure of the components.

14-3) Installation of the module

- (1) On mounting the module, be sure to fix the module on the same plane. Taking care not to warp or twist the module.

14-4) Precaution when mounting

- (1) If water droplets and oil attaches to it for a long time, discoloration and staining occurs. Wipe them off immediately.
- (2) Glass is used for the TFT-LCD panel or touch panel. If it is dropped or bumped against a hard object, it may be broken. Handle it with sufficient care.
- (3) As the CMOS IC is used in this module, pay attention to static electricity when handling it. Take a measure for grounding on the human body.

14-5) Others

- (1) The liquid-crystal is deteriorated by ultraviolet rays. Do not leave it in direct sunlight and strong ultraviolet rays for many hours.
- (2) If it is kept at a temperature below the rated storage temperature, it becomes coagulated and the panel may be broken. Also, if it is kept at a temperature above the rated storage temperature, it becomes isotropic liquid and does not return to its original state. Therefore, it is desirable to keep it at room temperature as much as possible.
- (3) If the LCD breaks, don't put internal liquid crystal into the mouth. When the liquid crystal sticks to the hands, feet and clothes, wash it out immediately.
- (4) Wipe off water drop or finger grease immediately. Long contact with water may cause discoloration or spots.
- (5) Observe general precautions for all electronic components.
- (6) Static image should not be displayed more than 5 minutes in order to prevent from occurrence of residual image.

(15)Reliability Test Conditions for TFT-LCD Module

Table 12

No.	Test items	Test conditions
1	High temperature storage test	Ta=+70°C 240h
2	Low temperature storage test	Ta=-20°C 240h
3	High temperature and high humidity operating test	Tp=+40°C , 95%RH 240h (But no condensation of dew)
4	High temperature operating test	Tp=+60°C 240h
5	Low temperature operating test	Tp=-10°C 240h
6	Electro static discharge test	±200V · 200pF(0Ω) to Terminals(Contact) (1 time for each terminals)
7	Shock tset	980 m/s ² , 6 ms ±X,±Y,±Z 3 times for each direction (JIS C0041, A-7 Condition C)
8	Vibration test	Frequency range: 10Hz~55~10Hz Stroke: 1.5 mm Sweep: 10Hz~55Hz X,Y,Z 2 hours for each direction (total 6 hours) (JIS C0040,A-10 Condition A)
9	Heat shock test	Ta=-20°C~+70°C / 5 cycles (1h) (1h)
10	Point activation test (Touch panel)	Hit it 1,000,000 times with a silicon rubber of R8 HS 60. Hitting force :2.45N(250gf) Hitting speed : 3 times per second
11	Writing friction resistance test (Touch panel)	Slide Pen 100,000 times under following conditions: Pen : 0.8Rmm Polyacetal stylus Load : 2.45N(250gf) Speed : 3 strokes per second Stroke : 35mm Testing apparatus : shown in Fig.3

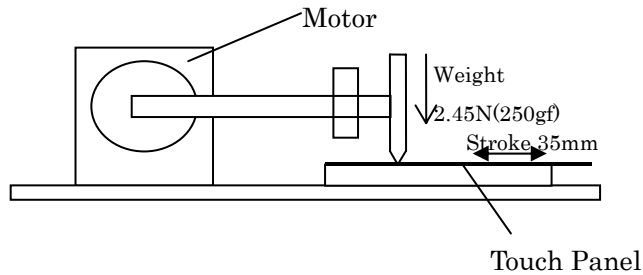

Fig.3

【Note】 Ta = Ambient temperature, Tp = Panel temperature

【Check items】

- Test No.1~9

In the standard condition, there shall be no practical problems that may affect the display function.

- Test No.10~No.11

The measurements after the tests are satisfied (11)-Table 11 (Touch panel characteristics)

(16) Others

16-1) Indication of lot number

The lot number is shown on a label. Attached location is shown in Fig.1 (Outline Dimensions).

16-2) Used Regulation of Chemical Substances Breaking Ozone Stratum

Substances with the object of regulating: CFCS, Carbon tetrachloride, Halon

1,1,1-Trichloro ethane (Methyl chloroform)

- (a) This LCD module, Constructed part and Parts don't contain the above substances.
- (b) This LCD module, Constructed part and Parts don't contain the above substances in processes of manufacture.

16-3) If some problems arise about mentioned items in this document and other items, the user of the TFT-LCD module and Sharp will cooperate and make efforts to solve the problems with mutual respect and good will.

(17) Forwarding form (fig4)

- a) Piling number of cartons : 8
- b) Package quality in one cartons : 100 pcs
- c) Carton size : 575 mm × 360 mm × 225 mm
- d) Total mass of 1 carton filled with full modules : 8,600 g

Conditions for storage

Environment

- (1) Temperature : 0~40°C
- (2) Humidity : 60%RH or less (at 40°C)
No dew condensation at low temperature and high humidity.
- (3) Atmosphere : Harmful gas, such as acid or alkali which bites electronic components and/or wires, must not be detected.
- (4) Period : about 3 months
- (5) Opening of the package : In order to prevent the LCD module from breakdown by electrostatic charges, please control the room humidity over 50%RH and open the package taking sufficient countermeasures against electrostatic charges, such as earth, etc.

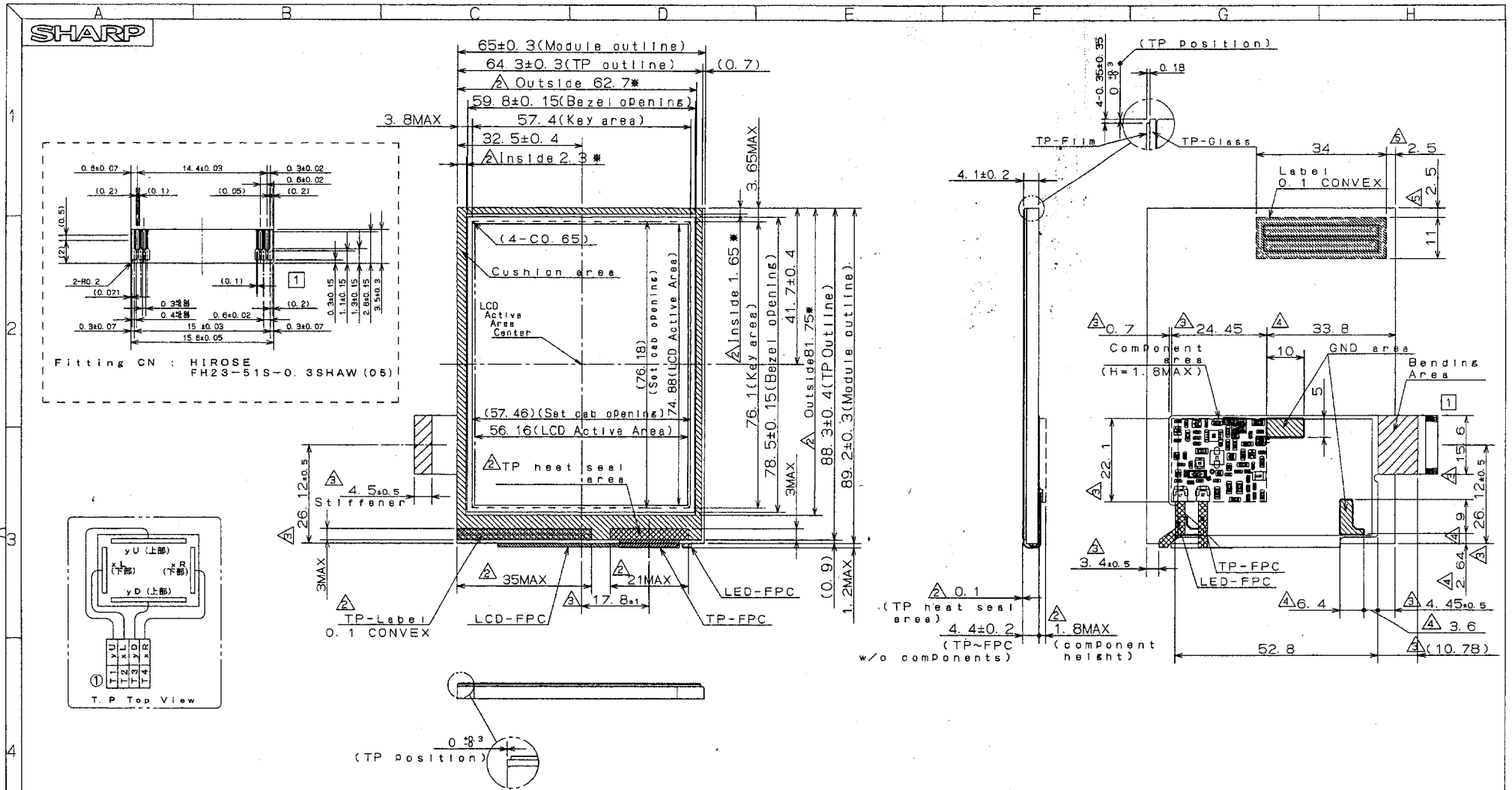

△.LCD-FPC bend radius: Min. 0.6mm
 -Guarantee of appearance = LCD Active Area
 -General tolerance is ± 0.5 mm
 -Take care in set design to hide the scratches and bubbles appeared on the polarizer or other frame area which is located outside of guarantee area.
 -The light of Back Light is leaking from BM outside, please light shielding by the set.
 -The tolerance of module width are exclude warp of case and FPC.
 * Cushion material should be limited to the shaded area.
 When cab-cushion is applied other than the shaded area, it may cause malfunction and influenced the reliability.

Fig. 1 Outline dimensions

2005.06.22.	Item addition.	Y. T.	ORIGINAL MODEL	LS037V7DW01
2005.04.27.	Item addition.	Y. T.	画面サイズ ACTIVE AREA SIZE	93.6(3.69") 0.117mm 480RGBx640
2005.03.30.	Item addition.	Y. T.	尺度 SCALE	1/1
2005.03.01.	Item addition.	Y. T.	日付 DATE	2004.11.10
2004.11.15.	LCD-FPC 45Pin → 51Pin	Y. T.	名称 NAME	3.7" Module Outline dimension
改訂日	改訂記事 REVISION	担当	単位 Unit	mm
設計 DESIGNER	製図 DRAWER	検図 CHK	検図 CHK	承認 ENG. APP.
高尾	松本	松本	計	SHARP CORPORATION
			原紙サイズ A3	図番 LDM-03125F
			DRAWING NO	

LCP-06008A-20

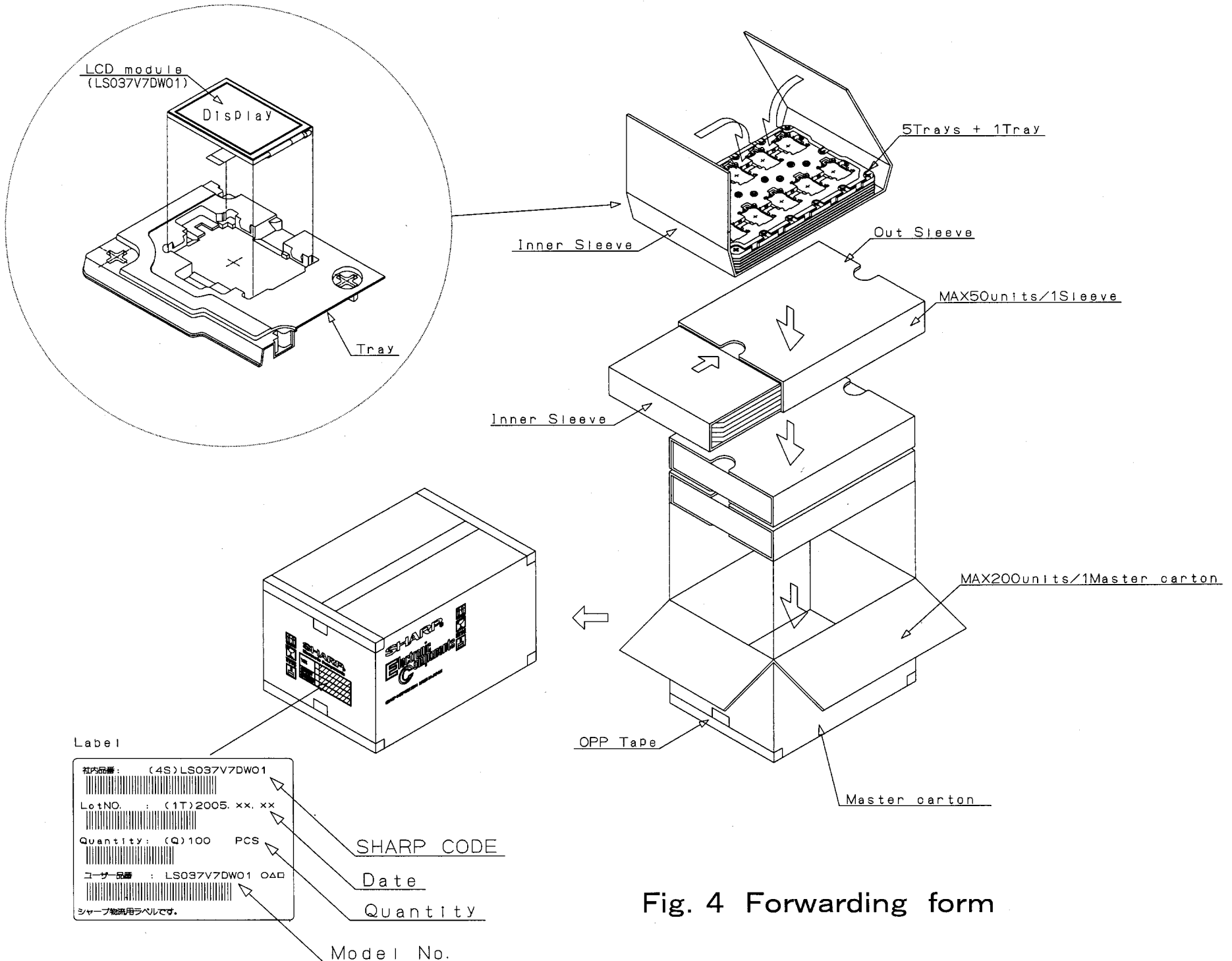

Fig. 4 Forwarding form

NOTICE

This publication is the proprietary of SHARP and is copyrighted, with all rights reserved. Under the copyright laws, no part of this publication may be reproduced or transmitted in any form or by any means, electronic or mechanical for any purpose, in whole or in part, without the express written permission of SHARP. Express written permission is also required before any use of this publication may be made by a third party.

The application circuit examples in this publication are provided to explain the representative applications of SHARP's devices and are not intended to guarantee any circuit design or permit any industrial property right or other rights to be executed. SHARP takes no responsibility for any problems related to any industrial property right or a third party resulting from the use of SHARP's devices, except for those resulting directly from device manufacturing processes.

In the absence of confirmation by device specification sheets, SHARP takes no responsibility for any defects that occur in equipment using any of SHARP's devices, shown in catalogs, data books, etc. Contact SHARP in order to obtain the latest device specification sheets before using any SHARP's device.

SHARP reserves the right to make changes in the specifications, characteristics, data, materials, structures and other contents described herein at any time without notice in order to improve design or reliability. Contact SHARP in order to obtain the latest specification sheets before using any SHARP's device. Manufacturing locations are also subject to change without notice.

Observe the following points when using any device in this publication. SHARP takes no responsibility for damage caused by improper use *of the devices*.

The appropriate design measures should be taken to ensure reliability and safety when SHARP's devices are used for equipment such as:

- Transportation control and safety equipment (i.e., aircraft, trains, automobiles, etc.)
- Traffic signals
- Alarm equipment
- Gas leakage sensor breakers
- Various safety devices etc.

SHARP's devices shall not be used for equipment that requires extremely high level of reliability, such as:

- Military and space applications
- Medical equipment for life support
- Nuclear power control equipment

Contact a SHARP representative, in advance, when intending to use SHARP's devices for any "specific" applications other than those recommended by SHARP.

Contact and consult with a SHARP representative if there are any questions about the contents of this publication.

SPECIFICATIONS ARE SUBJECT TO CHANGE WITHOUT NOTICE.

Suggested applications (if any) are for standard use; See Important Restrictions for limitations on special applications. See Limited Warranty for SHARP's product warranty. The Limited Warranty is in lieu, and exclusive of, all other warranties, express or implied. ALL EXPRESS AND IMPLIED WARRANTIES, INCLUDING THE WARRANTIES OF MERCHANTABILITY, FITNESS FOR USE AND FITNESS FOR A PARTICULAR PURPOSE, ARE SPECIFICALLY EXCLUDED. In no event will SHARP be liable, or in any way responsible, for any incidental or consequential economic or property damage.

SHARP®

NORTH AMERICA

SHARP Microelectronics of the Americas
5700 NW Pacific Rim Blvd.
Camas, WA 98607, U.S.A.
Phone: (1) 360-834-2500
Fax: (1) 360-834-8903
Fast Info: (1) 800-833-9437
www.sharpsma.com

EUROPE

SHARP Microelectronics Europe
Division of Sharp Electronics (Europe) GmbH
Sonninstrasse 3
20097 Hamburg, Germany
Phone: (49) 40-2376-2286
Fax: (49) 40-2376-2232
www.sharpsme.com

JAPAN

SHARP Corporation
Electronic Components & Devices
22-22 Nagaike-cho, Abeno-Ku
Osaka 545-8522, Japan
Phone: (81) 6-6621-1221
Fax: (81) 6117-725300/6117-725301
www.sharp-world.com

TAIWAN

SHARP Electronic Components
(Taiwan) Corporation
8F-A, No. 16, Sec. 4, Nanking E. Rd.
Taipei, Taiwan, Republic of China
Phone: (886) 2-2577-7341
Fax: (886) 2-2577-7326/2-2577-7328

SINGAPORE

SHARP Electronics (Singapore) PTE., Ltd.
438A, Alexandra Road, #05-01/02
Alexandra Technopark,
Singapore 119967
Phone: (65) 271-3566
Fax: (65) 271-3855

KOREA

SHARP Electronic Components
(Korea) Corporation
RM 501 Geosung B/D, 541
Dohwa-dong, Mapo-ku
Seoul 121-701, Korea
Phone: (82) 2-711-5813 ~ 8
Fax: (82) 2-711-5819

CHINA

SHARP Microelectronics of China
(Shanghai) Co., Ltd.
28 Xin Jin Qiao Road King Tower 16F
Pudong Shanghai, 201206 P.R. China
Phone: (86) 21-5854-7710/21-5834-6056
Fax: (86) 21-5854-4340/21-5834-6057

Head Office:

No. 360, Bashen Road,
Xin Development Bldg. 22
Waigaoqiao Free Trade Zone Shanghai
200131 P.R. China
Email: smc@china.global.sharp.co.jp

HONG KONG

SHARP-ROXY (Hong Kong) Ltd.
3rd Business Division,
17/F, Admiralty Centre, Tower 1
18 Harcourt Road, Hong Kong
Phone: (852) 28229311
Fax: (852) 28660779
www.sharp.com.hk

Shenzhen Representative Office:

Room 13B1, Tower C,
Electronics Science & Technology Building
Shen Nan Zhong Road
Shenzhen, P.R. China
Phone: (86) 755-3273731
Fax: (86) 755-3273735