

LED Displays Numeric 7-segment

Single Digit Display 0.3"

PART NO		CHIP		λP (nm)	Vf(v) @ 20mA		Iv(mcd) @ 10mA	
		material	emitted		Min	Max	Min	Typ
LSD3211-XX	C.C	GaP	Red	697	1.7	2.8	1.5	2.5
LSD3212-XX		GaP	Green	565	1.7	2.8	2.2	3.8
LSD3214-XX		GaAsP/GaP	HI-Eff Red	635	1.7	2.8	2.5	4
LSD3215-XX		GaAlAs	Super Red	660	1.5	2.4	5.9	9.8
LSD3213-XX		GaAsP/GaP	Yellow	585	1.5	2.4	2.7	4.5
LSD3221-XX	C.A	GaP	Red	697	1.7	2.8	1.5	2.5
LSD3222-XX		GaP	Green	565	1.7	2.8	2.2	3.8
LSD3224-XX		GaAsP/GaP	HI-Eff Red	635	1.7	2.8	2.5	4
LSD3225-XX		GaAlAs	Red	660	1.7	2.8	5.9	9.8
LSD3223-XX		GaAsP/GaP	Yellow	585	1.5	2.4	2.7	4.5

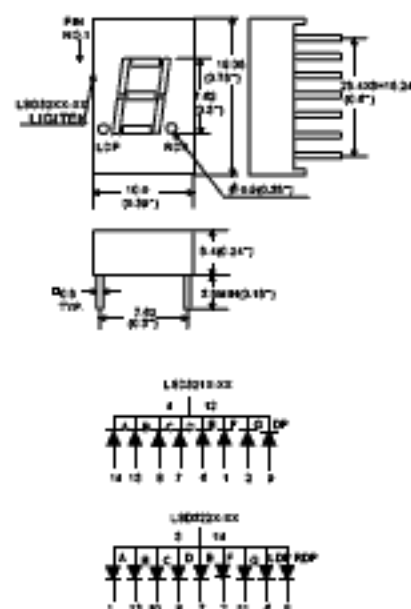

Single Digit Display 0.32"

PART NO		CHIP		λP (nm)	Vf(v) @ 20mA		Iv(mcd) @ 10mA	
		material	emitted		Min	Max	Min	Typ
LSD3C51-XX	C.C	GaP	Red	697	1.7	2.8	1.5	2.5
LSD3C52-XX		GaP	Green	565	1.7	2.8	2.2	3.8
LSD3C54-XX		GaAsP/GaP	HI-Eff Red	635	1.7	2.8	2.5	4
LSD3C55-XX		GaAlAs	Super Red	660	1.5	2.4	3.5	5.5
LSD3C53-XX		GaAsP/GaP	Yellow	585	1.5	2.4	2.5	4
LSD3C61-XX	C.A	GaP	Red	697	1.7	2.8	1.5	2.5
LSD3C62-XX		GaP	Green	565	1.7	2.8	2.2	3.8
LSD3C64-XX		GaAsP/GaP	HI-Eff Red	635	1.7	2.8	2.5	4
LSD3C65-XX		GaAlAs	Red	660	1.7	2.8	3.5	5.5
LSD3C63-XX		GaAsP/GaP	Yellow	585	1.5	2.4	2.5	4

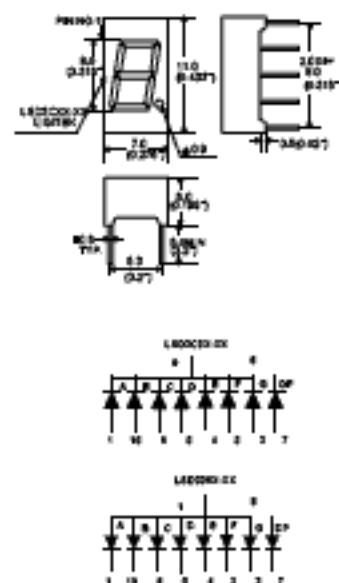

Single Digit Display 0.32"

PART NO		CHIP		λP (nm)	Vf(v) @ 20mA		Iv(mcd) @ 10mA	
		material	emitted		Min	Max	Min	Typ
LSD3351-XX	C.C	GaP	Red	697	1.7	2.8	1.5	2.5
LSD3352-XX		GaP	Green	565	1.7	2.8	2.2	3.8
LSD3354-XX		GaAsP/GaP	HI-Eff Red	635	1.7	2.8	2.5	4
LSD3355-XX		GaAlAs	Super Red	660	1.5	2.4	3.5	5.5
LSD3353-XX		GaAsP/GaP	Yellow	585	1.5	2.4	2.5	4
LSD3361-XX	C.A	GaP	Red	697	1.7	2.8	1.5	2.5
LSD3362-XX		GaP	Green	565	1.7	2.8	2.2	3.8
LSD3364-XX		GaAsP/GaP	HI-Eff Red	635	1.7	2.8	2.5	4
LSD3365-XX		GaAlAs	Red	660	1.7	2.8	3.5	5.5
LSD3363-XX		GaAsP/GaP	Yellow	585	1.5	2.4	2.5	4

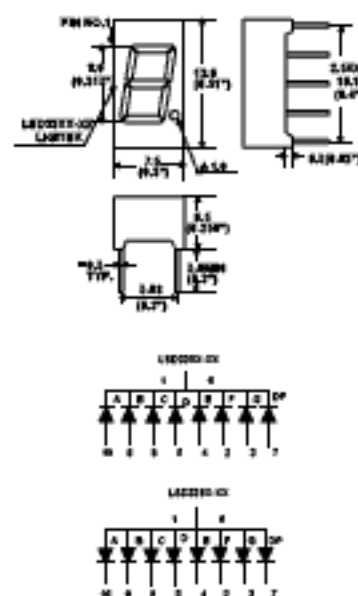

Displays are supplied bin graded and luminous intensity values may be higher in production

.LED Displays Numeric 7-segment

Single Digit Display 0.36"

PART NO		CHIP		λP (nm)	Vf(v) @ 20mA		Iv(mcd) @ 10mA	
		material	emitted		Min	Max	Min	Typ
LSD3151-XX	C.C	GaP	Red	697	1.7	2.8	1.5	2.5
LSD3152-XX		GaP	Green	565	1.7	2.8	2.2	3.8
LSD3154-XX		GaAsP/GaP	HI-Eff Red	635	1.7	2.8	2.5	4
LSD3155-XX		GaAlAs	Super Red	660	1.5	2.4	3.5	5.5
LSD3153-XX		GaAsP/GaP	Yellow	585	1.5	2.4	2.5	4
LSD3161-XX	C.A	GaP	Red	697	1.7	2.8	1.5	2.5
LSD3162-XX		GaP	Green	565	1.7	2.8	2.2	3.8
LSD3164-XX		GaAsP/GaP	HI-Eff Red	635	1.7	2.8	2.5	4
LSD3165-XX		GaAlAs	Red	660	1.7	2.8	3.5	5.5
LSD3163-XX		GaAsP/GaP	Yellow	585	1.5	2.4	2.5	4

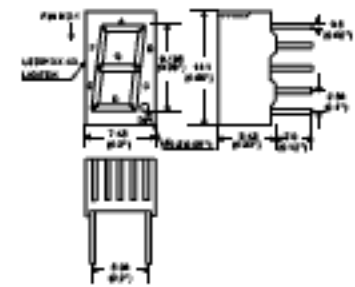

Single Digit Display 0.39"

PART NO		CHIP		λP (nm)	Vf(v) @ 20mA		Iv(mcd) @ 10mA	
		material	emitted		Min	Max	Min	Typ
LSD3551-XX	C.C	GaP	Red	697	1.7	2.8	1.5	2.5
LSD3552-XX		GaP	Green	565	1.7	2.8	2.2	3.8
LSD3554-XX		GaAsP/GaP	HI-Eff Red	635	1.7	2.8	2.5	4
LSD3555-XX		GaAlAs	Super Red	660	1.5	2.4	4	7
LSD3553-XX		GaAsP/GaP	Yellow	585	1.5	2.4	2.5	4
LSD3561-XX	C.A	GaP	Red	697	1.7	2.8	1.5	2.5
LSD3562-XX		GaP	Green	565	1.7	2.8	2.2	3.8
LSD3564-XX		GaAsP/GaP	HI-Eff Red	635	1.7	2.8	2.5	4
LSD3565-XX		GaAlAs	Red	660	1.7	2.8	4	7
LSD3563-XX		GaAsP/GaP	Yellow	585	1.5	2.4	2.5	4

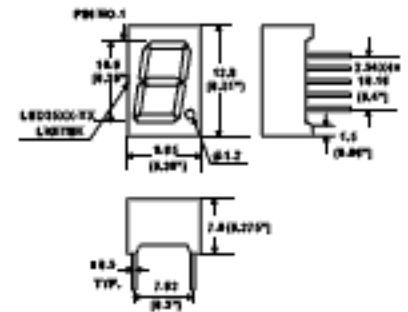

Single Digit Display 0.39"

PART NO		CHIP		λP (nm)	Vf(v) @ 20mA		Iv(mcd) @ 10mA	
		material	emitted		Min	Max	Min	Typ
LSD3751-XX	C.C	GaP	Red	697	1.7	2.8	1.5	2.5
LSD3752-XX		GaP	Green	565	1.7	2.8	2.2	3.8
LSD3754-XX		GaAsP/GaP	HI-Eff Red	635	1.7	2.8	2.5	4
LSD3755-XX		GaAlAs	Super Red	660	1.5	2.4	4	7
LSD3753-XX		GaAsP/GaP	Yellow	585	1.5	2.4	2.5	4
LSD3761-XX	C.A	GaP	Red	697	1.7	2.8	1.5	2.5
LSD3762-XX		GaP	Green	565	1.7	2.8	2.2	3.8
LSD3764-XX		GaAsP/GaP	HI-Eff Red	635	1.7	2.8	2.5	4
LSD3765-XX		GaAlAs	Red	660	1.7	2.8	4	7
LSD3763-XX		GaAsP/GaP	Yellow	585	1.5	2.4	2.5	4

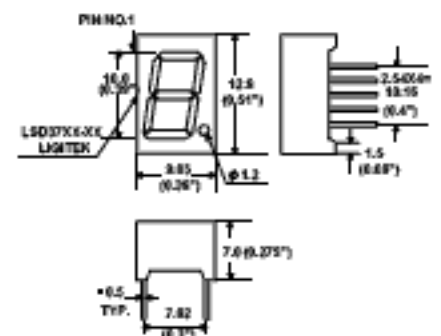

Displays are supplied bin graded and luminous intensity values may be higher in production

LED Displays Numeric 7-segment

Single Digit Display 0.43"

PART NO		CHIP		λP (nm)	Vf(v) @ 20mA		Iv(mcd) @ 10mA	
		material	emitted		Min	Max	Min	Typ
LSD4311-XX	C.C	GaP	Red	697	1.7	2.8	0.5	0.9
LSD4312-XX		GaP	Green	565	1.7	2.8	1.5	2.8
LSD4314-XX		GaAsP/GaP	Hi-Eff Red	635	1.7	2.8	1.8	3
LSD4315-XX		GaAlAs	Super Red	660	1.5	2.4	3	5.5
LSD4313-XX		GaAsP/GaP	Yellow	585	1.5	2.4	1.8	3
LSD4321-XX	C.A	GaP	Red	697	1.7	2.8	0.5	0.9
LSD4322-XX		GaP	Green	565	1.7	2.8	1.5	2.8
LSD4324-XX		GaAsP/GaP	Hi-Eff Red	635	1.7	2.8	1.8	3
LSD4325-XX		GaAlAs	Red	660	1.7	2.8	3	5.5
LSD4323-XX		GaAsP/GaP	Yellow	585	1.5	2.4	1.8	3

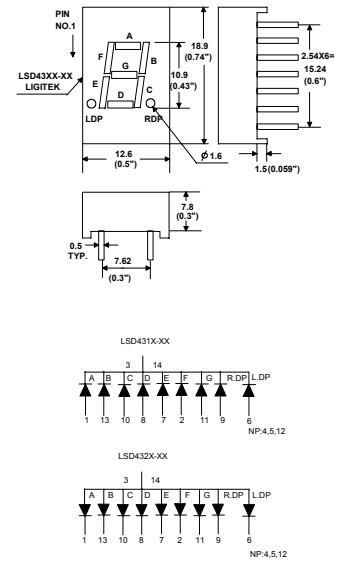

Single Digit Display 0.50"

PART NO		CHIP		λP (nm)	Vf(v) @ 20mA		Iv(mcd) @ 10mA	
		material	emitted		Min	Max	Min	Typ
LSD5051-XX	C.C	GaP	Red	697	1.7	2.8	0.9	1.5
LSD5052-XX		GaP	Green	565	1.7	2.8	1.6	2.6
LSD5054-XX		GaAsP/GaP	Hi-Eff Red	635	1.7	2.8	1.8	3.2
LSD5055-XX		GaAlAs	Super Red	660	1.5	2.4	3.5	6
LSD5053-XX		GaAsP/GaP	Yellow	585	1.5	2.4	1.8	3.2
LSD5061-XX	C.A	GaP	Red	697	1.7	2.8	0.9	1.5
LSD5062-XX		GaP	Green	565	1.7	2.8	1.6	2.6
LSD5064-XX		GaAsP/GaP	Hi-Eff Red	635	1.7	2.8	1.8	3.2
LSD5065-XX		GaAlAs	Red	660	1.7	2.8	3.5	6
LSD5063-XX		GaAsP/GaP	Yellow	585	1.5	2.4	1.8	3.2

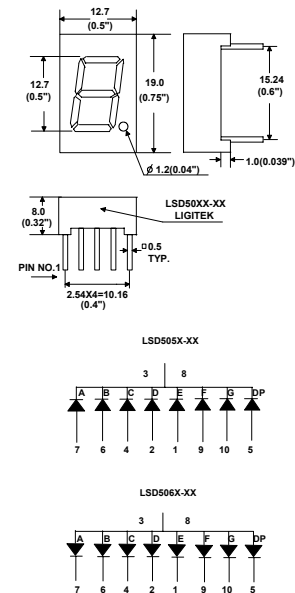

Single Digit Display 0.52"

PART NO		CHIP		λP (nm)	Vf(v) @ 20mA		Iv(mcd) @ 10mA	
		material	emitted		Min	Max	Min	Typ
LSD5351-XX	C.C	GaP	Red	697	1.7	2.8	0.9	1.5
LSD5352-XX		GaP	Green	565	1.7	2.8	2.4	4
LSD5354-XX		GaAsP/GaP	Hi-Eff Red	635	1.7	2.8	3	4.5
LSD5355-XX		GaAlAs	Super Red	660	1.5	2.4	5	8.5
LSD5353-XX		GaAsP/GaP	Yellow	585	1.5	2.4	3	4.5
LSD5361-XX	C.A	GaP	Red	697	1.7	2.8	0.9	1.5
LSD5362-XX		GaP	Green	565	1.7	2.8	2.4	4
LSD5364-XX		GaAsP/GaP	Hi-Eff Red	635	1.7	2.8	3	4.5
LSD5365-XX		GaAlAs	Red	660	1.7	2.8	5	8.5
LSD5363-XX		GaAsP/GaP	Yellow	585	1.5	2.4	3	4.5

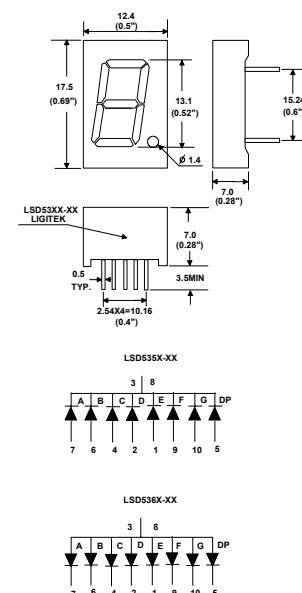

Displays are supplied bin graded and luminous intensity values may be higher in production.

LED Displays Numeric 7-segment

Single Digit Display 0.56"

PART NO		CHIP		λP (nm)	Vf(v) @ 20mA		Iv(mcd) @ 10mA	
		material	emitted		Min	Max	Min	Typ
LSD5111-XX	C.C	GaP	Red	697	1.7	2.8	0.9	1.5
LSD5112-XX		GaP	Green	565	1.7	2.8	2.5	4.5
LSD5114-XX		GaAsP/GaP	Hi-Eff Red	635	1.7	2.8	3	4.5
LSD5115-XX		GaAlAs	Super Red	660	1.5	2.4	4.5	6.5
LSD5113-XX		GaAsP/GaP	Yellow	585	1.5	2.4	3	4.5
LSD5121-XX	C.A	GaP	Red	697	1.7	2.8	0.9	1.5
LSD5122-XX		GaP	Green	565	1.7	2.8	2.5	4.5
LSD5124-XX		GaAsP/GaP	Hi-Eff Red	635	1.7	2.8	3	4.5
LSD5125-XX		GaAlAs	Red	660	1.7	2.8	4.5	6.5
LSD5123-XX		GaAsP/GaP	Yellow	585	1.5	2.4	3	4.5

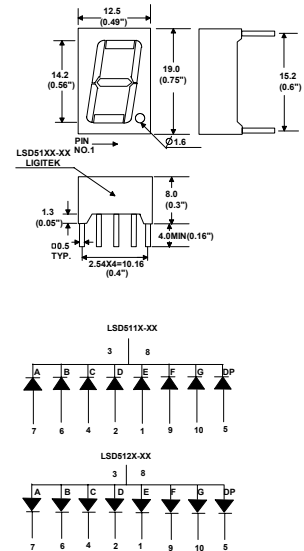

Single Digit Display 0.8"

PART NO		CHIP		λP (nm)	Vf(v) @ 20mA		Iv(mcd) @ 10mA	
		material	emitted		Min	Max	Min	Typ
LSD8151-XX	C.C	GaP	Red	697	1.7	2.8	0.9	1.5
LSD8152-XX		GaP	Green	565	1.7	2.8	2.5	4.5
LSD8154-XX		GaAsP/GaP	Hi-Eff Red	635	1.7	2.8	3	4.5
LSD8155-XX		GaAlAs	Super Red	660	1.5	2.4	6	10
LSD8153-XX		GaAsP/GaP	Yellow	585	1.5	2.4	3	4.5
LSD8161-XX	C.A	GaP	Red	697	1.7	2.8	0.9	1.5
LSD8162-XX		GaP	Green	565	1.7	2.8	2.5	4.5
LSD8164-XX		GaAsP/GaP	Hi-Eff Red	635	1.7	2.8	3	4.5
LSD8165-XX		GaAlAs	Red	660	1.7	2.8	6	10
LSD8163-XX		GaAsP/GaP	Yellow	585	1.5	2.4	3	4.5

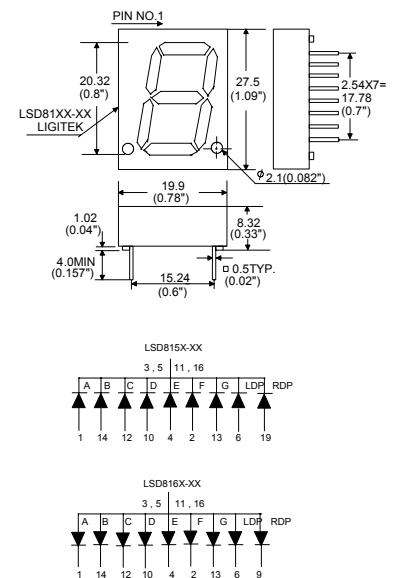

Single Digit Display 1.0"

PART NO		CHIP		λP (nm)	Vf(v) @ 20mA		Iv(mcd) @ 10mA	
		material	emitted		Min	Max	Min	Typ
LSD10051-XX	C.C	GaP	Red	697	1.7	2.8	1.5	2.5
LSD10052-XX		GaP	Green	565	1.7	2.8	5	8
LSD10054-XX		GaAsP/GaP	Hi-Eff Red	635	1.7	2.8	6	10
LSD10055-XX		GaAlAs	Super Red	660	1.5	2.4	10	18
LSD10053-XX		GaAsP/GaP	Yellow	585	1.5	2.4	6	10
LSD10061-XX	C.A	GaP	Red	697	1.7	2.8	1.5	2.5
LSD10062-XX		GaP	Green	565	1.7	2.8	5	8
LSD10064-XX		GaAsP/GaP	Hi-Eff Red	635	1.7	2.8	6	10
LSD10065-XX		GaAlAs	Red	660	1.7	2.8	10	18
LSD10063-XX		GaAsP/GaP	Yellow	585	1.5	2.4	6	10

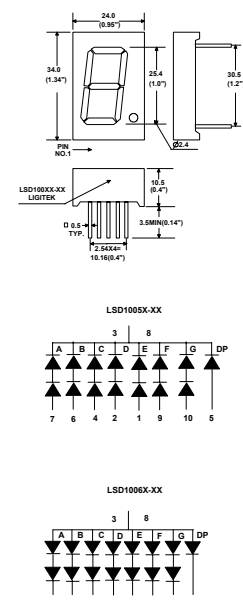

Displays are supplied bin graded and luminous intensity values may be higher in production.

LED Displays Numeric 7-segment

Single Digit Display 1.5"

PART NO		CHIP		λP (nm)	Vf(v) @ 20mA		Iv(mcd) @ 10mA	
		material	emitted		Min	Max	Min	Typ
LSD15051-XX	C.C	GaP	Red	697	1.7	2.8	1.5	2.5
LSD15052-XX		GaP	Green	565	1.7	2.8	5	8
LSD15054-XX		GaAsP/GaP	Hi-Eff Red	635	1.7	2.8	6	10
LSD15055-XX		GaAlAs	Super Red	660	1.5	2.4	10	18
LSD15053-XX		GaAsP/GaP	Yellow	585	1.7	2.8	6	10
LSD15061-XX	C.A	GaP	Red	697	1.7	2.8	1.5	2.5
LSD15062-XX		GaP	Green	565	1.7	2.8	5	8
LSD15064-XX		GaAsP/GaP	Hi-Eff Red	635	1.7	2.8	6	10
LSD15065-XX		GaAlAs	Red	660	1.7	2.8	10	18
LSD15063-XX		GaAsP/GaP	Yellow	585	1.7	2.8	6	10

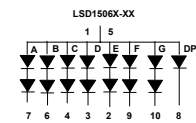
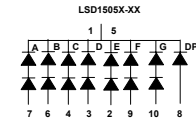
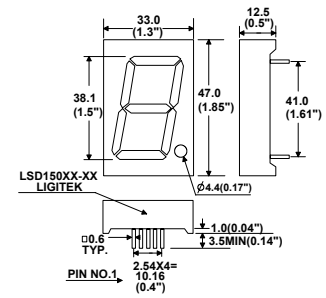

Single Digit Display 1.8"

PART NO		CHIP		λP (nm)	Vf(v) @ 20mA		Iv(mcd) @ 10mA	
		material	emitted		Min	Max	Min	Typ
LSD18051-XX	C.C	GaP	Red	697	1.7	2.8	2.5	4
LSD18052-XX		GaP	Green	565	1.7	2.8	7	12
LSD18054-XX		GaAsP/GaP	Hi-Eff Red	635	1.7	2.8	9	15
LSD18055-XX		GaAlAs	Super Red	660	1.5	2.4	12	20
LSD18053-XX		GaAsP/GaP	Yellow	585	1.7	2.8	9	15
LSD18061-XX	C.A	GaP	Red	697	1.7	2.8	2.5	4
LSD18062-XX		GaP	Green	565	1.7	2.8	7	12
LSD18064-XX		GaAsP/GaP	Hi-Eff Red	635	1.7	2.8	9	15
LSD18065-XX		GaAlAs	Red	660	1.7	2.8	12	20
LSD18063-XX		GaAsP/GaP	Yellow	585	1.7	2.8	9	15

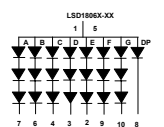
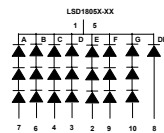
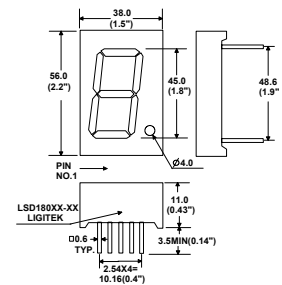

Single Digit Display 2.3"

PART NO		CHIP		λP (nm)	Vf(v) @ 20mA		Iv(mcd) @ 10mA	
		material	emitted		Min	Max	Min	Typ
LSD23251-XX	C.C	GaP	Red	697	1.7	2.8	4.8	8
LSD23252-XX		GaP	Green	565	1.7	2.8	10	18
LSD23254-XX		GaAsP/GaP	Hi-Eff Red	635	1.7	2.8	10	18
LSD23255-XX		GaAlAs	Super Red	660	1.5	2.4	18	30
LSD23253-XX		GaAsP/GaP	Yellow	585	1.7	2.8	10	18
LSD23261-XX	C.A	GaP	Red	697	1.7	2.8	4.8	8
LSD23262-XX		GaP	Green	565	1.7	2.8	10	18
LSD23264-XX		GaAsP/GaP	Hi-Eff Red	635	1.7	2.8	10	18
LSD23265-XX		GaAlAs	Red	660	1.7	2.8	18	30
LSD23263-XX		GaAsP/GaP	Yellow	585	1.7	2.8	10	18

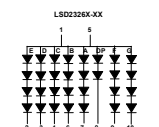
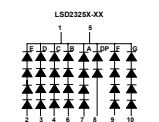
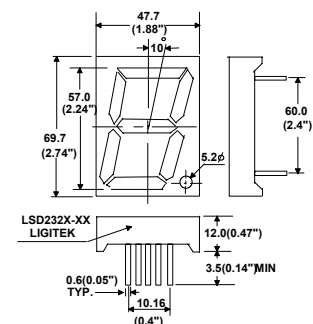

Displays are supplied bin graded and luminous intensity values may be higher in production.

LED Displays Numeric 7-segment

Single Digit Display 4.0"

PART NO		CHIP		λP (nm)	Vf(v) @ 20mA		Iv(mcd) @ 10mA	
		material	emitted		Min	Max	Min	Typ
LSD40152-XX	C.C	GaP	Green	565	6.8	11.2	12.8	21.5
LSD40154-XX		GaAsP/GaP	Hi-Eff Red	635	6.8	11.2	12.8	21.5
LSD40155-XX		GaAlAs	Super Red	660	6	9.6	18	31
LSD40156-XX		GaAlAs	Ultra Red	660	6	9.6	26	43
LSD40153-XX		GaAsP/GaP	Yellow	585	6.8	11.2	12.8	21.5
LSD40162-XX	C.A	GaP	Green	565	6.8	11.2	12.8	21.5
LSD40164-XX		GaAsP/GaP	Hi-Eff Red	635	6.8	11.2	12.8	21.5
LSD40165-XX		GaAlAs	Super Red	660	6	9.6	18	31
LSD40166-XX		GaAlAs	Ultra Red	660	6	9.6	26	43
LSD40163-XX		GaAsP/GaP	Yellow	585	6.8	11.2	12.8	21.5

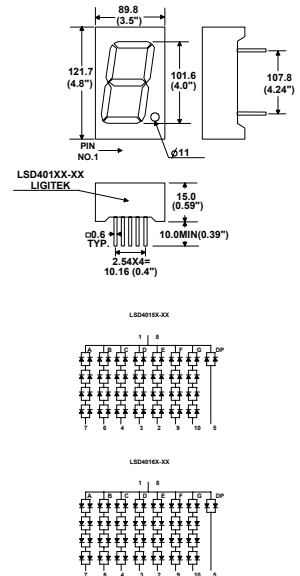

Single Digit Display 4.0"

PART NO		CHIP		λP (nm)	Vf(v) @ 20mA		Iv(mcd) @ 10mA	
		material	emitted		Min	Max	Min	Typ
LSD40051-XX	C.C	GaP	Red	697	8.5	14	4.8	8
LSD40052-XX		GaP	Green	565	8.5	14	10	18
LSD40054-XX		GaAsP/GaP	Hi-Eff Red	635	8.5	14	10	18
LSD40055-XX		GaAlAs	Super Red	660	7.5	12	18	30
LSD40053-XX		GaAsP/GaP	Yellow	585	8.5	14	10	18
LSD40061-XX	C.A	GaP	Red	697	8.5	14	4.8	8
LSD40062-XX		GaP	Green	565	8.5	14	10	18
LSD40064-XX		GaAsP/GaP	Hi-Eff Red	635	8.5	14	10	18
LSD40065-XX		GaAlAs	Red	660	7.5	12	18	30
LSD40063-XX		GaAsP/GaP	Yellow	585	8.5	14	10	18

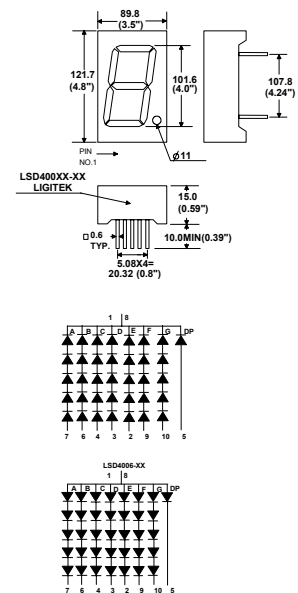

Single Digit Display 5.0"

PART NO		CHIP		λP (nm)	Vf(v) @ 20mA		Iv(mcd) @ 10mA	
		material	emitted		Min	Max	Min	Typ
LSD50152-XX	C.C	GaP	Green	565	17	28	39	65
LSD50154-XX		GaAsP/GaP	Hi-Eff Red	635	17	28	39	65
LSD50155-XX		GaAlAs	Super Red	660	15	24	50	85
LSD50156-XX		GaAlAs	Ultra Red	660	15	24	100	170
LSD50153-XX		GaAsP/GaP	Yellow	585	17	28	39	65
LSD50162-XX	C.A	GaP	Green	565	17	28	39	65
LSD50164-XX		GaAsP/GaP	Hi-Eff Red	635	17	28	39	65
LSD50165-XX		GaAlAs	Super Red	660	15	24	50	85
LSD50166-XX		GaAlAs	Ultra Red	660	15	24	100	170
LSD50163-XX		GaAsP/GaP	Yellow	585	17	28	39	65

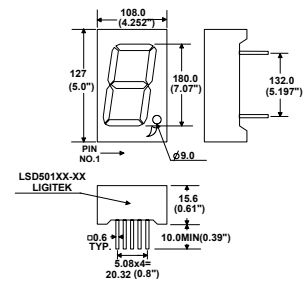

Displays are supplied bin graded and luminous intensity values may be higher in production.

LED Displays Numeric 7-segment

Single Digit Display 8.7"

PART NO		CHIP		λ_P (nm)	Vf(v) @ 20mA		Iv(mcd) @ 10mA	
		material	emitted		Min	Max	Min	Typ
LSD80057-XX	C.C	GaAlAs	Super Red	660	7.5	12	50	85
LSD80058-XX	C.C	AlInGaP	Yellow	595	8.5	14	50	85
LSD80067-XX	C.A.	GaAlAs	Super Red	660	7.5	12	50	85
LSD80068-XX	C.A.	AlInGaP	Yellow	595	8.5	14	50	85

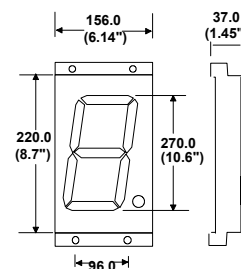

Single Digit Display 12.0"

PART NO		CHIP		λ_P (nm)	Vf(v) @ 20mA		Iv(mcd) @ 10mA		
		material	emitted		Min	Max	Min	Typ	
LSD12001SRA	C.A.	GaAlAs	Super Red	660	28.5	33	1,600	2,000	
LSD12001SRA		GaAlAs	Ultra Red	660	28.5	33	2,600	3,400	

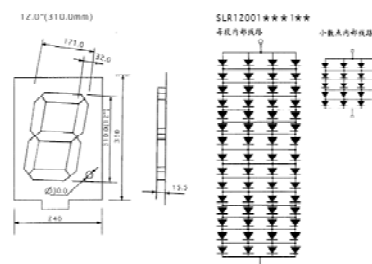

Displays are supplied bin graded and luminous intensity values may be higher in production.

Notes: Display face and segment colours are denoted in the suffix **xx**

Reflector Surface

- 0 Original
- 1 Black
- 2 Grey
- 3 Red
- 4 Orange

Segment Colour

- 0 White Diffused
- 1 Red Diffused
- 2 Green Diffused
- 3 Yellow Diffused
- 4 Orange Diffused

Low current options are available add suffix T2

Additional colours and multi-colour versions may also be specified. M.O.Q.'s may apply

See additional data sheet for multi-digit types