

Besondere Merkmale

- Gehäusebauform: P-LCC-4
- Gehäusefarbe: weiß
- als optischer Indikator einsetzbar
- zur Hinterleuchtung, Lichtleiter- und Linseneinkopplung
- beide Leuchtdiodenchips getrennt ansteuerbar
- hohe Signalwirkung durch Farbwechsel der LED möglich
- bei geeigneter Ansteuerung, Farbwechsel von grün über gelb und orange bis super-rot möglich
- für alle SMT-Bestück- und Löttechniken geeignet
- gegurtet (12-mm-Filmgurt)
- Störimpulsfest nach DIN 40839

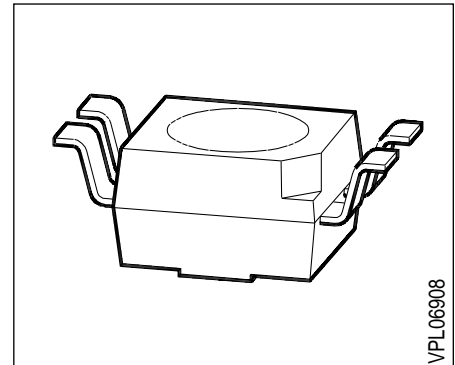

Features

- P-LCC-4 package
- color of package: white
- for use as optical indicator
- for backlighting, optical coupling into light pipes and lenses
- both chips can be controlled separately
- high signal efficiency possible by color change of the LED
- with appropriate controlling it is possible to change color from green to yellow and orange to super-red
- suitable for all SMT assembly and soldering methods
- available taped on reel (12 mm tape)
- load dump resistant acc. to DIN 40839

Typ	Emissions- farbe	Farbe der Lichtaustritts- fläche	Lichtstärke	Lichtstrom	Bestellnummer
Type	Color of Emission	Color of the Light Emitting Area	Luminous Intensity $I_F = 10 \text{ mA}$ $I_V(\text{mcd})$	Luminous Flux $I_F = 10 \text{ mA}$ $\Phi_V(\text{mlm})$	Ordering Code
LSG T770-HK	super-red /	colorless clear	2.5 ... 12.5	-	Q62703-Q2567
LSG T770-J	green		4.0 ... 8.0	18 (typ.)	Q62703-Q2893
LSG T770-K			6.3 ... 12.5	30 (typ.)	Q62703-Q2894
LSG T770-JL			4.0 ... 20.0	-	Q62703-Q2895

Streuung der Lichtstärke in einer Verpackungseinheit $I_{V \max} / I_{V \min} \leq 2.0$.¹⁾

Streuung der Lichtstärke in einer LED $I_{V \max} / I_{V \min} \leq 3.0$.

¹⁾ Bei MULTILED® bestimmt die Helligkeit des jeweils dunkleren Chips in einem Gehäuse die Helligkeitsgruppe der LED.

Luminous intensity ratio in one packaging unit $I_{V \max} / I_{V \min} \leq 2.0$.¹⁾

Luminous intensity ratio in one LED $I_{V \max} / I_{V \min} \leq 3.0$.

¹⁾ In case of MULTILED®, the brightness of the darker chip in one package determines the brightness group of the LED.

Grenzwerte Maximum Ratings

Bezeichnung Parameter	Symbol Symbol	Wert Value	Einheit Unit
Betriebstemperatur Operating temperature range	T_{op}	- 55 ... + 100	°C
Lagertemperatur Storage temperature range	T_{stg}	- 55 ... + 100	°C
Sperrschichttemperatur Junction temperature	T_j	+ 100	°C
Durchlaßstrom Forward current	I_F	30	mA
Stoßstrom Surge current $t \leq 10 \mu s, D = 0.005$	I_{FM}	0.5	A
Sperrspannung Reverse voltage	V_R	5	V
Verlustleistung Power dissipation	P_{tot}	100	mW
Wärmewiderstand Thermal resistance Sperrschicht / Umgebung Junction / air Montage auf PC-Board*) (Padgröße $\geq 16 \text{ mm}^2$) mounted on PC board*) (pad size $\geq 16 \text{ mm}^2$)	$R_{th JA}^{1)}$ $R_{th JA}^{2)}$	480 650	K/W K/W

*) PC-board: FR4

1) nur ein Chip betrieben

1) one system only

2) beide Chips betrieben

2) both systems on simultaneously

Notes

Die angegebenen Grenzdaten gelten für einen Chip.

The stated maximum ratings refer to one chip.

Kennwerte ($T_A = 25\text{ °C}$)

Characteristics

Bezeichnung Parameter	Symbol Symbol	Wert Value		Einheit Unit
		LS	LG	
Wellenlänge des emittierten Lichtes (typ.) Wavelength at peak emission (typ.) $I_F = 10\text{ mA}$	λ_{peak}	635	565	nm
Dominantwellenlänge (typ.) Dominant wavelength (typ.) $I_F = 10\text{ mA}$	λ_{dom}	628	570	nm
Spektrale Bandbreite bei 50 % $I_{\text{rel max}}$ (typ.) Spectral bandwidth at 50 % $I_{\text{rel max}}$ (typ.) $I_F = 10\text{ mA}$	$\Delta\lambda$	45	25	nm
Abstrahlwinkel bei 50 % I_V (Vollwinkel) Viewing angle at 50 % I_V	2ϕ	120	120	Grad deg.
Durchlaßspannung (typ.) Forward voltage (max.) $I_F = 10\text{ mA}$	V_F V_F	2.0 2.6	2.0 2.6	V V
Sperrstrom (typ.) Reverse current (max.) $V_R = 5\text{ V}$	I_R I_R	0.01 10	0.01 10	μA μA
Kapazität (typ.) Capacitance $V_R = 0\text{ V}, f = 1\text{ MHz}$	C_0	12	15	pF
Schaltzeiten: Switching times: I_V from 10 % to 90 % (typ.) I_V from 90 % to 10 % (typ.) $I_F = 100\text{ mA}, t_p = 10\text{ }\mu\text{s}, R_L = 50\text{ }\Omega$	t_r t_f	300 150	450 200	ns ns

Relative spektrale Emission $I_{rel} = f(\lambda)$, $T_A = 25\text{ °C}$, $I_F = 10\text{ mA}$

Relative spectral emission

$V(\lambda)$ = spektrale Augenempfindlichkeit

Standard eye response curve

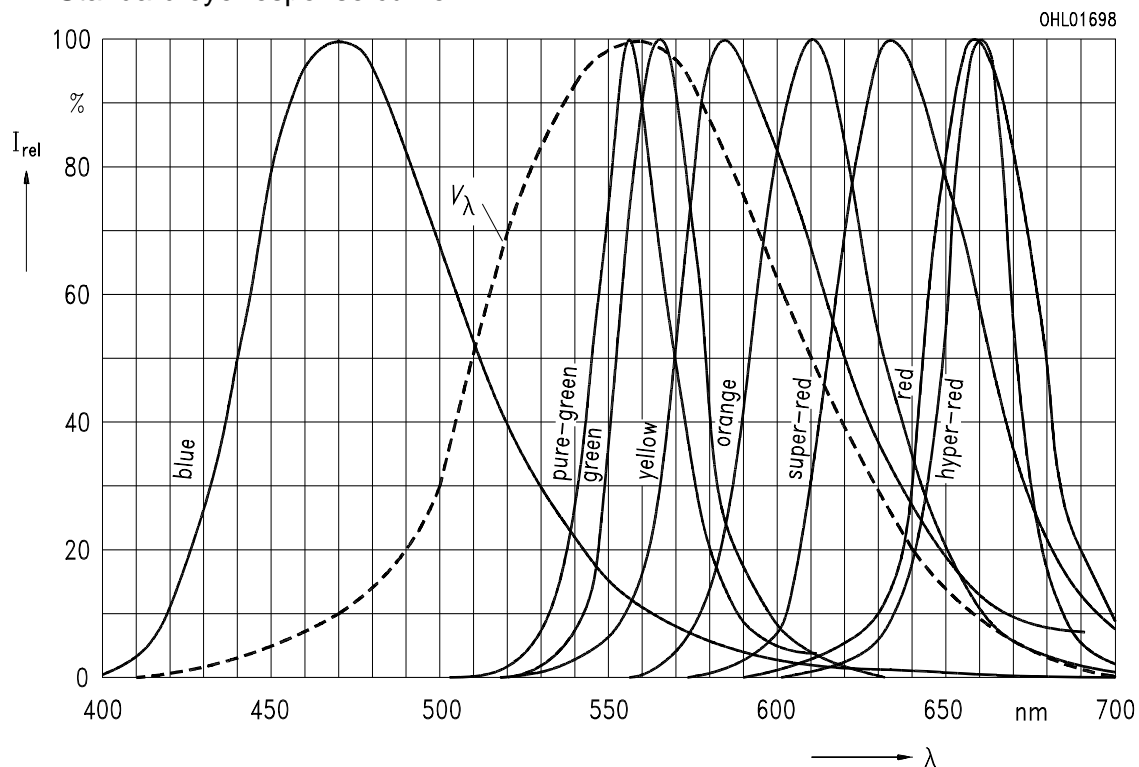

Abstrahlcharakteristik $I_{rel} = f(\varphi)$

Radiation characteristic

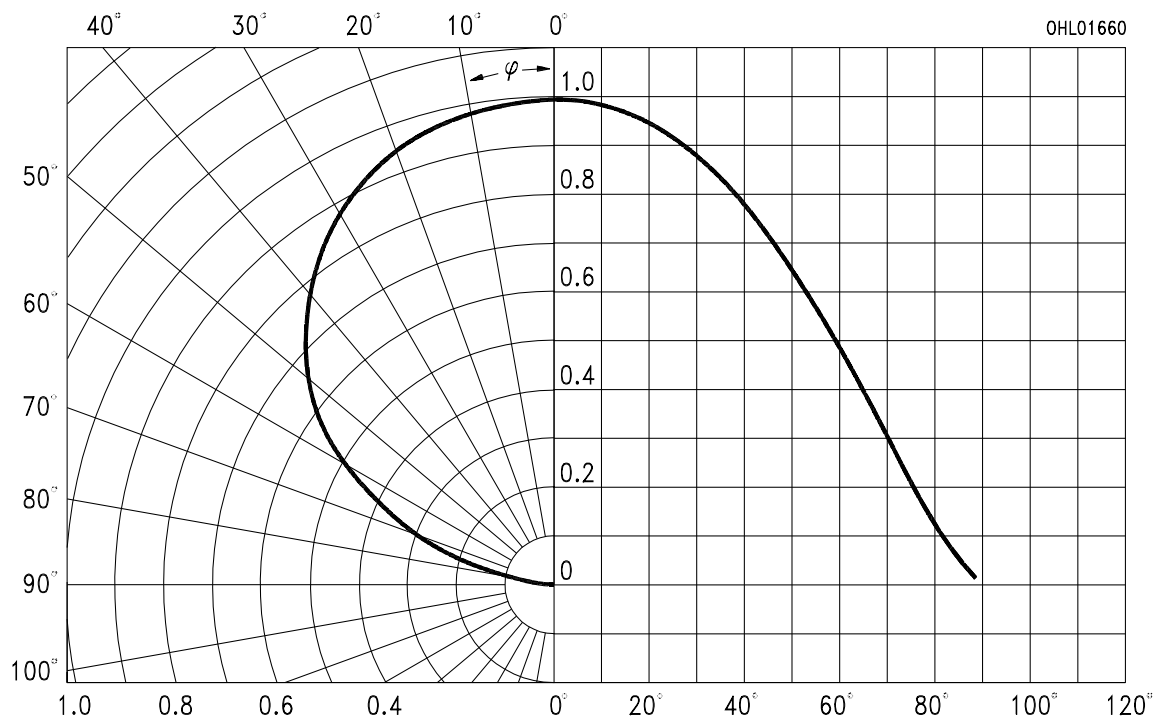

Durchlaßstrom $I_F = f(V_F)$

Forward current

$T_A = 25^\circ\text{C}$

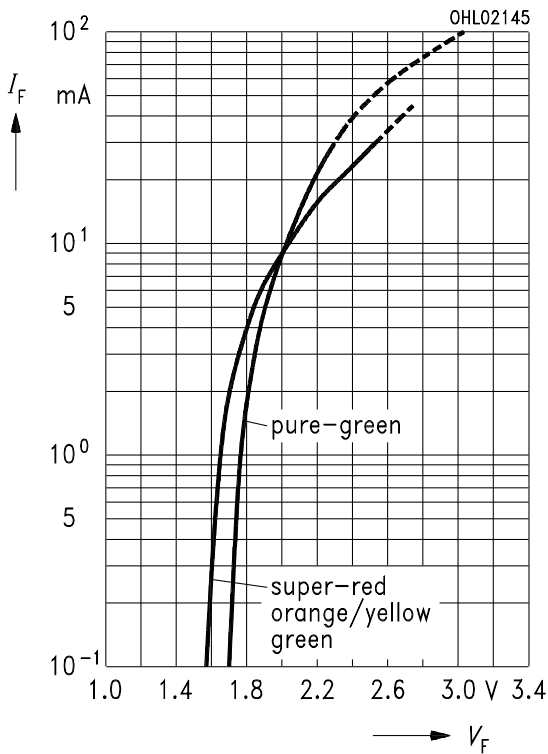

Relative Lichtstärke $I_V / I_{V(10\text{ mA})} = f(I_F)$

Relative luminous intensity

$T_A = 25^\circ\text{C}$

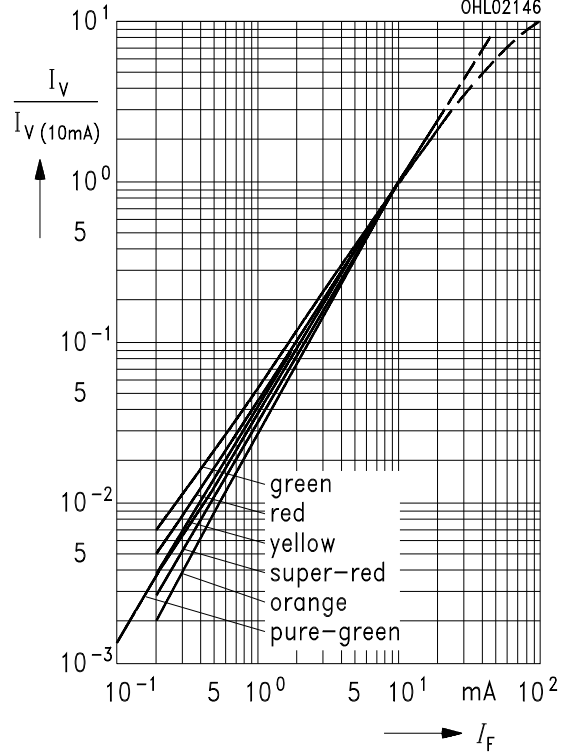

Zulässige Impulsbelastbarkeit $I_F = f(t_p)$

Permissible pulse handling capability

Duty cycle $D =$ parameter, $T_A = 25^\circ\text{C}$

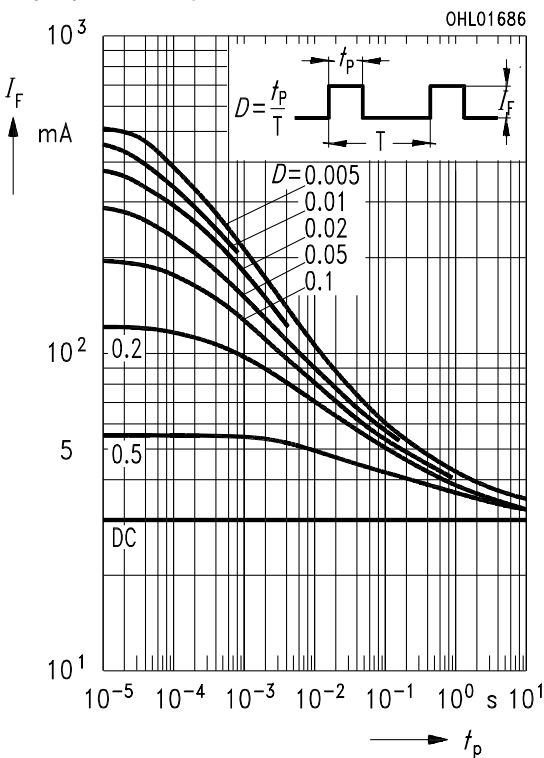

Maximal zulässiger Durchlaßstrom $I_F = f(T_A)$

Max. permissible forward current

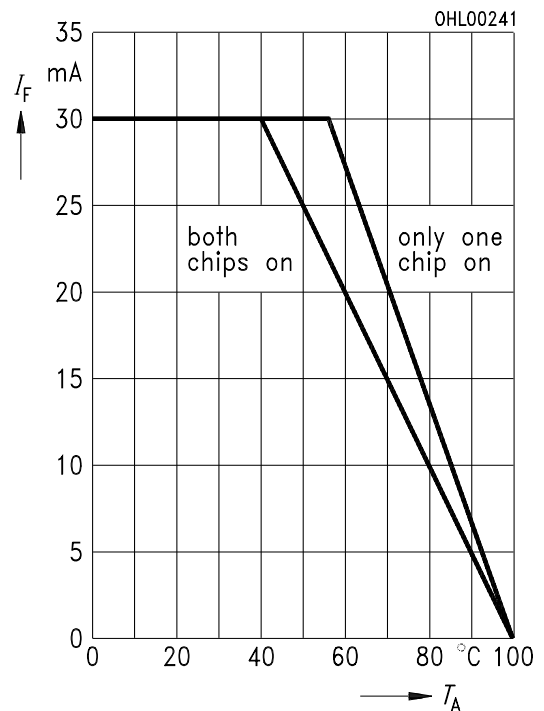

Wellenlänge der Stahlung $\lambda_{\text{peak}} = f(T_A)$
Wavelength at peak emission

$I_F = 10 \text{ mA}$

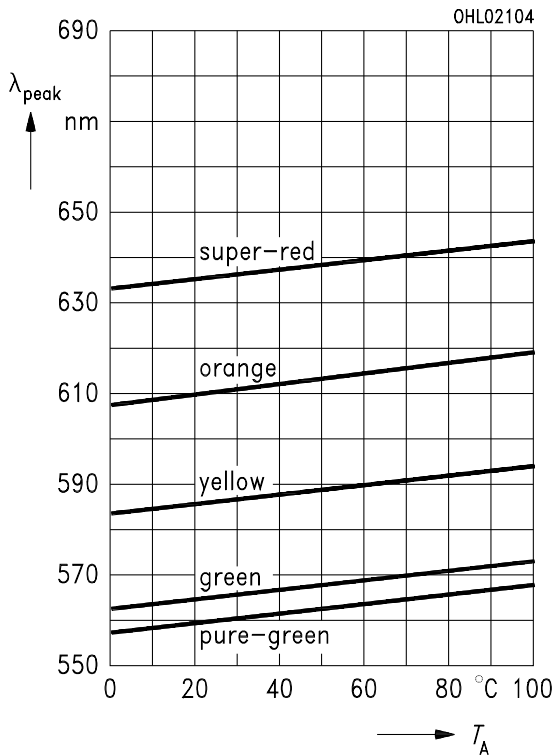

Dominantwellenlänge $\lambda_{\text{dom}} = f(T_A)$
Dominant wavelength

$I_F = 10 \text{ mA}$

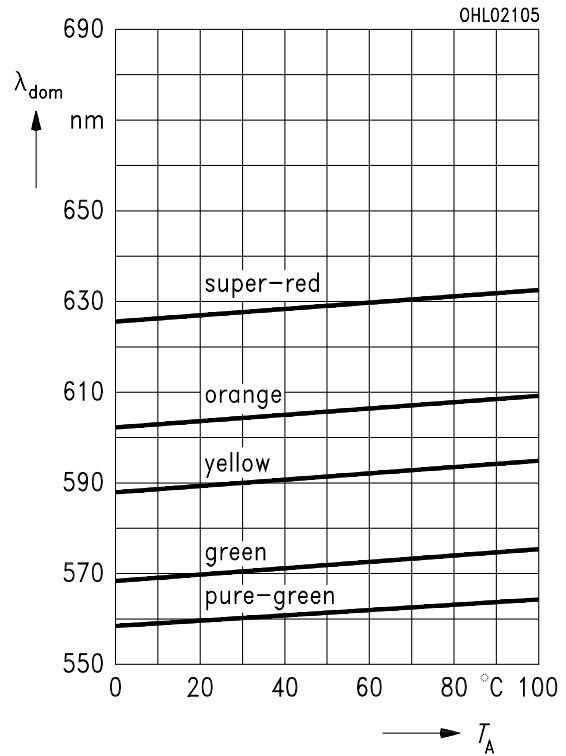

Durchlaßspannung $V_F = f(T_A)$
Forward voltage

$I_F = 10 \text{ mA}$

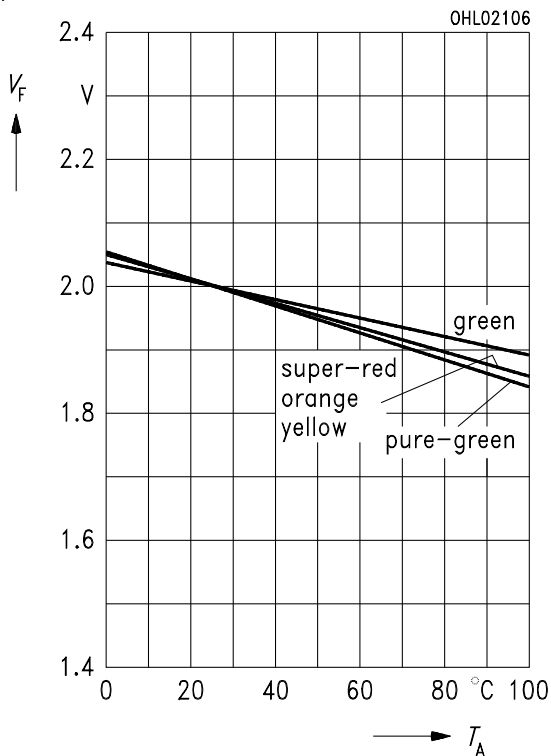

Relative Lichtstärke $I_V / I_{V(25^\circ\text{C})} = f(T_A)$
Relative luminous intensity

$I_F = 10 \text{ mA}$

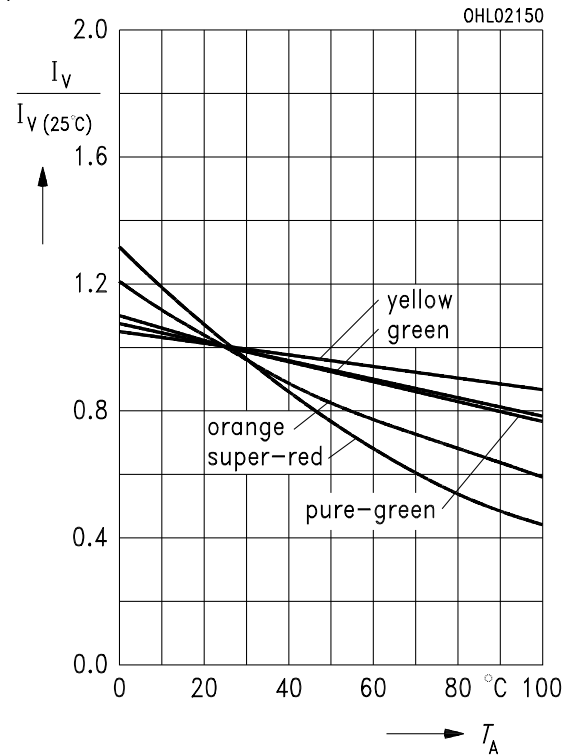

Maßzeichnung (Maße in mm, wenn nicht anders angegeben)
Package Outlines (Dimensions in mm, unless otherwise specified)

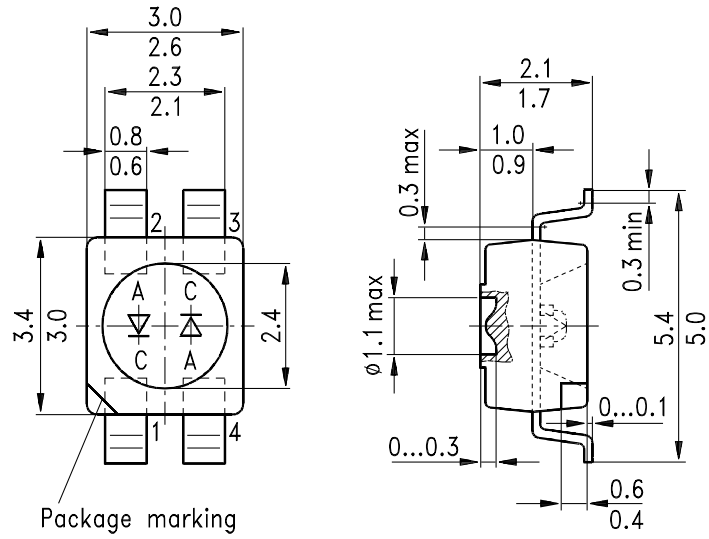

L	S	G	T770
LED	Emission color 1	Emission color 2	Package
	cathode: pin 1	cathode: pin 3	

GPL06908