

1.5A Buck Converter, 1.5A Boost Converter and LDO Controller

FEATURES

- 2.5V to 36V Input Voltage Range
- Programmable Switching Frequency from 500kHz to 2.1MHz
- Synchronizable Up to 2.75MHz
- $V_{OUT(MIN)}$: 0.8V
- Independent Soft-Start for Each Converter
- Separate V_{IN} Supplies for Each Converter
- Duty Cycle Range: 0% to 90% at 1MHz
- Available in 24-Lead (4mm × 4mm) QFN and 20-Lead TSSOP Packages

APPLICATIONS

- Cable and Satellite Set-Top Boxes
- Automotive Systems
- Telecom Systems
- “Dying Gasp” Systems
- TFT LCD Displays

DESCRIPTION

The LT[®]3570 is a buck and boost converter with internal power switches and LDO controller. Each converter is designed with a 1.5A current limit and an input range from 2.5V to 36V, making the LT3570 ideal for a wide variety of applications. Switching frequencies up to 2.1MHz are programmed with an external timing resistor and the oscillator can be synchronized to an external clock up to 2.75MHz.

The LT3570 features a programmable soft-start function that limits the feedback voltage during start-up helping prevent overshoot and limiting inrush current. The LDO controller is capable of delivering up to 10mA of base current to an external NPN transistor.

LT, LT, LTC and LTM are registered trademarks of Linear Technology Corporation. All other trademarks are the property of their respective owners.

TYPICAL APPLICATION

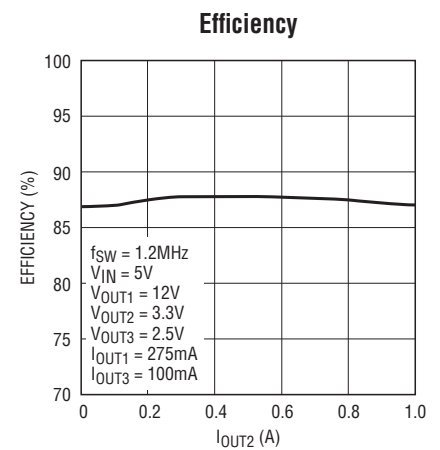
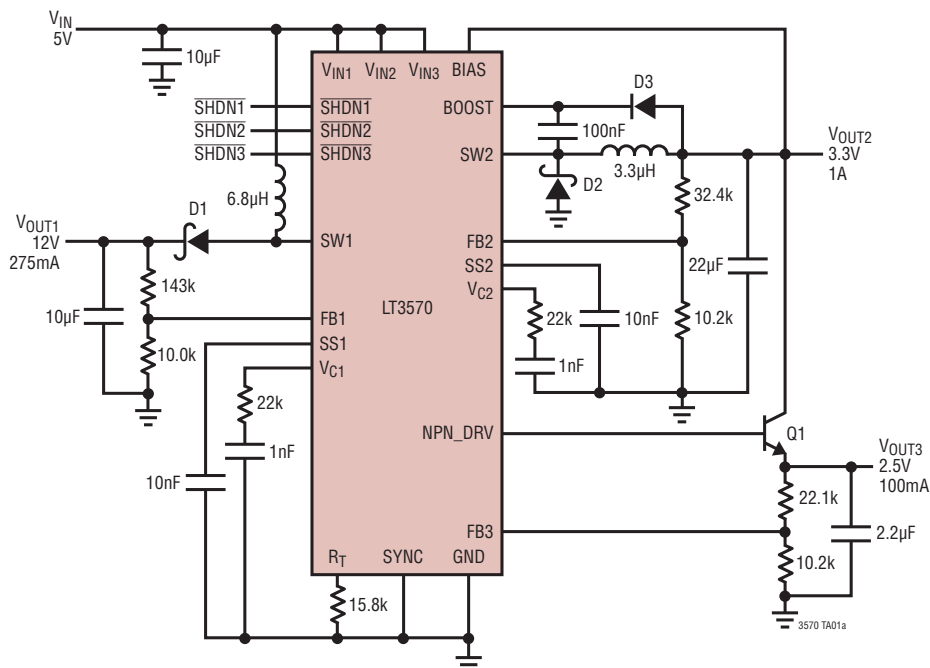

3570 TA01b

LT3570

ABSOLUTE MAXIMUM RATINGS (Note 1)

V_{IN1} , V_{IN2} , V_{IN3} , V_{BIAS} Voltage	40V	V_{C1} , V_{C2} Voltage.....	3V
BOOST Voltage	60V	Maximum Junction Temperature.....	125°C
BOOST Pin Above SW2.....	25V	Operating Temperature Range (Note 2)..	-40°C to 125°C
NPN_DRV Voltage.....	8V	Storage Temperature Range	
SW1 Voltage	40V	TSSOP	-65°C to 150°C
$\overline{SHDN1}$, $\overline{SHDN2}$, $\overline{SHDN3}$ Voltage	40V	QFN.....	-65°C to 125°C
SYNC, R_T Voltage.....	3V	Lead Temperature (Soldering, 10 sec)	
SS1, SS2 Voltage.....	3V	TSSOP Only	300°C
FB1, FB2, FB3 Voltage.....	10V		

PIN CONFIGURATION

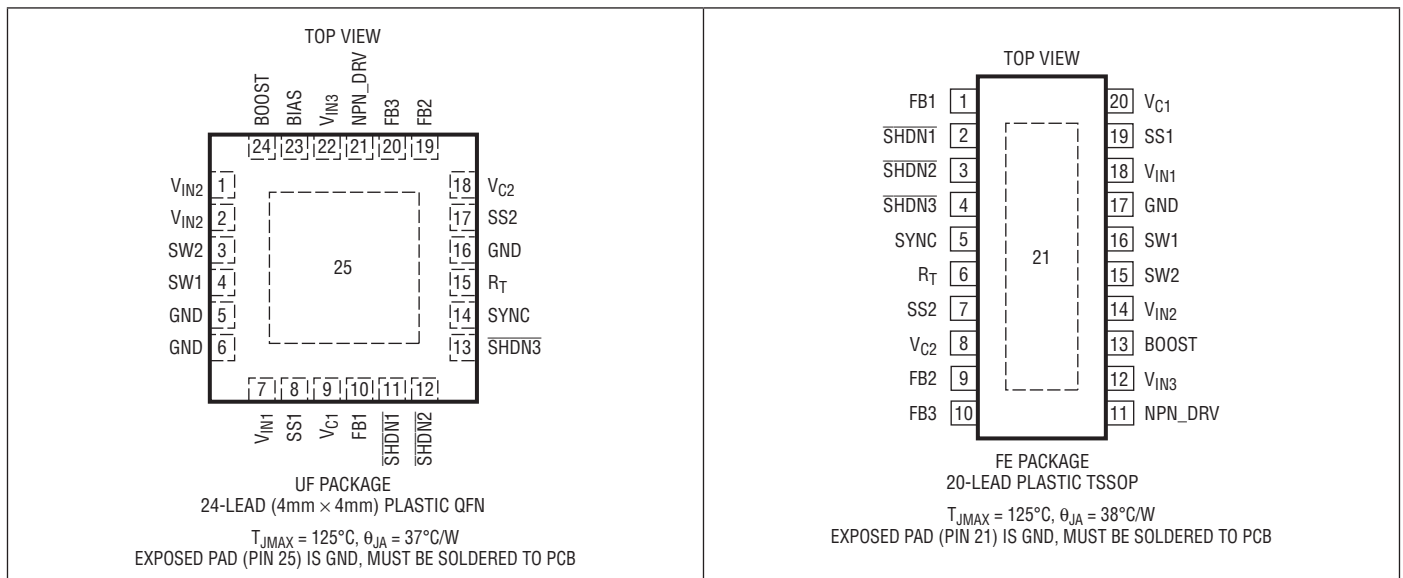

ORDER INFORMATION

LEAD FREE FINISH	TAPE AND REEL	PART MARKING*	PACKAGE DESCRIPTION	TEMPERATURE RANGE
LT3570EUF#PBF	LT3570EUF#TRPBF	3570	24-Lead (4mm × 4mm) Plastic QFN	-40°C to 125°C
LT3570IUF#PBF	LT3570IUF#TRPBF	3570	24-Lead (4mm × 4mm) Plastic QFN	-40°C to 125°C
LT3570EFE#PBF	LT3570EFE#TRPBF	LT3570FE	20-Lead Plastic TSSOP	-40°C to 125°C
LT3570IFE#PBF	LT3570IFE#TRPBF	LT3570FE	20-Lead Plastic TSSOP	-40°C to 125°C

Consult LTC Marketing for parts specified with wider operating temperature ranges. *The temperature grade is identified by a label on the shipping container. Consult LTC Marketing for information on non-standard lead based finish parts.

For more information on lead free part marking, go to: <http://www.linear.com/leadfree/>

For more information on tape and reel specifications, go to: <http://www.linear.com/tapeandreel/>

ELECTRICAL CHARACTERISTICS The ● denotes the specifications which apply over the full operating temperature range, otherwise specifications are at $T_A = 25^\circ\text{C}$. $V_{IN1,2,3} = 12\text{V}$, $V_{SHDN1,2,3} = 12\text{V}$ unless otherwise noted.

PARAMETER	CONDITIONS		MIN	TYP	MAX	UNITS
Minimum Operating Voltage (V_{IN1})	(Note 3)	●		2.1	2.5	V
Minimum Operating Voltage (V_{IN2})	(Note 3)	●		2.1	2.5	V
Shutdown Current (Note 4)	$V_{SHDN1,2,3} = 0\text{V}$			0	1.5	μA
V_{IN1} Quiescent Current	$V_{SHDN1} = 12\text{V}$, $V_{SHDN2,3} = 0\text{V}$, $V_{C1} = 0.4\text{V}$ (Not Switching) $V_{SHDN1} = 0\text{V}$, $V_{SHDN2,3} = 12\text{V}$			3.2 65	4.5 150	mA μA
V_{IN2} Quiescent Current	$V_{SHDN1,3} = 0\text{V}$, $V_{SHDN2} = 12\text{V}$, $V_{C2} = 0.4\text{V}$ (Not Switching) $V_{SHDN1,3} = 12\text{V}$, $V_{SHDN2} = 0\text{V}$			3.5 3.5	4.5 4.5	mA mA
V_{IN3} Quiescent Current	$V_{SHDN1,2} = 0\text{V}$, $V_{SHDN3} = 12\text{V}$ $V_{SHDN1,2} = 12\text{V}$, $V_{SHDN3} = 0\text{V}$			700 0	950 1.5	μA μA
Bias Quiescent Current	$V_{BIAS} = 2.5\text{V}$			2.3	3.1	mA
$V_{SHDN1,2,3}$ Pin Threshold	$I_{VIN2} > 100\mu\text{A}$		0.3		1.4	V
$V_{SHDN1,2,3}$ Pin UVLO		●	1.1	1.25	1.4	V
V_{SHDNX} Pin Current	$V_{SHDNX} = 12\text{V}$, $V_{SHDNY,Z} = 0\text{V}$ (Note 5) $V_{SHDN1,2,3} = 0\text{V}$			30 0.1	50 1.5	μA μA
Switching Frequency	$R_T = 44.2\text{k}$ $R_T = 7.87\text{k}$		450 1900	500 2100	550 2300	kHz kHz
Maximum Duty Cycle	$R_T = 44.2\text{k}$ $R_T = 7.87\text{k}$		95 80			% %
Synchronous Frequency Threshold			0.3		1.5	V
Synchronous Frequency Range			650		2750	kHz
Synchronous Frequency Minimum On/Off Time			50			ns
FB1,2,3 Pin Voltage		●	772	788	804	mV
FB1,2,3 Pin Voltage Line Regulation	$V_{VIN1,2,3} = 2.5\text{V}$ to 36V , $V_{C1,2} = 1\text{V}$			0.01		%/V
FB1,2 Pin Bias Current	$V_{FB1,2} = 800\text{mV}$, $V_{C1,2} = 1\text{V}$ (Note 6)			30	200	nA
FB3 Pin Bias Current	$V_{FB3} = 800\text{mV}$ (Note 6)			30	200	nA
SS1,2 Pin Source Current	$V_{SS1,2} = 500\text{mV}$			4.5		μA
$V_{C1,2}$ Pin Source Current	$V_{FB1,2} = 600\text{mV}$			12		μA
$V_{C1,2}$ Pin Sink Current	$V_{FB1,2} = 1\text{V}$			12		μA
SW1						
Error Amplifier 1 Transconductance				190		μMho
Error Amplifier 1 Voltage Gain				100		V/V
V_{C1} Pin Switching Threshold				750		mV
V_{C1} to SW1 Current Gain				5.9		A/V
SW1 Current Limit	(Note 7)		1.5	2.4	3.1	A
SW1 V_{CESAT}	$I_{SW1} = 1\text{A}$ (Note 7)			240		mV
SW1 Leakage Current	SW1 = 40V, $V_{SHDN1} = 0\text{V}$			0.2	5	μA

ELECTRICAL CHARACTERISTICS

The ● denotes the specifications which apply over the full operating temperature range, otherwise specifications are at $T_A = 25^\circ\text{C}$. $V_{IN1,2,3} = 12\text{V}$, $V_{SHDN1,2,3} = 12\text{V}$ unless otherwise noted.

PARAMETER	CONDITIONS	MIN	TYP	MAX	UNITS
SW2					
Error Amplifier 2 Transconductance			195		μMho
Error Amplifier 2 Voltage Gain			100		V/V
V_{C2} Pin Switching Threshold			700		mV
V_{C2} to SW2 Current Gain			5.4		A/V
SW2 Current Limit	(Note 7)	1.5	2.4	3.1	A
SW2 V_{CESAT}	$I_{SW2} = 1\text{A}$ (Note 7)		240		mV
SW2 Leakage Current	SW2 = 0V, $V_{IN2} = 40\text{V}$, $V_{SHDN2} = 0\text{V}$		0.2	5	μA
BOOST Pin Current	$I_{SW2} = 0.5\text{A}$ $I_{SW2} = 1.5\text{A}$		15 30		mA mA
LDO					
LDO Maximum Output Current	$V_{FB3} = 600\text{mV}$		10	20	mA

Note 1: Stresses beyond those listed under Absolute Maximum Ratings may cause permanent damage to the device. Exposure to any Absolute Maximum Rating condition for extended periods may affect device reliability and lifetime.

Note 2: The LT3570E is guaranteed to meet performance specifications from 0°C to 125°C junction temperature. Specifications over the -40°C to 125°C operating junction temperature range are assured by design, characterization and correlation with statistical process controls. The LT3570I is guaranteed over the full -40°C to 125°C operating junction temperature range.

Note 3: V_{IN2} supplies power for the part. V_{IN1} supplies power only to the boost converter. V_{IN3} supplies power only to the LDO Controller.

Note 4: Shutdown current is for each individual input current.

Note 5: Current flows into the pin.

Note 6: Current flows out of the pin.

Note 7: Switch current limit and switch V_{CESAT} guaranteed by design and/or correlation to static test.

Note 8: This IC includes overtemperature protection that is intended to protect the device during momentary overload conditions. Junction temperature will exceed the maximum operating junction temperature range when overtemperature protection is active. Continuous operation above the specified maximum operating junction temperature may impair device reliability.

TYPICAL PERFORMANCE CHARACTERISTICS

Feedback Voltage vs Temperature

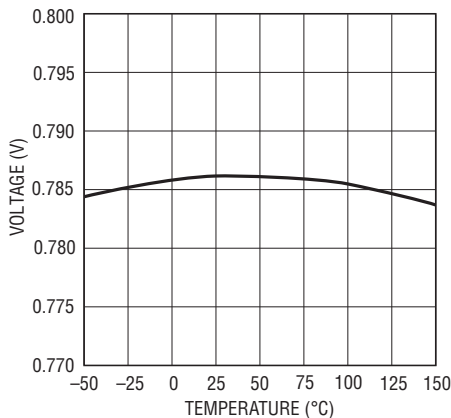

3570 G01

Frequency vs Temperature

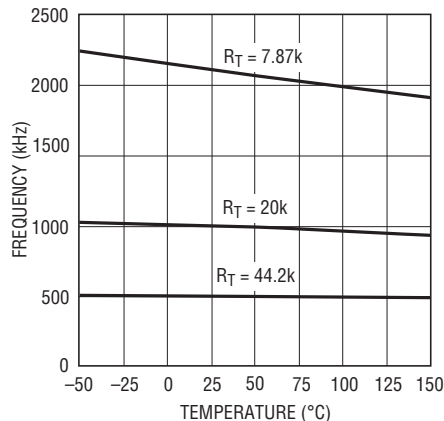

3570 G02

Soft-Start Current vs Temperature

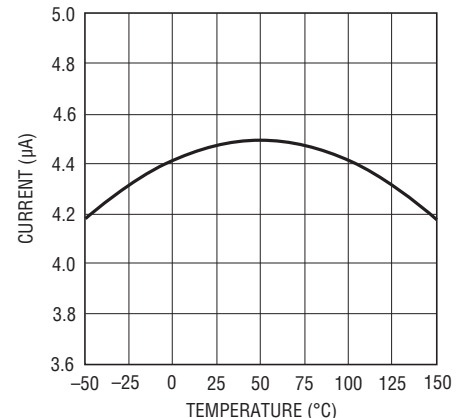

3570 G03

TYPICAL PERFORMANCE CHARACTERISTICS

V_{IN1} Quiescent Current vs Temperature

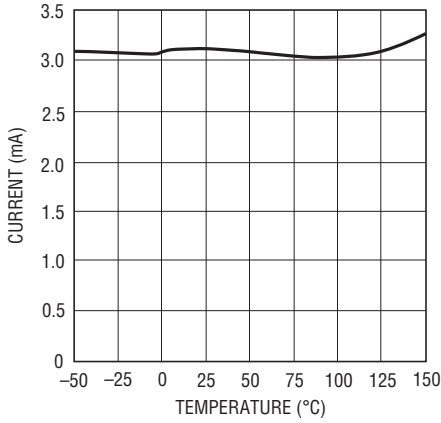

3570 G04

V_{IN2} Quiescent Current vs Temperature

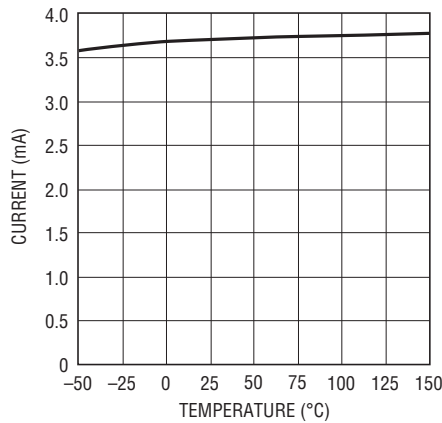

3570 G05

V_{IN3} Quiescent Current vs Temperature

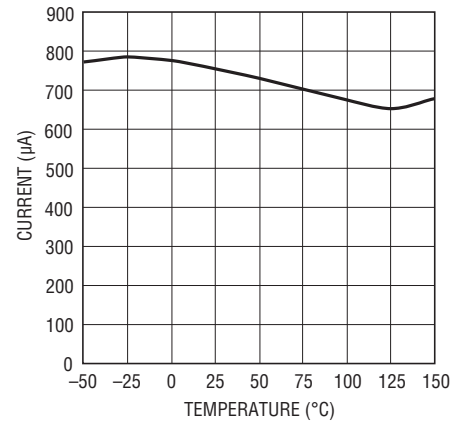

3570 G06

Bias Pin Current vs Temperature

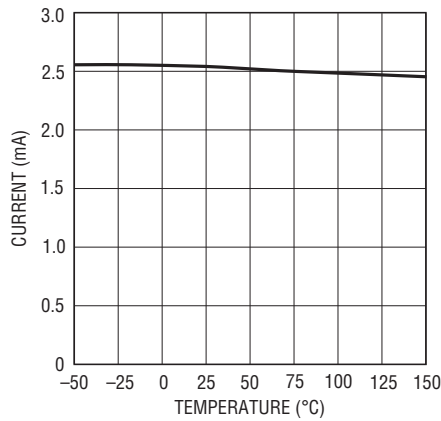

3570 G07

SHDN Pin UVLO vs Temperature

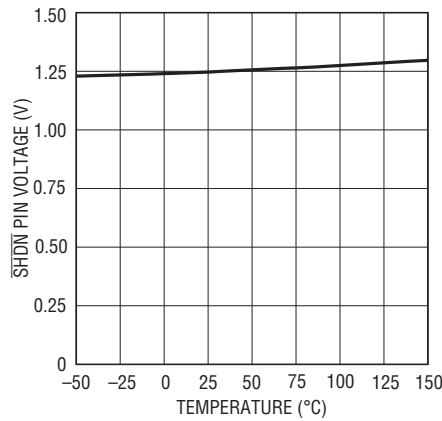

3570 G08

SHDN Pin Current vs Voltage

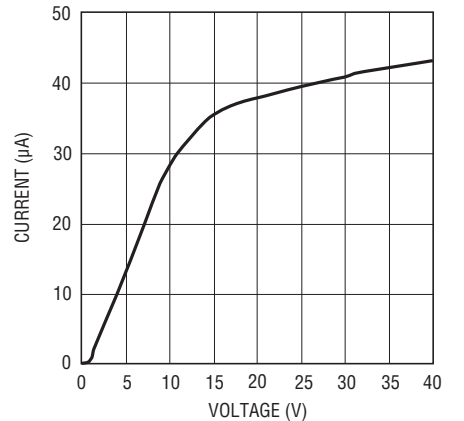

3570 G09

SW1 Current Limit vs Duty Cycle

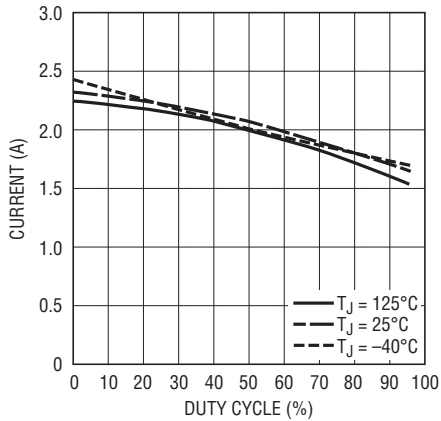

3570 G10

SW1 Saturation Voltage vs SW1 Current

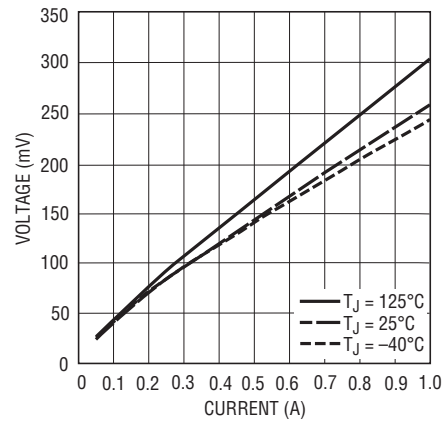

3570 G11

TYPICAL PERFORMANCE CHARACTERISTICS

SW2 Current Limit vs Duty Cycle

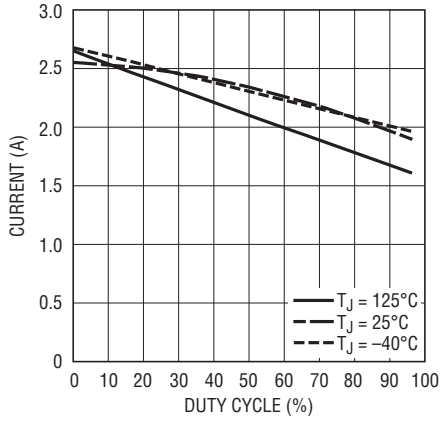

3570 G12

SW2 Saturation Voltage vs SW2 Current

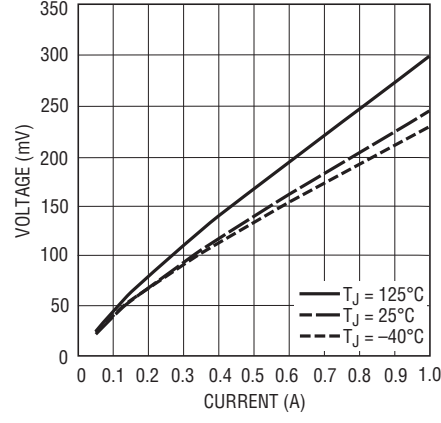

3570 G13

BOOST Pin Current vs Switch Current

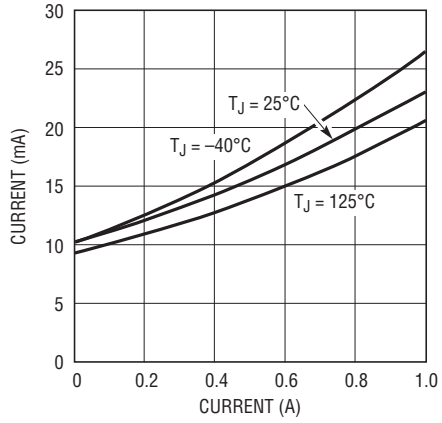

3570 G14

NPN_DRV Output Current vs V_{IN3}

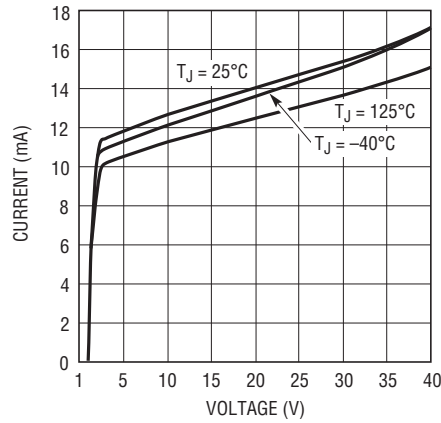

3570 G15

PIN FUNCTIONS (QFN/TSSOP)

V_{IN2} (Pins 1,2/Pin 14): Input Voltage for the Buck Regulator. This pin also supplies the current to the internal circuitry of the LT3570. This pin must be locally bypassed with a capacitor.

SW2 (Pin 3/Pin 15): Switch Node. This pin connects to the emitter of an internal NPN power switch. Connect a diode, inductor and boost capacitor to this pin to form the buck regulator.

SW1 (Pin 4/Pin 16): Switch Node. This pin connects to the collector of an internal NPN power switch. Connect a diode and inductor to this pin to form the boost regulator.

GND (Pins 5, 6, 16, 25/Pins 17, 21): Ground. The Exposed Pad of the package provides both electrical contact to ground and good thermal contact to the printed circuit board. The Exposed Pad must be soldered to the circuit board for proper operation.

V_{IN1} (Pin 7/Pin 18): Input Voltage for the Boost Regulator. This pin supplies current to drive the boost NPN transistor of the LT3570. This pin must be locally bypassed with a capacitor.

SS1 (Pin 8/Pin 19): Soft-Start Pin. Place a soft-start capacitor here. Upon start-up, a current charges the capacitor to 2V. This pin ramps the reference voltage of the boost switcher.

V_{C1} (Pin 9/Pin 20): Control Voltage and Compensation Pin for the Internal Error Amplifier. Connect a series RC from this pin to ground to compensate the switching regulator loop for the boost regulator.

FB1 (Pin 10/Pin 1): Feedback Pin. The LT3570 regulates this pin to 788mV. Connect the feedback resistors to this pin to set the output voltage for the boost switching regulator.

SHDN1 (Pin 11/Pin 2): Shutdown Pin. Tie to 1.4V or more to enable the boost switcher. Tie all SHDN pins to 0.3V or less to shutdown the part.

SHDN2 (Pin 12/Pin 3): Shutdown Pin. Tie to 1.4V or more to enable the buck switcher. Tie all SHDN pins to 0.3V or less to shutdown the part.

SHDN3 (Pin 13/Pin 4): Shutdown Pin. Tie to 1.5V or more to enable the NPN LDO. Tie all SHDN pins to 0.3V or less to shutdown the part.

SYNC (Pin 14/Pin 5): Synchronization Pin. The SYNC pin is used to synchronize the internal oscillator to an external signal. The synchronizing range is equal to the initial operating frequency set by the R_T pin up to 1.3 times the initial operating frequency.

R_T (Pin 15/Pin 6): Frequency Set Pin. Place a resistor to GND to set the internal frequency. The range of oscillation is 500kHz to 2MHz.

SS2 (Pin 17/Pin 7): Soft-Start Pin. Place a soft-start capacitor here. Upon start-up, a current charges the capacitor to 2V. This pin ramps the reference voltage of the buck switcher.

V_{C2} (Pin 18/Pin 8): Control Voltage and Compensation Pin for the Internal Error Amplifier. Connect a series RC from this pin to ground to compensate the switching regulator loop for the buck regulator.

FB2 (Pin 19/Pin 9): Feedback Pin. The LT3570 regulates this pin to 788mV. Connect the feedback resistors to this pin to set the output voltage for the buck switching regulator.

FB3 (Pin 20/Pin 10): Feedback Pin. The LT3570 regulates this pin to 788mV. Connect the feedback resistors to this pin to set the output voltage for the LDO controller.

NPN_DRIVE (Pin 21/Pin 11): Base Drive for the External NPN. This pin provides a bias current to drive the base of the NPN. This base current is driven from the IN3 supply voltage.

V_{IN3} (Pin 22/Pin 12): Input Voltage for the NPN LDO. This pin supplies current to drive the base of the NPN. This pin must be locally bypassed with a capacitor.

BIAS (Pin 23): QFN Package Only. This pin supplies current to the internal circuitry of the LT3570 if greater than 2.5V. This pin must be locally bypassed with a capacitor.

BOOST (Pin 24/Pin 13): Bias for the Base Drive of the NPN Switch for the Buck Regulator. This pin provides a bias voltage higher than V_{IN2}. The voltage on this pin is charged up through an external Schottky diode.

OPERATION

The LT3570 is a constant frequency, current mode, buck converter and boost converter with an NPN LDO regulator. Operation can be best understood by referring to the Block Diagram.

If all of the $\overline{\text{SHDN}}$ pins are held low, the LT3570 is shut down and draws zero quiescent current. When any of the pins exceed 1.4V the internal bias circuits turn on. Each regulator will only begin regulating when its corresponding $\overline{\text{SHDN}}$ pin is pulled high.

Each switching regulator controls the output voltage in a similar manner. The operation of the switchers can be understood by looking at the boost regulator. A pulse from the oscillator sets the RS flip-flop A4 and turns on the internal NPN bipolar power switch Q1. Current in Q1 and the external inductor L1 begins to increase. When this current exceeds a level determined by the voltage at V_{C1} , comparator A3 resets A4, turning off Q1. The current in L1 flows through the external Schottky diode D1 and begins to decrease. The cycle begins again at the next pulse from the oscillator. In this way, the voltage on the

V_{C1} pin controls the current through the inductor to the output. The internal error amplifier A1 regulates the output voltage by continually adjusting the V_{C1} pin voltage. The threshold for switching on the V_{C1} pin is approximately 750mV and an active clamp of 1.15V limits the output current. The soft-start capacitor C6A allows the part to slowly start up by ramping the internal reference.

The driver for the buck regulator can operate from either V_{IN2} or from the BOOST pin. An external capacitor and diode are used to generate a voltage at the BOOST pin that is higher than the input supply. This allows the driver to saturate the internal bipolar NPN power switch for efficient operation. The driver for the boost regulator is operated from V_{IN1} .

The BIAS pin allows the internal circuitry to draw its current from a lower voltage supply than the input. This reduces power dissipation and increases efficiency. If the voltage on the BIAS pin falls below 2.5V, then the LT3570 quiescent current will flow from V_{IN2} .

APPLICATIONS INFORMATION

FB Resistor Network

The output voltage is programmed with a resistor divider (refer to the Block Diagram) between the output and the FB pin. Choose the resistors according to:

$$R1 = R2 \left(\frac{V_{OUT}}{788mV} - 1 \right)$$

Buck Inductor Selection and Maximum Output Current

A good first choice for the inductor value is

$$L = \frac{V_{OUT2} + V_F}{0.75 \cdot f} \text{ for SW2}$$

where V_F is the voltage drop of the catch diode (~0.4V) and f is the switching frequency. With this inductance value or greater, the maximum load current will be 1A, independent of input voltage. The inductor's RMS current rating must be greater than the maximum load current and its saturation current should be at least 30% higher. For highest efficiency, the series resistance (DCR) should be less than 0.1Ω. Table 1 lists several vendors and types that are suitable.

Table 1. Inductors

PART NUMBER	VALUE (μH)	I _{SAT} (A)	DCR (Ω)	HEIGHT (mm)
Sumida				
CDRH4D28-3R3	3.3	1.57	0.049	3.0
CDRH4D28-4R7	4.7	1.32	0.072	3.0
CDC5D23-2R2	2.2	2.50	0.03	2.5
CR43-3R3	3.3	1.44	0.086	3.5
CDRH5D28-100	10	1.3	0.048	3.0
Coilcraft				
DO1608C-332	3.3	2.00	0.080	2.9
DO1608C-472	4.7	1.50	0.090	2.9
MOS6020-332	3.3	1.8	0.046	2.0
D03314-103	10	0.8	0.520	1.4
D03314-222	2.2	1.6	0.200	1.4
Toko				
(D62F)847FY-2R4M	2.4	2.5	0.037	2.7
(D73LF)817FY-2R2M	2.2	2.7	0.03	3.0
Coiltronics				
TP3-4R7	4.7	1.5	0.181	2.2
TP1-2R2	2.2	1.3	0.188	1.8
TP4-100	10	1.5	0.146	3.0

The optimum inductor for a given application may differ from the one indicated by this simple design guide. A larger value inductor provides a slightly higher maximum load current and will reduce the output voltage ripple. If your load is lower than the maximum load current, then you can relax the value of the inductor and operate with higher ripple current. This allows you to use a physically smaller inductor or one with a lower DCR resulting in higher efficiency. Be aware that if the inductance differs from the simple rule above, then the maximum load current will depend on input voltage. In addition, low inductance may result in discontinuous mode operation, which further reduces maximum load current. For details of maximum output current and discontinuous mode operation, see Linear Technology's Application Note 44. Finally, for duty cycles greater than 50% ($V_{OUT2}/V_{IN2} > 0.5$) a minimum inductance is required to avoid subharmonic oscillations, see Application Note 19.

The current in the inductor is a triangle wave with an average value equal to the load current. The peak switch current is equal to the output current plus half the peak-to-peak inductor ripple current. The LT3570 limits its switch current in order to protect itself and the system from overload faults. Therefore, the maximum output current that the LT3570 will deliver depends on the switch current limit, the inductor value and the input and output voltages.

When the switch is off, the potential across the inductor is the output voltage plus the catch diode drop. This gives the peak-to-peak ripple current in the inductor:

$$\Delta I_{L2} = \frac{(1-DC2)(V_{OUT2} + V_F)}{L \cdot f}$$

where DC2 is the duty cycle and is defined as:

$$DC2 = \frac{V_{OUT2}}{V_{IN2}}$$

The peak inductor and switch current is:

$$I_{SWPK2} = I_{LPK2} = I_{OUT2} + \frac{\Delta I_{L2}}{2}$$

To maintain output regulation, this peak current must be less than the LT3570's switch current limit I_{LIM2} . I_{LIM2} is at least 1.5A at low duty cycles and decreases linearly

3570fb

APPLICATIONS INFORMATION

to 1.2A at DC2 = 0.8. The maximum output current is a function of the chosen inductor value:

$$I_{OUT2(MAX)} = I_{LIM2} - \frac{\Delta I_{L2}}{2}$$

$$= 1.5 \cdot (1 - 0.25 \cdot DC2) - \frac{\Delta I_{L2}}{2}$$

Choosing an inductor value so that the ripple current is small will allow a maximum output current near the switch current limit.

One approach to choosing the inductor is to start with the simple rule given above, look at the available inductors and choose one to meet cost or space goals. Then use these equations to check that the LT3570 will be able to deliver the required output current. Note again that these equations assume that the inductor current is continuous. Discontinuous operation occurs when I_{OUT2} is less than $\Delta I_{L2}/2$.

Boost Inductor Selection

For most applications the inductor will fall in the range of 2.2 μ H to 22 μ H. Lower values are chosen to reduce physical size of the inductor. Higher values allow more output current because they reduce peak current seen by the power switch, which has a 1.5A current limit. Higher values also reduce input ripple voltage and reduce core loss. The following procedure is suggested as a way of choosing a more optimum inductor.

Assume that the average inductor current for a boost converter is equal to the load current times V_{OUT1}/V_{IN1} and decide whether or not the inductor must withstand continuous overload conditions. If average inductor current at maximum load current is 0.5A, for instance, a 0.5A inductor may not survive a continuous 1.5A overload condition. Also be aware that boost converters are not short-circuit protected, and that under short conditions, inductor current is limited only by the available current of the input supply.

Calculate peak inductor current at full load current to ensure that the inductor will not saturate. Peak current can be significantly higher than output current, especially with smaller inductors and lighter loads, so don't omit this step.

Powdered iron cores are forgiving because they saturate softly, whereas ferrite cores saturate abruptly. Other core materials fall somewhere in between. The following formula assumes continuous mode operation but it errs only slightly on the high side for discontinuous mode, so it can be used for all conditions.

$$I_{PEAK1} = \frac{I_{OUT1} \cdot V_{OUT1}}{V_{IN1}} + \frac{V_{IN1}(V_{OUT1} - V_{IN1})}{2 \cdot f \cdot L \cdot V_{OUT1}}$$

Make sure that I_{PEAK1} is less than the switch current I_{LIM1} . I_{LIM1} is at least 1.5A at low duty cycles and decreases linearly to 1.2A at DC1 = 0.8. The maximum switch current limit can be calculated by the following formula:

$$I_{LIM1} = 1.5 \cdot (1 - 0.25 \cdot DC1)$$

where DC1 is the duty cycle and is defined as:

$$DC1 = 1 - \frac{V_{IN1}}{V_{OUT1}}$$

Remember also that inductance can drop significantly with DC current and manufacturing tolerance. Consideration should also be given to the DC resistance of the inductor as this contributes directly to the efficiency losses in the overall converter. Table 1 lists several inductor vendors and types that are suitable.

Buck Output Capacitor Selection

For 5V and 3.3V outputs, a 10 μ F, 6.3V ceramic capacitor (X5R or X7R) at the output results in very low output voltage ripple and good transient response. For lower voltages, 10 μ F is adequate for ripple requirements but increasing C_{OUT} will improve transient performance. Other types and values will also work; the following discusses tradeoffs in output ripple and transient performance.

The output capacitor filters the inductor current to generate an output with low voltage ripple. It also stores energy in order to satisfy transient loads and stabilize the LT3570's control loop. Because the LT3570 operates at a high frequency, minimal output capacitance is necessary. In addition, the control loop operates well with or without the presence of output capacitor series resistance (ESR). Ceramic capacitors, which achieve very low output ripple

APPLICATIONS INFORMATION

and small circuit size, are therefore an option. You can estimate output ripple with the following equations:

$$V_{\text{RIPPLE}} = \frac{\Delta I_{L2}}{8 \cdot f \cdot C_{\text{OUT}}} \text{ for ceramic capacitors}$$

and

$$V_{\text{RIPPLE}} = \Delta I_{L2} \cdot \text{ESR for electrolytic capacitors (tantalum and aluminum)}$$

The RMS content of this ripple is very low so the RMS current rating of the output capacitor is usually not of concern. It can be estimated with the formula:

$$I_{C(\text{RMS})} = \frac{\Delta I_{L2}}{\sqrt{12}}$$

Another constraint on the output capacitor is that it must have greater energy storage than the inductor; if the stored energy in the inductor transfers to the output, the resulting voltage step should be small compared to the regulation voltage. For a 5% overshoot, this requirement indicates:

$$C_{\text{OUT}} > 10 \cdot L \cdot \left(\frac{I_{\text{LIM2}}}{V_{\text{OUT2}}} \right)^2$$

The low ESR and small size of ceramic capacitors make them the preferred type for LT3570 applications. Not all ceramic capacitors are the same, however. Many of the higher value capacitors use poor dielectrics with high temperature and voltage coefficients. In particular, Y5V and Z5U types lose a large fraction of their capacitance with applied voltage and at temperature extremes. Because loop stability and transient response depend on the value of C_{OUT} , this loss may be unacceptable. Use X7R and X5R types.

Electrolytic capacitors are also an option. The ESRs of most aluminum electrolytic capacitors are too large to deliver low output ripple. Tantalum, as well as newer, lower ESR organic electrolytic capacitors intended for power supply use are suitable. Choose a capacitor with a low enough ESR for the required output ripple. Because the volume of the capacitor determines its ESR, both the size and the value will be larger than a ceramic capacitor that would give similar ripple performance. One benefit is that the larger capacitance may give better transient

response for large changes in load current. Table 2 lists several capacitor vendors.

Table 2. Low ESR Surface Mount Capacitors

VENDOR	TYPE	SERIES
Taiyo Yuden	Ceramic	X5R, X7R
AVX	Ceramic Tantalum	X5R, X7R TPS
Kemet	Tantalum Ta Organic Al Organic	T491, T494, T495 T520 A700
Sanyo	Ta or Al Organic	POSCAP
Panasonic	Al Organic	SP CAP
TDK	Ceramic	X5R, X7R

Boost Output Capacitor Selection

Low ESR capacitors should be used at the output to minimize the output ripple voltage. Multilayer ceramic capacitors are the best choice, as they have a very low ESR and are available in very small packages. Always use a capacitor with a sufficient voltage rating. Boost regulators have large RMS ripple current in the output capacitor, which must be rated to handle the current. The formula to calculate this is:

$$I_{\text{RIPPLE(RMS)}} = I_{\text{OUT}} \sqrt{\frac{\text{DC1}}{1-\text{DC1}}} = I_{\text{OUT1}} \sqrt{\frac{V_{\text{OUT1}} - V_{\text{IN1}}}{V_{\text{IN1}}}}$$

and is largest when V_{IN1} is at its minimum value if V_{OUT1} and I_{OUT1} are constant. With a 1.5A current limit, the maximum that the output current ripple can be is ~0.75A. Table 2 lists several capacitor vendors.

Buck Input Capacitor Selection

Bypass the input of the LT3570 circuit with a 10µF or higher ceramic capacitor of X7R or X5R type. A lower value or a less expensive Y5V type will work if there is additional bypassing provided by bulk electrolytic capacitors, or if the input source impedance is low. The following paragraphs describe the input capacitor considerations in more detail.

Step-down regulators draw current from the input supply in pulses with very fast rise and fall times. The input capacitor is required to reduce the resulting voltage ripple at the LT3570 input and to force this switching current

APPLICATIONS INFORMATION

into a tight local loop, minimizing EMI. The input capacitor must have low impedance at the switching frequency to do this effectively and it must have an adequate ripple current rating. The RMS input current is:

$$I_{IN2(RMS)} = I_{OUT2} \cdot \frac{\sqrt{V_{OUT2}(V_{IN2} - V_{OUT2})}}{V_{IN2}} < \frac{I_{OUT2}}{2}$$

and is largest when $V_{IN2} = 2 \cdot V_{OUT2}$ (50% duty cycle). Considering that the maximum load current is ~1.5A, RMS ripple current will always be less than 0.75A.

The high frequency of the LT3570 reduces the energy storage requirements of the input capacitor, so that the capacitance required is often less than 10µF. The combination of small size and low impedance (low equivalent series resistance or ESR) of ceramic capacitors makes them the preferred choice. The low ESR results in very low voltage ripple. Ceramic capacitors can handle larger magnitudes of ripple current than other capacitor types of the same value. Use X5R and X7R types.

An alternative to a high value ceramic capacitor is a lower value along with a larger electrolytic capacitor, for example a 1µF ceramic capacitor in parallel with a low ESR tantalum capacitor. For the electrolytic capacitor, a value larger than 10µF will be required to meet the ESR and ripple current requirements. Because the input capacitor is likely to see high surge currents when the input source is applied, tantalum capacitors should be surge rated. The manufacturer may also recommend operation below the rated voltage of the capacitor. Be sure to place the 1µF ceramic as close as possible to the V_{IN2} and GND pins on the IC for optimal noise immunity.

A final caution is in order regarding the use of ceramic capacitors at the input. A ceramic input capacitor can combine with stray inductance to form a resonant tank circuit. If power is applied quickly (for example by plugging the circuit into a live power source), this tank can ring, doubling the input voltage and damaging the LT3570. The solution is to either clamp the input voltage or dampen the tank circuit by adding a lossy capacitor in parallel with the ceramic capacitor. For details, see Application Note 88.

Boost Input Capacitor Selection

The capacitor of a boost converter is less critical due to the fact that the input current waveform is triangular and does not contain large squarewave currents as found in the output capacitor. Capacitors in the range of 10µF to 100µF with an ESR of 0.3Ω or less work well up to the full 1.5A switch current. Higher ESR capacitors may be acceptable at low switch currents. Input capacitor ripple current for boost converters is:

$$I_{RIPPLE} = 0.3 \cdot V_{IN1} \cdot \frac{V_{OUT1} - V_{IN1}}{f \cdot L \cdot V_{OUT1}}$$

Buck Diode Selection

The catch diode (D2 from Figure 1) conducts current only during switch-off time. Average forward current in normal operation can be calculated from:

$$I_{D(AVG)} = I_{OUT1} \cdot \frac{V_{IN1} - V_{OUT1}}{V_{IN1}}$$

The only reason to consider a diode with a larger current rating than necessary for nominal operation is for the worst-case condition of shorted output. The diode current will then increase to the typical peak switch current.

Peak reverse voltage is equal to the regulator input voltage. Use a diode with a reverse voltage rating greater than the input voltage. Table 3 lists several Schottky diodes and their manufacturers.

Table 3. Schottky Diodes

PART NUMBER	V _R (V)	I _{AVE} (A)	V _F AT 1A (mV)
On Semiconductor			
MBRM120E	20	1	530
MBRM140	40	1	550
Diodes Inc.			
B120	20	1	500
B130	30	1	500
International Rectifier			
10BQ030	30	1	420

APPLICATIONS INFORMATION

Boost Diode Selection

A Schottky diode is recommended for use with the LT3570 inverter/boost regulator. The Microsemi UPS120 is a very good choice. Where the input to output voltage differential exceeds 20V, use the UPS140 (a 40V diode). These diodes are rated to handle an average forward current of 1A. For applications where the average forward current of the diode is less than 0.5A, use an ON Semiconductor MBR0520L diode.

BOOST Pin Considerations

The capacitor and diode tied to the BOOST pin generate a voltage that is higher than the input voltage. In most cases, a 0.1 μ F capacitor and fast switching diode (such as the CMDSH-3 or MMSD914LT1) will work well. Figure 2 shows three ways to arrange the boost circuit. The BOOST pin must be more than 2.5V above the SW pin for full efficiency. For outputs of 3.3V and higher, the standard circuit (Figure 2a) is best. For outputs between 2.8V and 3.3V, use a small Schottky diode (such as the BAT-54). For lower output voltages, the boost diode can be tied to the input (Figure 2b). The circuit in Figure 2a is more efficient because the BOOST pin current comes from a lower voltage source. Finally, as shown in Figure 2c, the anode of the boost diode can be tied to another source that is at least 3V. For example, if you are generating 3.3V and 1.8V and the 3.3V is on whenever the 1.8V is on, the 1.8V boost diode can be connected to the 3.3V output. In any case, be sure that the maximum voltage at the BOOST pin is less than 60V and the voltage difference between the BOOST and SW2 pins is less than 25V.

The minimum operating voltage of an LT3570 application is limited by the undervoltage lockout (2.5V) and by the maximum duty cycle. The boost circuit also limits the minimum input voltage for proper start-up. If the input voltage ramps slowly, or the LT3570 turns on when the output is already in regulation, the boost capacitor may not be fully charged. Because the boost capacitor charges with the energy stored in the inductor, the circuit will rely on some minimum load current to get the boost circuit running properly. This minimum load will depend on input and output voltages, and on the arrangement of the boost circuit. The minimum load current generally goes to zero

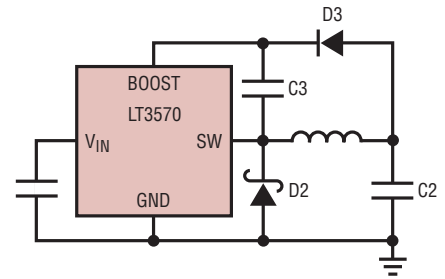

(2a)

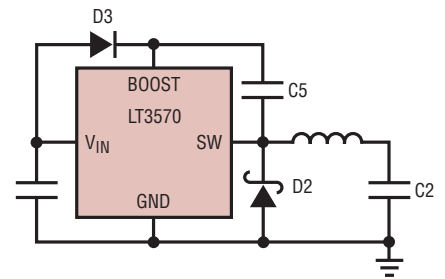

(2b)

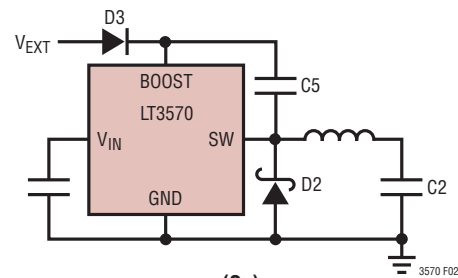

(2c)

Figure 2. Boost Pin Configurations

once the circuit has started. Even without an output load current, in many cases the discharged output capacitor will present a load to the switcher that will allow it to start.

Switcher Frequency Compensation

The LT3570 uses current mode control to regulate the output. This simplifies loop compensation. In particular, the LT3570 does not depend on the ESR of the output capacitor for stability so you are free to use ceramic capacitors to achieve low output ripple and small circuit size.

To compensate the feedback loop of the LT3570, a series resistor-capacitor network should be connected from the V_C pin to GND. For most applications, a capacitor in the range of 500pF to 4.7nF will suffice. A good starting value for the compensation capacitor, C_C , is 1nF. The

APPLICATIONS INFORMATION

compensation resistor, R_C , is usually in the range of 5k to 50k. A good technique to compensate a new application is to use a 50k potentiometer in place of R_C , and use a 1nF capacitor for C_C . By adjusting the potentiometer while observing the transient response, the optimum value for R_C can be found. Figures 3a to 3c illustrate this process for the circuit of Figure 1 with load current stepped from 100mA to 500mA for the buck converter. Figure 3a shows the transient response with R_C equal to 1.6k. The phase margin is poor as evidenced by the excessive ringing in the output voltage and inductor current. In Figure 3b, the value of R_C is increased to 5.75k, which results in a more damped response. Figure 3c shows the result when R_C is increased further to 25k. The transient response is nicely damped and the compensation procedure is complete. The same procedure is used to compensate the boost converter.

Soft-Start

The soft-start time is programmed with an external capacitor to ground on SS. An internal current source charges it with a nominal 4.5 μ A. The voltage on the soft-start pin is used to control the feedback voltage. The soft-start time is determined by the equation:

$$t_{SS} = 0.2 \cdot C_{SS}$$

where C_{SS} is in nF and t_{SS} is in ms. In the event of a commanded shutdown, ULVO on the input or a thermal shutdown, the capacitor is discharged automatically. The soft-start will remain low and only charge back up after the fault goes away and the voltage on SS is less than approximately 100mV.

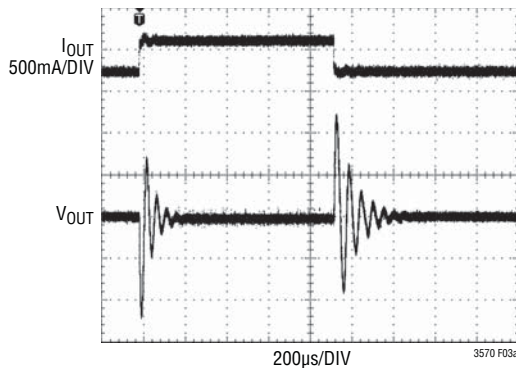

Figure 3a. Transient Response Shows Excessive Ringing

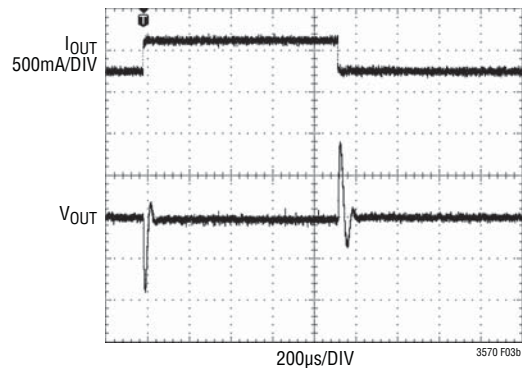

Figure 3b. Transient Response is Better

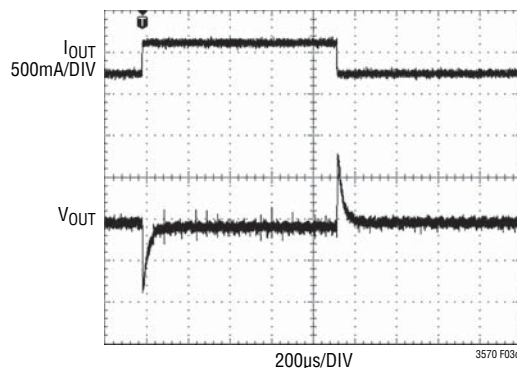

Figure 3c. Transient Response Well Damped

APPLICATIONS INFORMATION

Oscillator

The free-running frequency is set through a resistor from the R_T pin to ground. The oscillator frequency vs R_T can be seen in Figure 4. The oscillator can be synchronized with an external clock applied to the SYNC pin. When synchronizing the oscillator, the free running frequency must be set approximately 10% lower than the desired synchronized frequency.

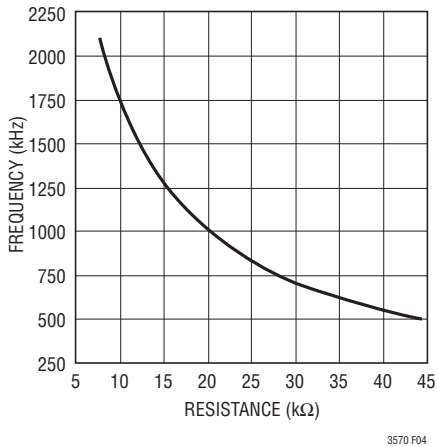

Figure 4. Frequency vs R_T Resistance

Buck Regulator Minimum On-Time

As the input voltage is increased, the LT3570 is required to turn on for shorter periods of time. Delays associated with turning off the power switch determine the minimum on-time that can be achieved and limit the minimum duty cycle. Figure 5 shows the minimum duty cycle versus frequency for the LT3570. When the required on-time has decreased below the minimum on-time of the LT3570 the inductor current will increase, exceeding the current limit. If the current through the inductor exceeds the current limit of the LT3570, the switch is prevented from turning on for 10μs allowing the inductor current to decrease. The 10μs off-time limits the average current that can be delivered to the load. To return to normal switching frequency either the input voltage or load current must decrease.

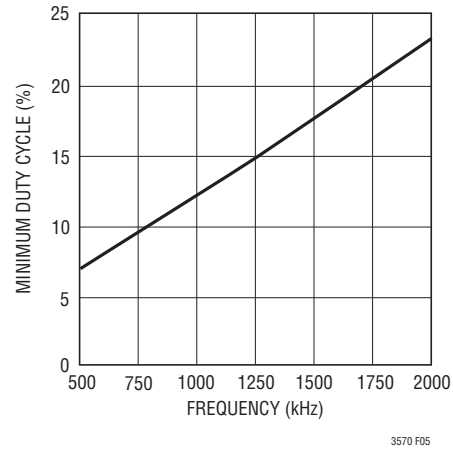

Figure 5. Minimum Duty Cycle vs Frequency

LDO Regulator

The LT3570 LDO regulator is capable of delivering up to 10mA of base drive for an external NPN transistor. For stable operation the total output capacitance can be from 1μF up to 100μF. The regulator has its own independent supply voltage which allows for the base of the NPN to be driven from a higher voltage than its collector. This allows for the NPN regulator to run more efficiently. The power Dissipated in the external NPN is equal to:

$$P_{DISS} = (V_{COL} - V_{OUT3}) \cdot I_{LOAD}$$

where V_{COL} is the collector voltage of the NPN. The maximum output voltage is limited to:

$$V_{IN3} - 1.4V \text{ and } V_{COL} - 0.2V \text{ or } 8V$$

The short-circuit protection of the NPN regulator is set by the max output current of the NPN_DRV pin multiplied by the beta of the NPN.

Thermal Shutdown

An internal temperature monitor will turn off the internal circuitry and prevent the switches from turning on when the die temperature reaches approximately 160°C. When the die temperature has dropped below this value the part

APPLICATIONS INFORMATION

will be enabled again going through a soft-start cycle. Note: Overtemperature protection is intended to protect the device during momentary overload conditions. Continuous operation above the specified maximum operating junction temperature may result in device degradation or failure.

PCB Layout

For proper operation and minimum EMI, care must be taken during printed circuit board (PCB) layout. Figure 6 shows the high current paths in the step-down regulator circuit. Note that in the step-down regulator, large switched currents flow in the power switch, the catch diode and the input capacitor.

Figure 7 shows the high current paths in the step-up regulator. In the boost regulator, large switched currents flow through the power switch, the switching diode, and the output capacitor.

The loop formed by these large switched current components should be as small as possible. Place these components on the same side of the circuit board and connect them on that layer. Place a local, unbroken ground plane below these components and tie this ground plane

to system ground at one location. Additionally, keep the SW and BOOST nodes as small as possible. This is implemented in the suggested layout of Figure 8 for the QFN package which shows the topside metal from the DC1106A demonstration board.

Thermal Considerations

To deliver the power that the LT3570 is capable of, it is imperative that a good thermal path be provided to dissipate the heat generated within the package. This can be accomplished by taking advantage of the large thermal pad on the underside of the IC. It is recommended that multiple vias in the printed circuit board be used to conduct heat away from the IC and into a copper plane with as much area as possible.

Related Linear Technology Publications

Application notes 19, 35, 44, 76 and 88 contain more detailed descriptions and design information for buck regulators and other switching regulators. The LT1375 data sheet has a more extensive discussion of output ripple, loop compensation, and stability testing.

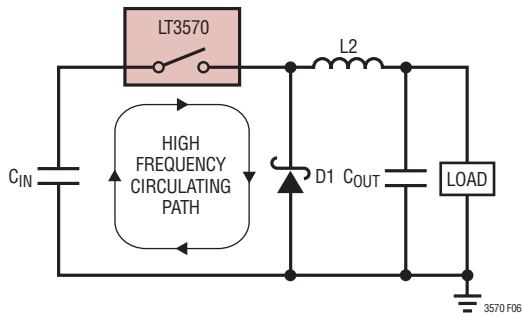

Figure 6. Buck High Speed Switching Path

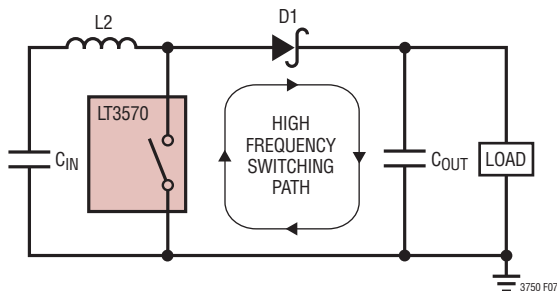

Figure 7. Boost High Speed Switching Path

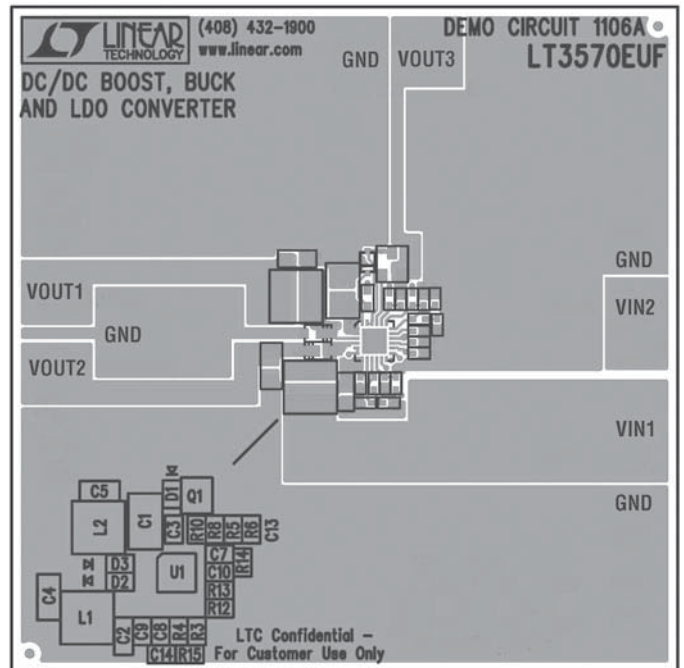
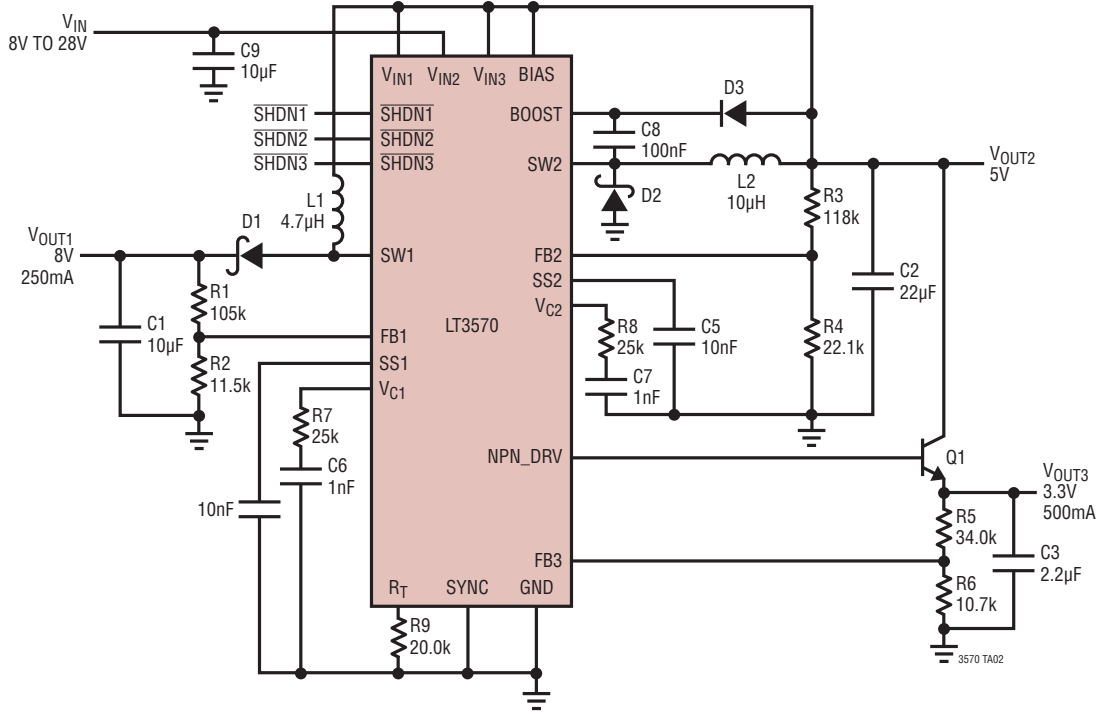

Figure 8. Suggested Layout

TYPICAL APPLICATIONS

DSL Modem



“Dying Gasp” System

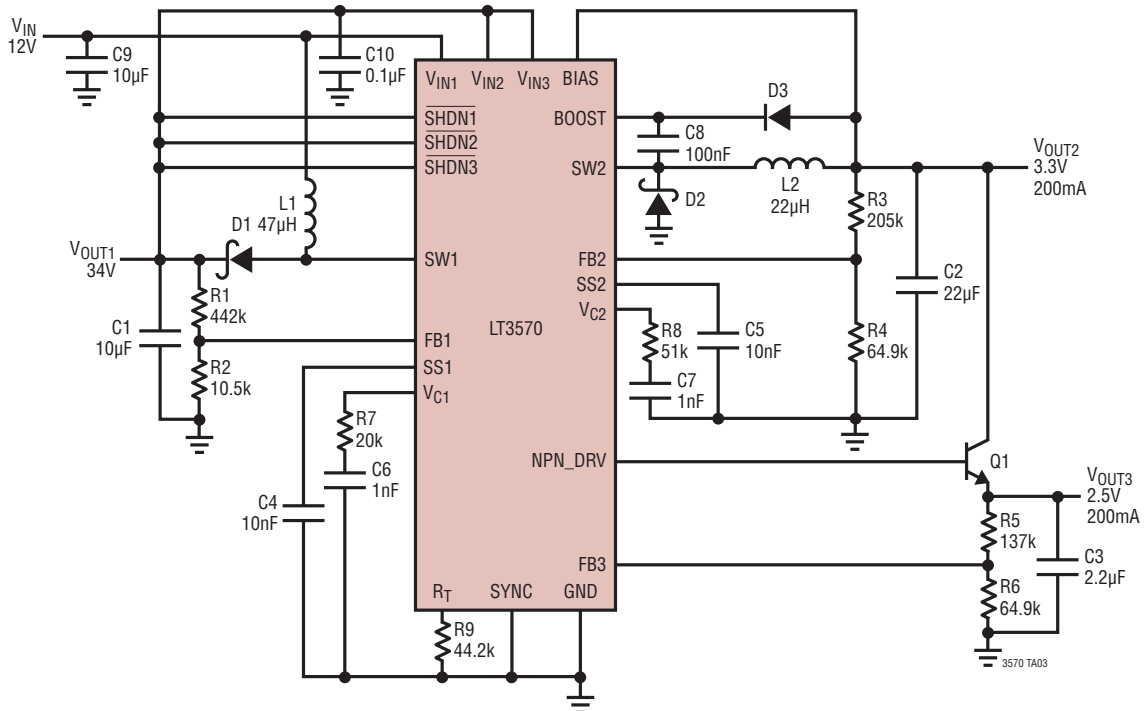

PACKAGE DESCRIPTION

UF Package 24-Lead Plastic QFN (4mm × 4mm) (Reference LTC DWG # 05-08-1697)

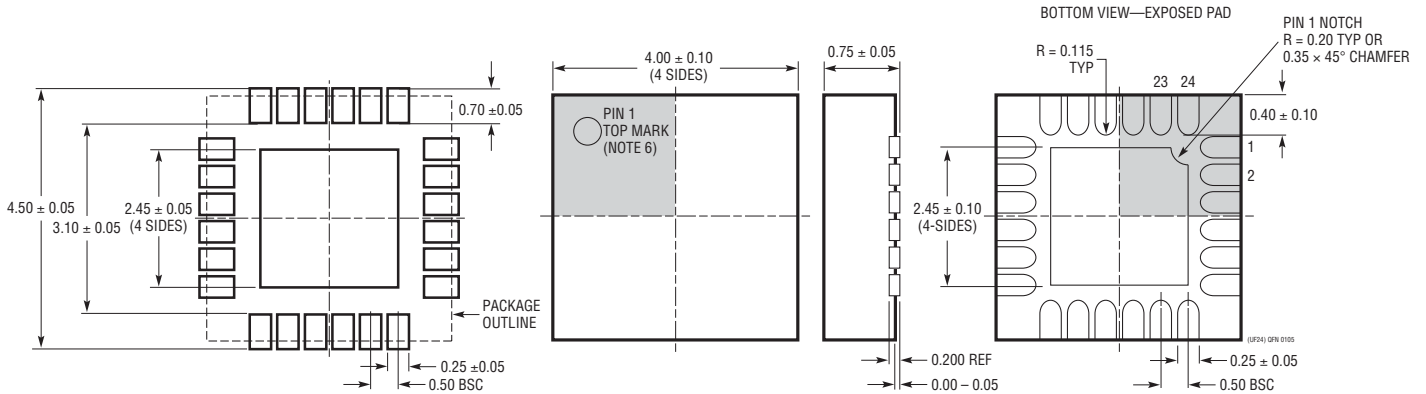

RECOMMENDED SOLDER PAD PITCH AND DIMENSIONS

- NOTE:
1. DRAWING PROPOSED TO BE MADE A JEDEC PACKAGE OUTLINE MO-220 VARIATION (WGGD-X)—TO BE APPROVED
 2. DRAWING NOT TO SCALE
 3. ALL DIMENSIONS ARE IN MILLIMETERS
 4. DIMENSIONS OF EXPOSED PAD ON BOTTOM OF PACKAGE DO NOT INCLUDE MOLD FLASH. MOLD FLASH, IF PRESENT, SHALL NOT EXCEED 0.15mm ON ANY SIDE, IF PRESENT
 5. EXPOSED PAD SHALL BE SOLDER PLATED
 6. SHADED AREA IS ONLY A REFERENCE FOR PIN 1 LOCATION ON THE TOP AND BOTTOM OF PACKAGE

FE Package 20-Lead Plastic TSSOP (4.4mm) (Reference LTC DWG # 05-08-1663) Exposed Pad Variation CB

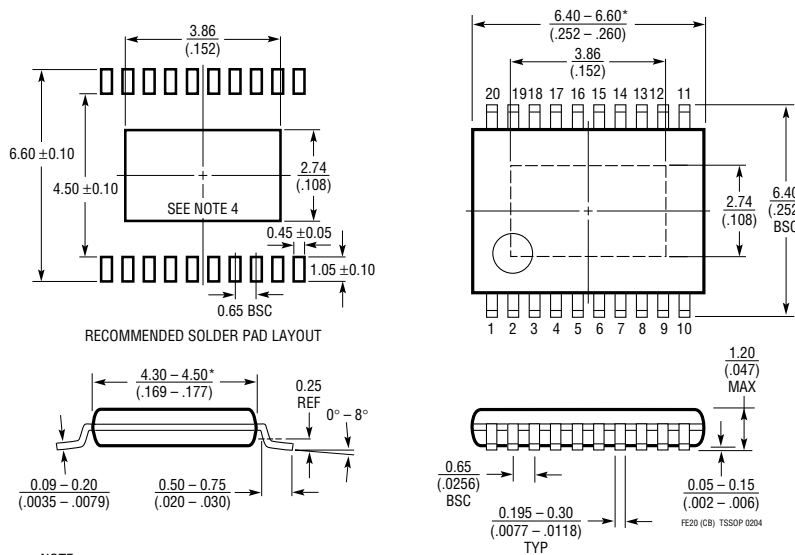

RECOMMENDED SOLDER PAD LAYOUT

- NOTE:
1. CONTROLLING DIMENSION: MILLIMETERS
 2. DIMENSIONS ARE IN MILLIMETERS (INCHES)
 3. DRAWING NOT TO SCALE
 4. RECOMMENDED MINIMUM PCB METAL SIZE FOR EXPOSED PAD ATTACHMENT
- *DIMENSIONS DO NOT INCLUDE MOLD FLASH. MOLD FLASH SHALL NOT EXCEED 0.150mm (.006") PER SIDE

TYPICAL APPLICATION

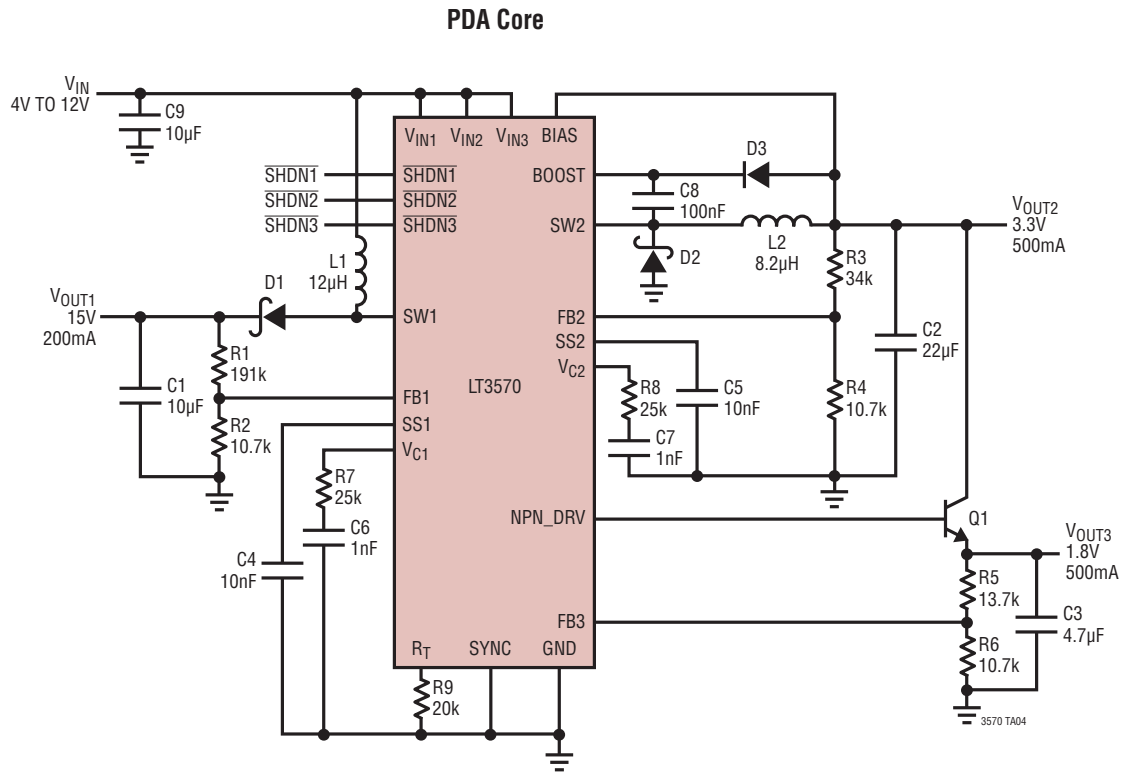

RELATED PARTS

PART NUMBER	DESCRIPTION	COMMENTS
LT1767	1.5A, 1.25MHz Step-Down Switching Regulator	3V to 25V Input, $V_{REF} = 1.2V$, Synchronizable Up to 2MHz, MSOP Package
LT1930/LT1930A	1A (I_{SW}), 1.2MHz/2.2MHz, High Efficiency Step-Up DC/DC Converter	V_{IN} : 2.6V to 16V, $V_{OUT(MAX)} = 34V$, $I_Q = 4.2mA/5.5mA$, $I_{SD} < 1\mu A$, ThinSOT™ Package
LT1939	25V, 2.4MHz Step-Down DC/DC Converter and LDO Controller	V_{IN} : 3V to 40V, $V_{OUT(MIN)} = 0.8V$, $I_Q = 2mA$, $I_{SD} < 1\mu A$, 3mm × 3mm DFN
LT1943	Quad Output, 2.6A Buck, 2.6A Boost, 0.3A Boost, 0.4A Inverter 1.2MHz TFT DC/DC Converter	V_{IN} : 4.5V to 22V, $V_{OUT(MAX)} = 40V$, $I_Q = 10mA$, $I_{SD} < 35\mu A$, TSSOP28E Package
LT1945	Dual Output Pos/Neg 350mA (I_{SW}), Constant Off-Time, High Efficiency Step-Up DC/DC Converter	V_{IN} : 1.2V to 15V, $V_{OUT(MAX)} = \pm 34V$, $I_Q = 20\mu A$, $I_{SD} < 1\mu A$, 10-Pin MS Package
LT3463	Dual Output Pos/Neg 250mA (I_{SW}), Constant Off-Time, High Efficiency Step-Up DC/DC Converter with Integrated Schottkys	V_{IN} : 2.4V to 15V, $V_{OUT(MAX)} = \pm 40V$, $I_Q = 40\mu A$, $I_{SD} < 1\mu A$, 3mm × 3mm DFN10 Package
LT3467	1.1A, 1.3MHz Step Up DC/DC Converter with Integrated Soft-Start	V_{IN} : 2.4V to 16V, $V_{OUT(MAX)} = 40V$, $I_{SD} < 1\mu A$, Low profile (1mm) SOT-23 Package
LT3500	40V, 2A, 2.4MHz Step-Down DC/DC Converter and LDO Controller	V_{IN} : 3V to 40V, $V_{OUT(MIN)} = 0.8V$, $I_Q = 2mA$, $I_{SD} < 1\mu A$, 3mm × 3mm DFN
LT3507	36V, 2.5MHz Triple (2.4A, 1.5A, 1.5A) Step-Down DC/DC Converter and LDO Controller	V_{IN} : 4V to 36V, $V_{OUT(MIN)} = 0.8V$, $I_Q = 7mA$, $I_{SD} < 1\mu A$, 5mm × 7mm QFN38 Package

ThinSOT is a trademark of Linear Technology Corporation.