

## FEATURES

- \* High current transfer ratio  
( CTR : MIN. 1000% at  $I_F = 1\text{mA}$ ,  $V_{CE} = 2\text{V}$  )
- \* High input-output isolation voltage  
(  $V_{iso} = 5,000\text{Vrms}$  )
- \* High collector-emitter voltage  
(  $V_{CEO} = 300\text{V}$  )
- \* Dual-in-line package :
  - LTV-852 : 1-channel type
  - LTV-8D52 : 2-channel type
- \* Wide lead spacing package :
  - LTV-852M : 1-channel type
  - LTV-8D52M : 2-channel type
- \* Surface mounting package :
  - LTV-852S : 1-channel type
  - LTV-8D52S : 2-channel type
- \* Tape and reel packaging :
  - LTV-852S-TA1, LTV-8D52S-TA1, LTV-852S-TA, LTV-8D52-TA
- \* UL approved ( No. E113898 )
- \* TUV approved ( No. R9653630 )
- \* CSA approved ( No. CA91533-1 )
- \* FIMKO approved ( No. 202944 )
- \* NEMKO approved ( No. P98101736 )
- \* DEMKO approved ( No. 307924 )
- \* SEMKO approved ( No. 9833166 / 01-20 )
- \* VDE approved ( No. 094722 )

## OUTLINE DIMENSIONS

### LTV-852 :

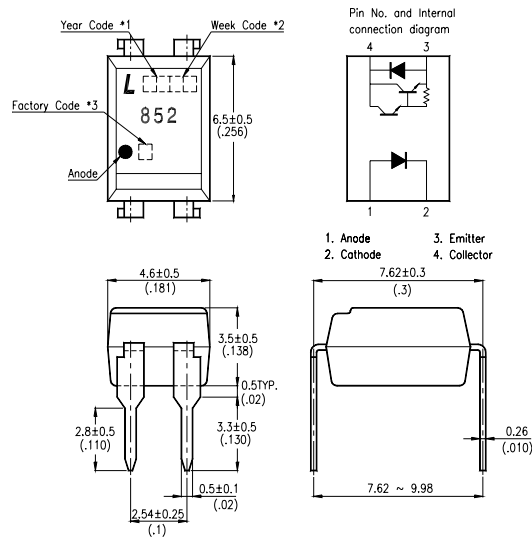

### LTV-8D52 :

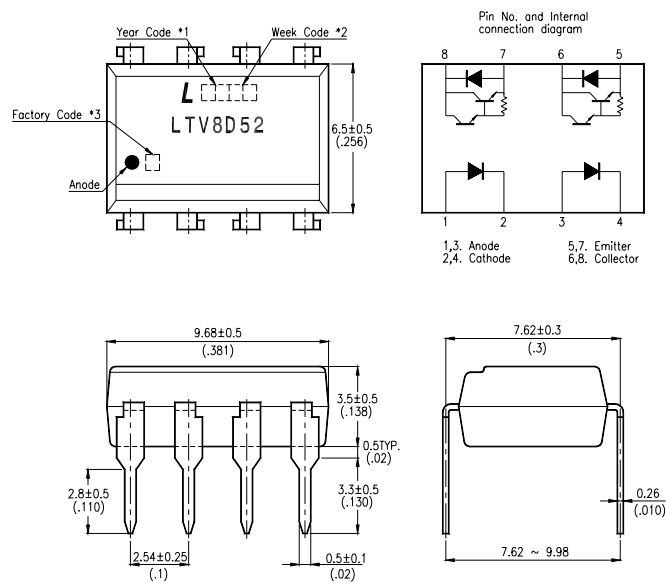

- \*1. Year date code.
- \*2. 2-digit work week.
- \*3. Factory identification mark shall be marked (Z : Taiwan, Y : Thailand, X : China).

## OUTLINE DIMENSIONS

### LTV-852M :

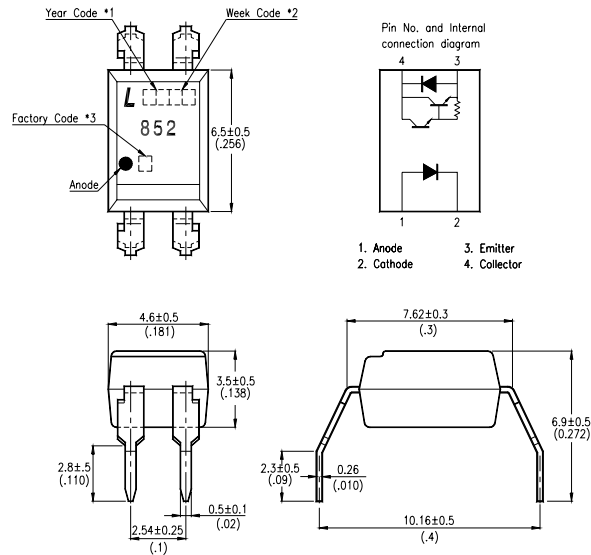

### LTV-8D52M :

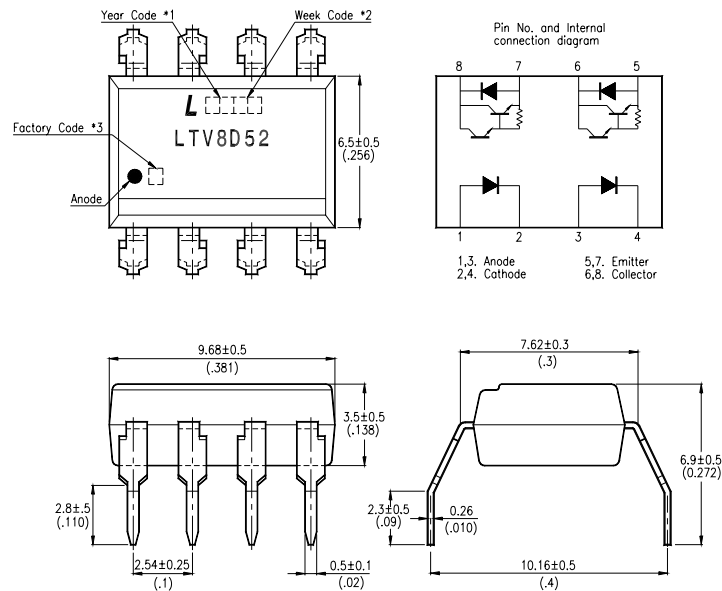

- \*1. Year date code.
- \*2. 2-digit work week.
- \*3. Factory identification mark shall be marked (Z : Taiwan, Y : Thailand, X : China).

## OUTLINE DIMENSIONS

### LTV-852S :

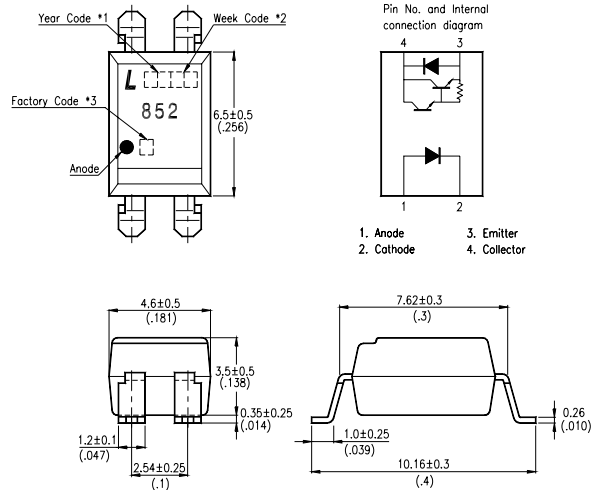

### LTV-8D52S :

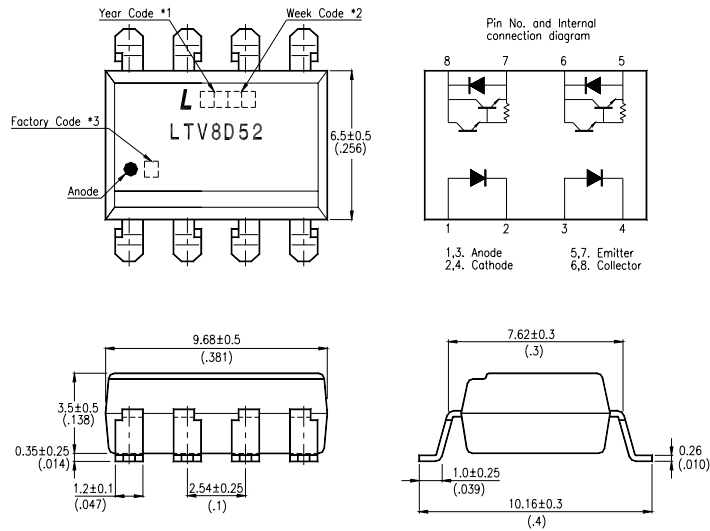

- \*1. Year date code.
- \*2. 2-digit work week.
- \*3. Factory identification mark shall be marked (Z : Taiwan, Y : Thailand, X : China).

## TAPING DIMENSIONS

### LTV-852S-TA1 :

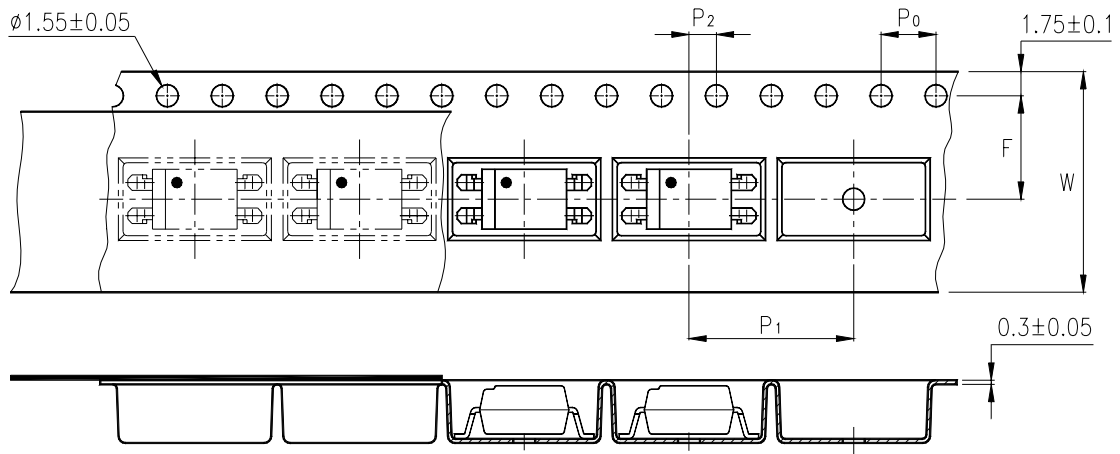

### LTV-8D52S-TA1 :

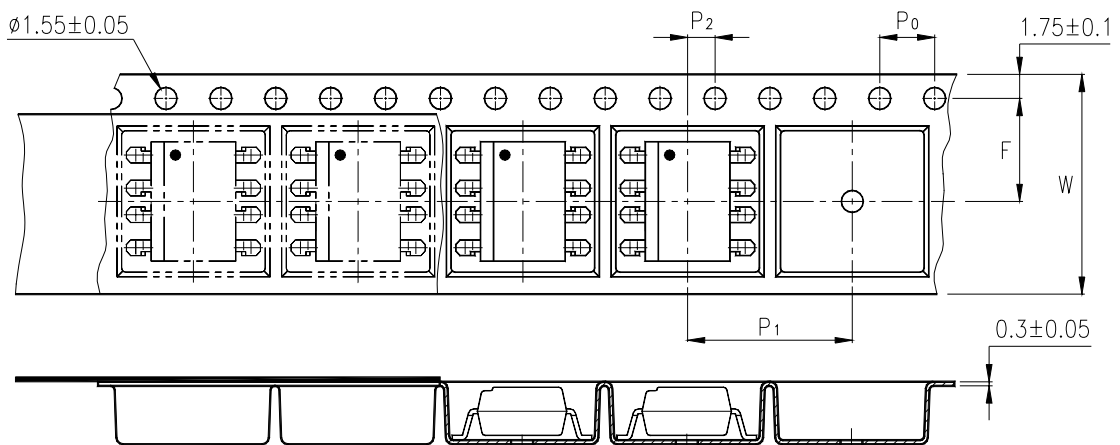

Description	Symbol	Dimensions in mm ( inches )
Tape wide	W	$16 \pm 0.3$ ( .63 )
Pitch of sprocket holes	$P_0$	$4 \pm 0.1$ ( .15 )
Distance of compartment	F	$7.5 \pm 0.1$ ( .295 )
	$P_2$	$2 \pm 0.1$ ( .079 )
Distance of compartment to compartment	$P_1$	$12 \pm 0.1$ ( .472 )

## TAPING DIMENSIONS

### LTV-852S-TA :

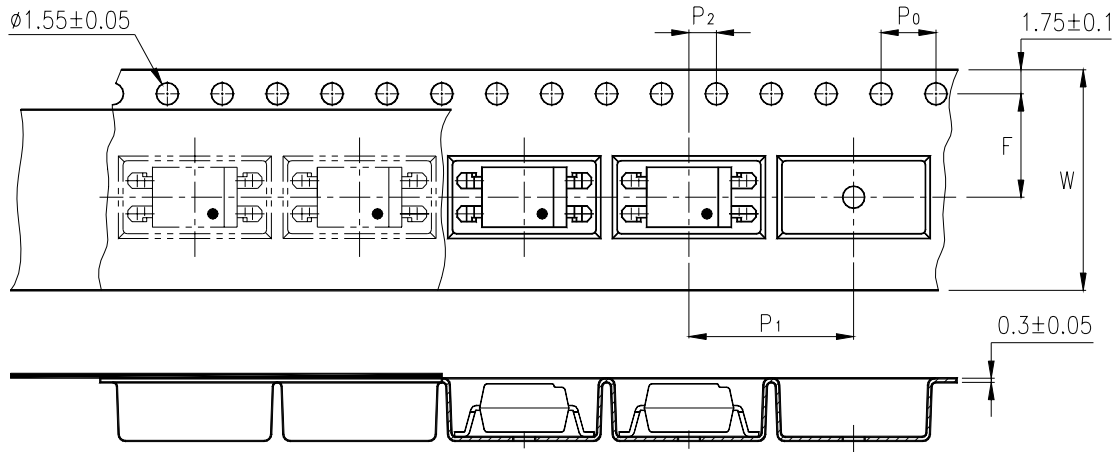

### LTV-8D52S-TA :

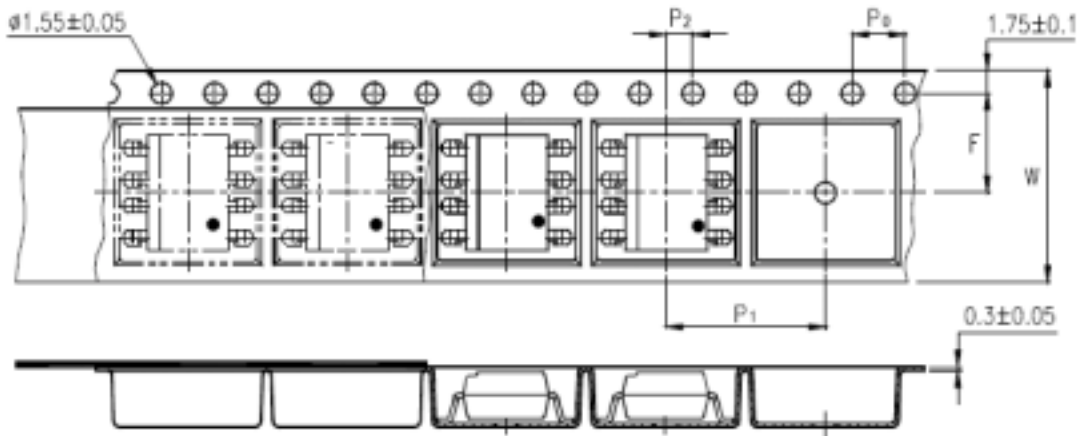

Description	Symbol	Dimensions in mm ( inches )
Tape wide	W	$16 \pm 0.3$ ( .63 )
Pitch of sprocket holes	$P_0$	$4 \pm 0.1$ ( .15 )
Distance of compartment	F	$7.5 \pm 0.1$ ( .295 )
	$P_2$	$2 \pm 0.1$ ( .079 )
Distance of compartment to compartment	$P_1$	$12 \pm 0.1$ ( .472 )

## ABSOLUTE MAXIMUM RATING

( Ta = 25°C )

PARAMETER		SYMBOL	RATING	UNIT
INPUT	Forward Current	I <sub>F</sub>	50	mA
	Reverse Voltage	V <sub>R</sub>	6	V
	Power Dissipation	P	70	mW
OUTPUT	Collector - Emitter Voltage	V <sub>CEO</sub>	300	V
	Emitter - Collector Voltage	V <sub>ECO</sub>	0.1	V
	Collector Current	I <sub>C</sub>	150	mA
	Collector Power Dissipation	P <sub>C</sub>	150	mW
Total Power Dissipation		P <sub>tot</sub>	200	mW
*1	Isolation Voltage	V <sub>iso</sub>	5,000	V <sub>rms</sub>
Operating Temperature		T <sub>opr</sub>	-30 ~ +100	°C
Storage Temperature		T <sub>stg</sub>	-55 ~ +125	°C
*2	Soldering Temperature	T <sub>sol</sub>	260	°C

\*1. AC For 1 Minute, R.H. = 40 ~ 60%

Isolation voltage shall be measured using the following method.

- (1) Short between anode and cathode on the primary side and between collector and emitter on the secondary side.
- (2) The isolation voltage tester with zero-cross circuit shall be used.
- (3) The waveform of applied voltage shall be a sine wave.

\*2. For 10 Seconds

### ELECTRICAL - OPTICAL CHARACTERISTICS

( Ta = 25°C )

PARAMETER		SYMBOL	MIN.	TYP.	MAX.	UNIT	CONDITIONS
INPUT	Forward Voltage	V <sub>F</sub>	—	1.2	1.4	V	I <sub>F</sub> =10mA
	Reverse Current	I <sub>R</sub>	—	—	10	μA	V <sub>R</sub> =4V
	Terminal Capacitance	C <sub>t</sub>	—	30	250	pF	V=0, f=1KHz
OUTPUT	Collector Dark Current	I <sub>CEO</sub>	—	—	200	nA	V <sub>CE</sub> =200V, I <sub>F</sub> =0
	Collector-Emitter Breakdown Voltage	BV <sub>CEO</sub>	300	—	—	V	I <sub>C</sub> =0.1mA I <sub>F</sub> =0
	Emitter-Collector Breakdown Voltage	BV <sub>ECO</sub>	0.1	—	—	V	I <sub>E</sub> =10μA I <sub>F</sub> =0
TRANSFER CHARACTERISTICS	Collector Current	I <sub>C</sub>	10	40	150	mA	I <sub>F</sub> =1mA V <sub>CE</sub> =2V
	*1 Current Transfer Ratio	CTR	1,000	4,000	15,000	%	
	Collector-Emitter Saturation Voltage	V <sub>CE(sat)</sub>	—	—	1.2	V	I <sub>F</sub> =20mA I <sub>C</sub> =100mA
	Isolation Resistance	R <sub>iso</sub>	5×10 <sup>10</sup>	1×10 <sup>11</sup>	—	Ω	DC500V 40 ~ 60% R.H.
	Floating Capacitance	C <sub>f</sub>	—	0.6	1	pF	V=0, f=1MHz
	Cut-Off Frequency	f <sub>c</sub>	1	7	—	kHz	V <sub>CE</sub> =2V, I <sub>C</sub> =20mA R <sub>L</sub> =100Ω, -3dB
	Response Time (Rise)	t <sub>r</sub>	—	100	300	μs	V <sub>CC</sub> =2V, I <sub>C</sub> =20mA R <sub>L</sub> =100Ω
Response Time (Fall)	t <sub>f</sub>	—	20	100	μs		

$$*1 \text{ CTR} = \frac{I_C}{I_F} \times 100\%$$



### CHARACTERISTICS CURVES

Fig.1 Forward Current vs. Ambient Temperature

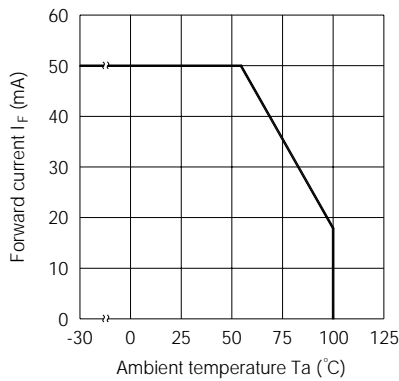

Fig.2 Collector Power Dissipation vs. Ambient Temperature

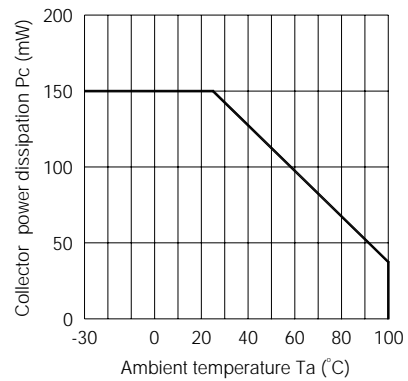

Fig.3 Collector-emitter saturation Voltage vs. Forward current

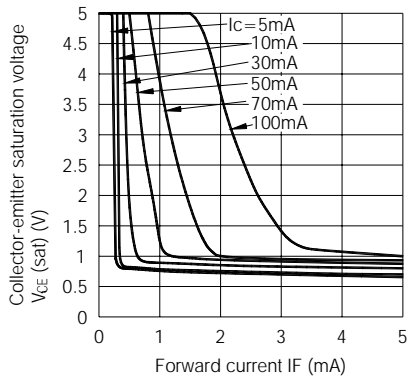

Fig.4 Forward Current vs. Forward Voltage

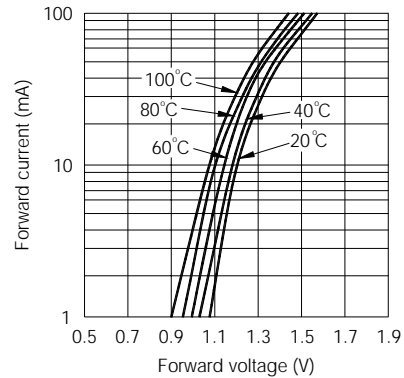

Fig.5 Current Transfer Ratio vs. Forward Current

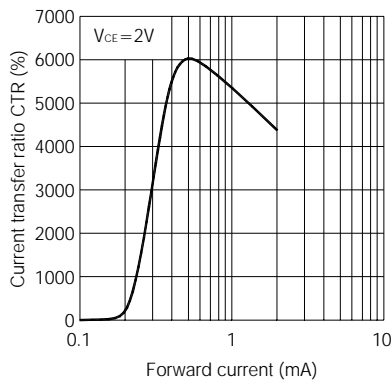
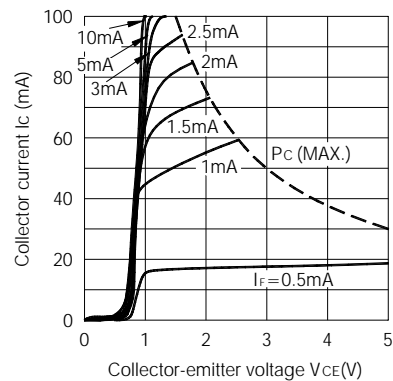

Fig.6 Collector Current vs. Collector-emitter Voltage



## CHARACTERISTICS CURVES

Fig.7 Relative Current Transfer Ratio vs. Ambient Temperature

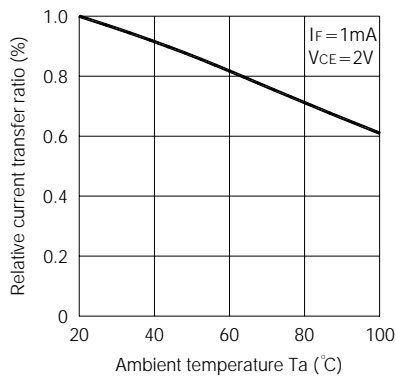

Fig.8 Collector-emitter Saturation Voltage vs. Ambient Temperature

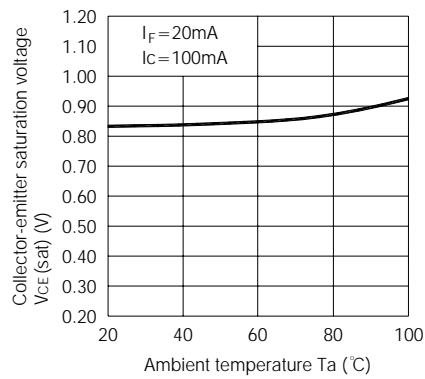

Fig.9 Collector Dark Current vs. Temperature

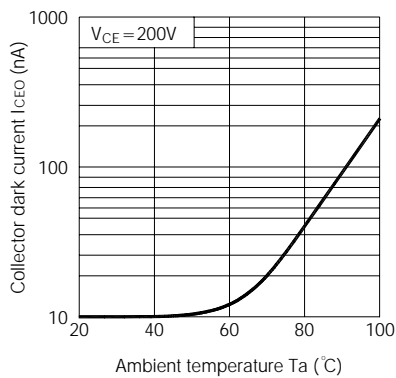

Fig.10 Response Time vs. Load Resistance

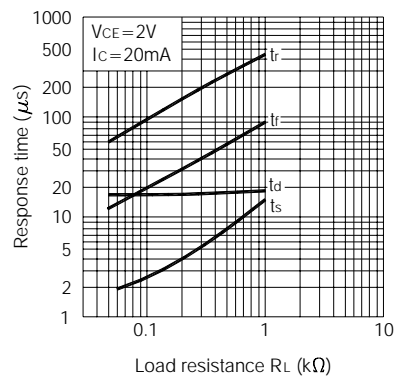
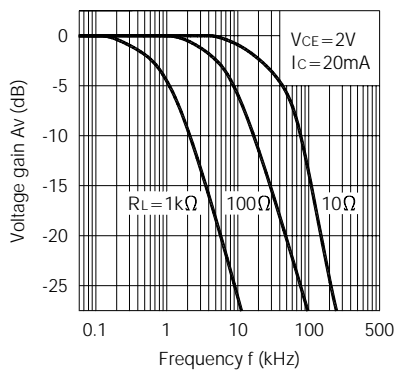
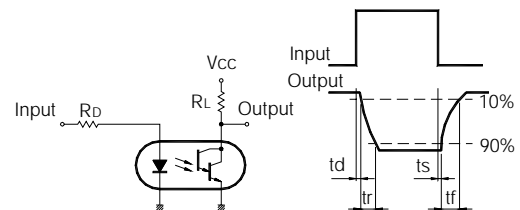

Fig.11 Frequency Response



Test Circuit for Response Time



Test Circuit for Frequency Response

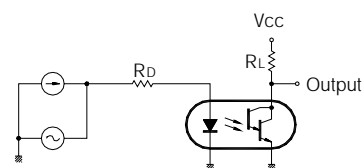

## RECOMMENDED FOOT PRINT PATTERNS (MOUNT PAD)

Unit : mm

4 PIN

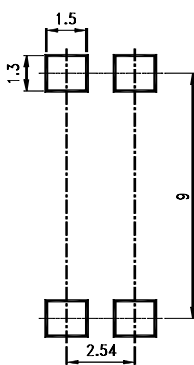

8 PIN

