



FEATURES

- * High current transfer ratio
(CTR : MIN. 1000% at $I_F = 1\text{mA}$, $V_{CE} = 2\text{V}$)
- * High input-output isolation voltage
($V_{iso} = 5,000\text{Vrms}$)
- * High collector-emitter voltage
($V_{CEO} = 300\text{V}$)
- * Dual-in-line package :
 - LTV-852 : 1-channel type
 - LTV-8D52 : 2-channel type
- * Wide lead spacing package :
 - LTV-852M : 1-channel type
 - LTV-8D52M : 2-channel type
- * Surface mounting package :
 - LTV-852S : 1-channel type
 - LTV-8D52S : 2-channel type
- * Tape and reel packaging :
 - LTV-852S-TA1, LTV-8D52S-TA1
- * UL approved (No. E113898)
- * TUV approved (No. R9653630)
- * CSA approved (No. CA91533-1)
- * FIMKO approved (No. 202944)
- * NEMKO approved (No. P98101736)
- * DEMKO approved (No. 307924)
- * SEMKO approved (No. 9833166 / 01-20)
- * VDE approved (No. 094722)

OUTLINE DIMENSIONS

LTV-852 :

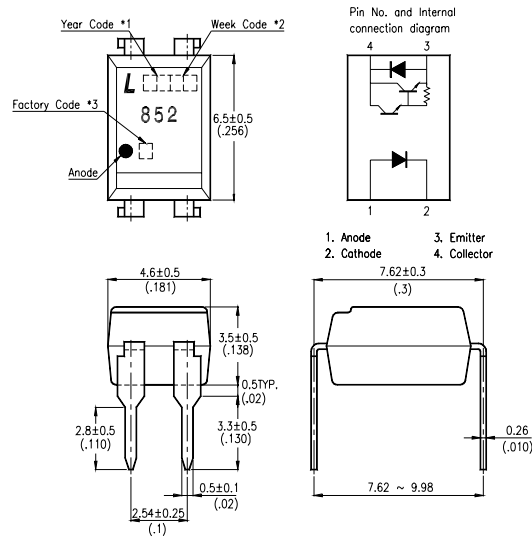

LTV-8D52 :

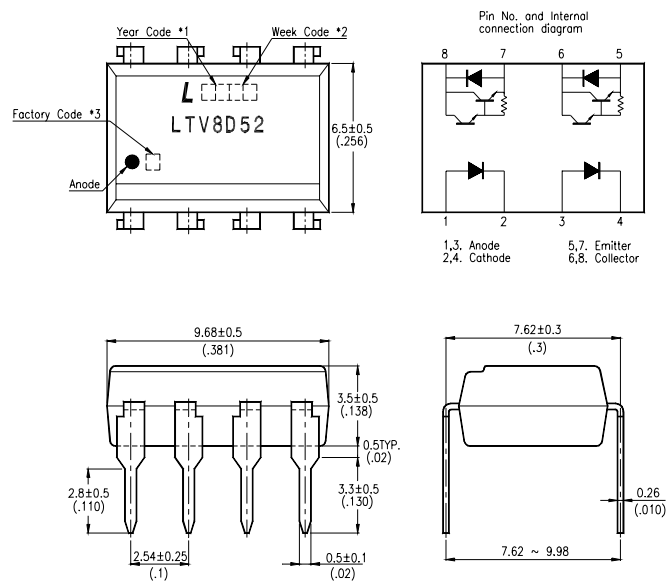

- *1. Year date code.
- *2. 2-digit work week.
- *3. Factory identification mark shall be marked (Z : Taiwan, Y : Thailand, X : China).

OUTLINE DIMENSIONS

LTV-852M :

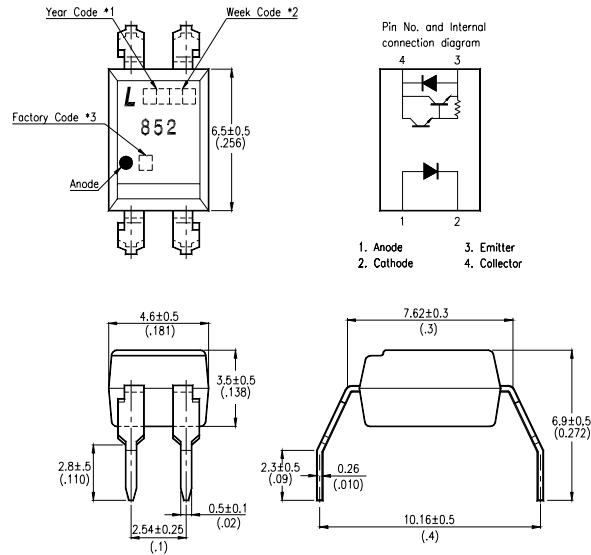

LTV-8D52M :

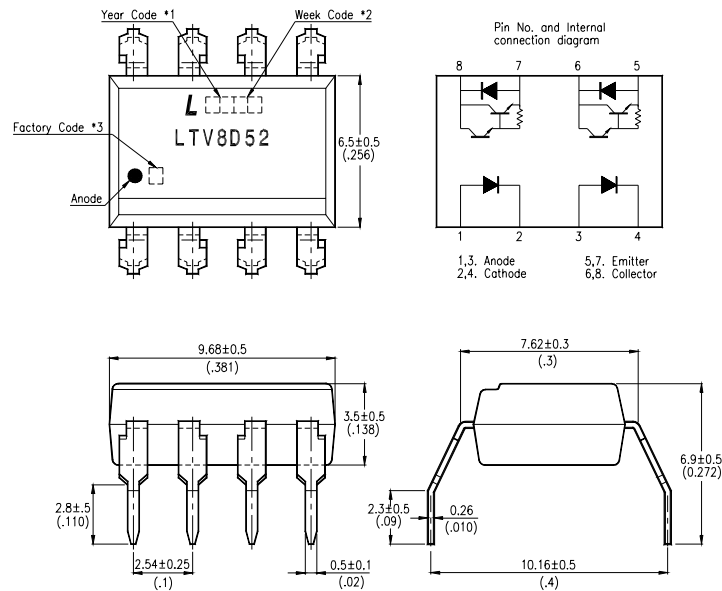

- *1. Year date code.
- *2. 2-digit work week.
- *3. Factory identification mark shall be marked (Z : Taiwan, Y : Thailand, X : China).

OUTLINE DIMENSIONS

LTV-852S :

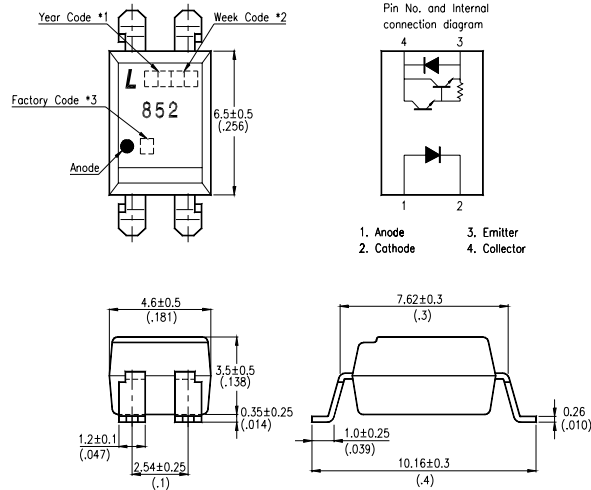

LTV-8D52S :

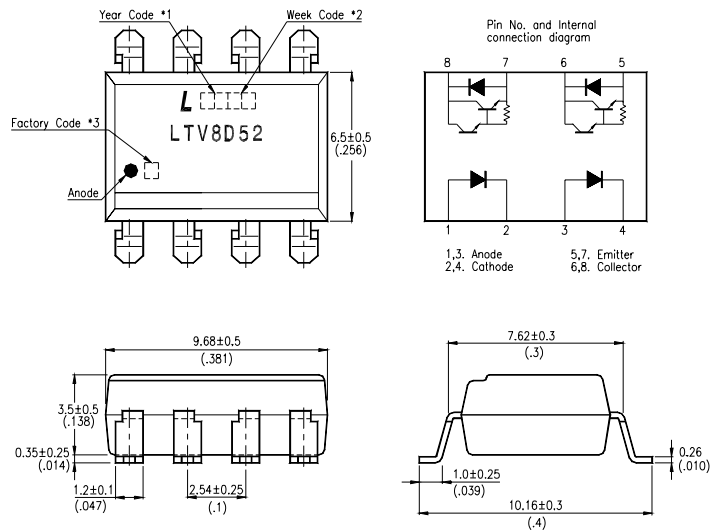

- *1. Year date code.
- *2. 2-digit work week.
- *3. Factory identification mark shall be marked (Z : Taiwan, Y : Thailand, X : China).

TAPING DIMENSIONS

LTV-852S-TA1 :

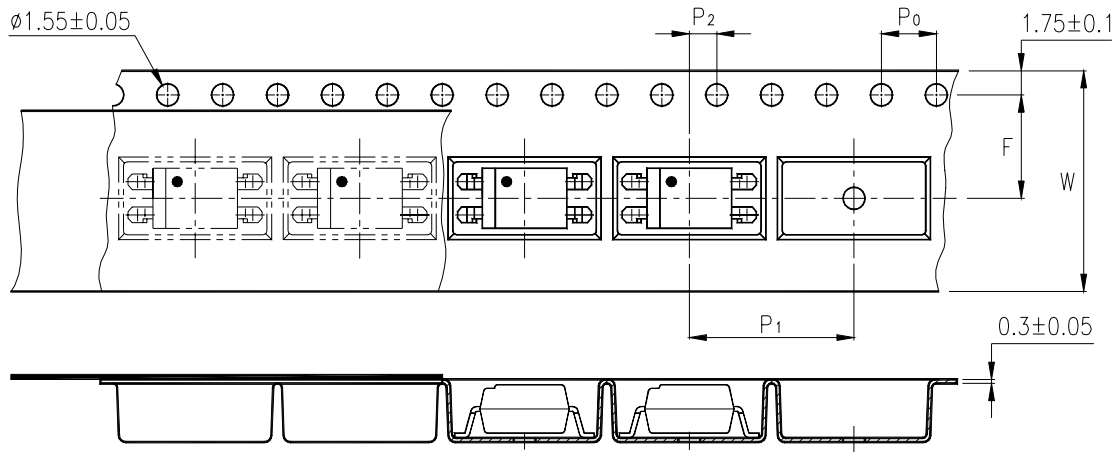

LTV-8D52S-TA1 :

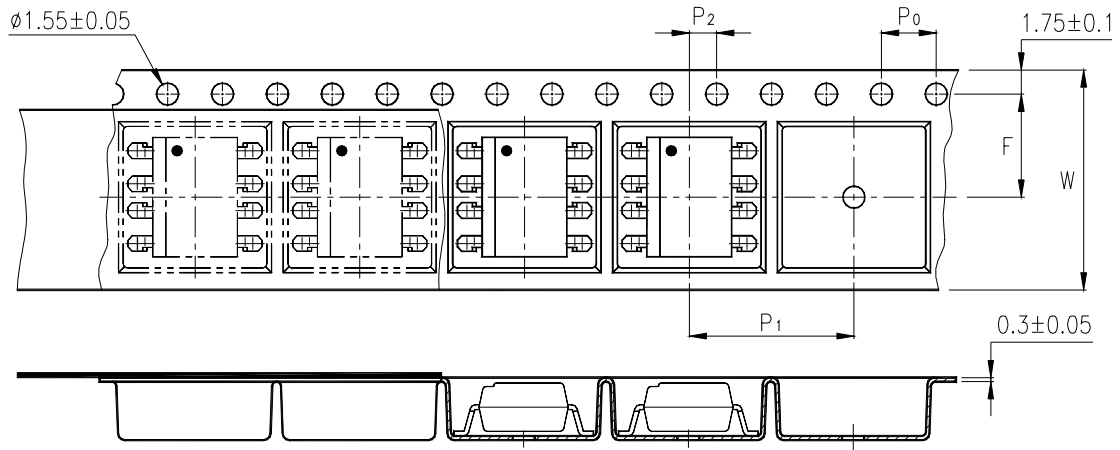

| Description | Symbol | Dimensions in mm (inches) |
|--|--------|-----------------------------|
| Tape wide | W | 16 ± 0.3 (.63) |
| Pitch of sprocket holes | P_0 | 4 ± 0.1 (.15) |
| Distance of compartment | F | 7.5 ± 0.1 (.295) |
| Distance of compartment to compartment | P_1 | 2 ± 0.1 (.079) |
| Distance of compartment to compartment | P_2 | 12 ± 0.1 (.472) |

ABSOLUTE MAXIMUM RATING

(Ta = 25°C)

| PARAMETER | | SYMBOL | RATING | UNIT |
|-------------------------|-----------------------------|------------------|------------|------------------|
| INPUT | Forward Current | I _F | 50 | mA |
| | Reverse Voltage | V _R | 6 | V |
| | Power Dissipation | P | 70 | mW |
| OUTPUT | Collector - Emitter Voltage | V _{CEO} | 300 | V |
| | Emitter - Collector Voltage | V _{ECO} | 0.1 | V |
| | Collector Current | I _C | 150 | mA |
| | Collector Power Dissipation | P _C | 150 | mW |
| Total Power Dissipation | | P _{tot} | 200 | mW |
| *1 | Isolation Voltage | V _{iso} | 5,000 | V _{rms} |
| Operating Temperature | | T _{opr} | -30 ~ +100 | °C |
| Storage Temperature | | T _{stg} | -55 ~ +125 | °C |
| *2 | Soldering Temperature | T _{sol} | 260 | °C |

*1. AC For 1 Minute, R.H. = 40 ~ 60%

Isolation voltage shall be measured using the following method.

- (1) Short between anode and cathode on the primary side and between collector and emitter on the secondary side.
- (2) The isolation voltage tester with zero-cross circuit shall be used.
- (3) The waveform of applied voltage shall be a sine wave.

*2. For 10 Seconds

ELECTRICAL - OPTICAL CHARACTERISTICS

(Ta = 25°C)

| PARAMETER | | SYMBOL | MIN. | TYP. | MAX. | UNIT | CONDITIONS |
|--------------------------|--------------------------------------|----------------------|--------------------|--------------------|--------|------|---|
| INPUT | Forward Voltage | V _F | — | 1.2 | 1.4 | V | I _F =10mA |
| | Reverse Current | I _R | — | — | 10 | μA | V _R =4V |
| | Terminal Capacitance | C _t | — | 30 | 250 | pF | V=0, f=1KHz |
| OUTPUT | Collector Dark Current | I _{CEO} | — | — | 200 | nA | V _{CE} =200V, I _F =0 |
| | Collector-Emitter Breakdown Voltage | BV _{CEO} | 300 | — | — | V | I _C =0.1mA I _F =0 |
| | Emitter-Collector Breakdown Voltage | BV _{ECO} | 0.1 | — | — | V | I _E =10μA I _F =0 |
| TRANSFER CHARACTERISTICS | Collector Current | I _C | 10 | 40 | 150 | mA | I _F =1mA V _{CE} =2V |
| | *1 Current Transfer Ratio | CTR | 1,000 | 4,000 | 15,000 | % | |
| | Collector-Emitter Saturation Voltage | V _{CE(sat)} | — | — | 1.2 | V | I _F =20mA I _C =100mA |
| | Isolation Resistance | R _{iso} | 5×10 ¹⁰ | 1×10 ¹¹ | — | Ω | DC500V 40 ~ 60% R.H. |
| | Floating Capacitance | C _f | — | 0.6 | 1 | pF | V=0, f=1MHz |
| | Cut-Off Frequency | f _c | 1 | 7 | — | kHz | V _{CE} =2V, I _C =20mA R _L =100Ω, -3dB |
| | Response Time (Rise) | t _r | — | 100 | 300 | μs | V _{CC} =2V, I _C =20mA R _L =100Ω |
| | Response Time (Fall) | t _f | — | 20 | 100 | μs | |

$$*1 \text{ CTR} = \frac{I_C}{I_F} \times 100\%$$

CHARACTERISTICS CURVES

Fig.1 Forward Current vs. Ambient Temperature

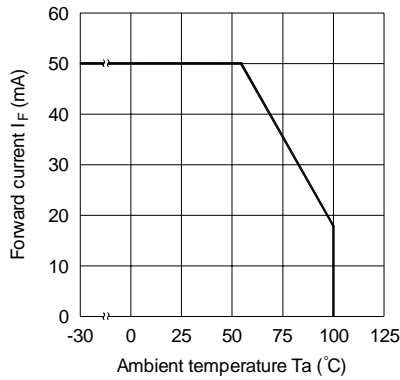

Fig.2 Collector Power Dissipation vs. Ambient Temperature

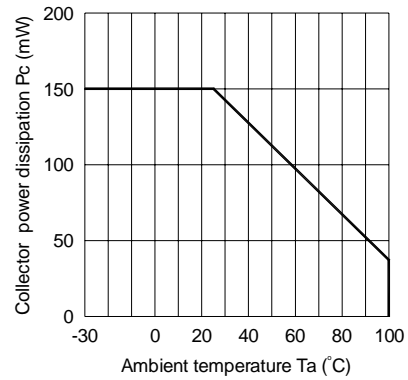

Fig.3 Collector-emitter saturation Voltage vs. Forward current

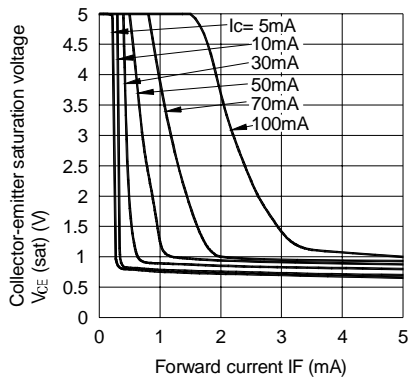

Fig.4 Forward Current vs. Forward Voltage

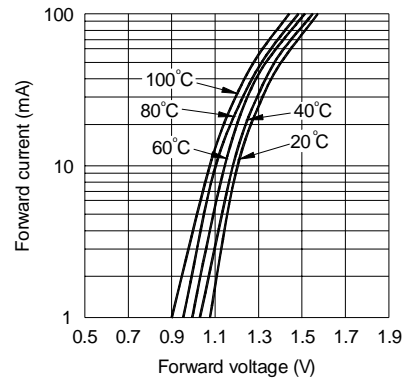

Fig.5 Current Transfer Ratio vs. Forward Current

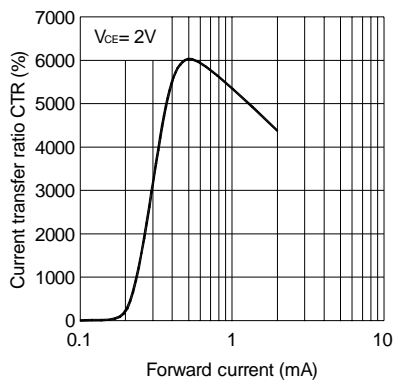
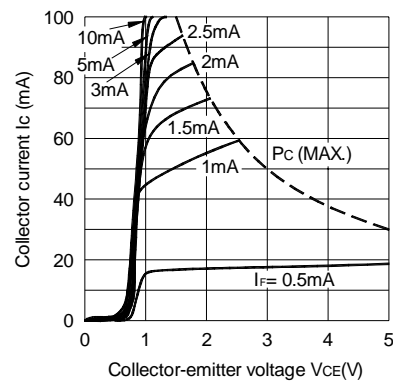

Fig.6 Collector Current vs. Collector-emitter Voltage



CHARACTERISTICS CURVES

Fig.7 Relative Current Transfer Ratio vs. Ambient Temperature

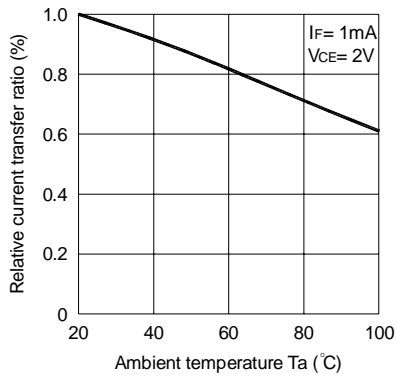

Fig.8 Collector-emitter Saturation Voltage vs. Ambient Temperature

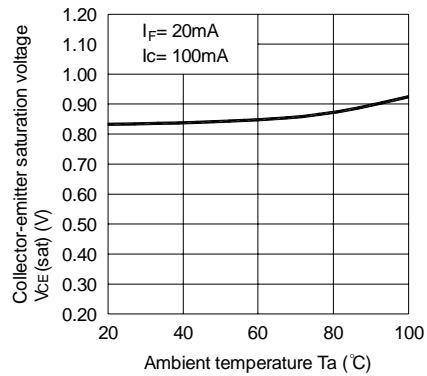

Fig.9 Collector Dark Current vs. Temperature

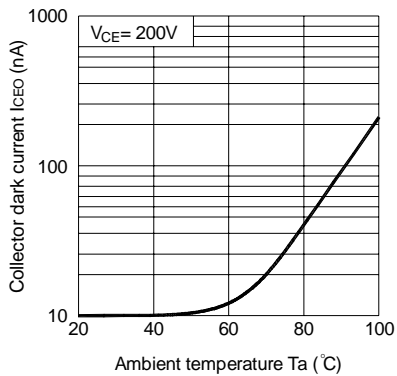

Fig.10 Response Time vs. Load Resistance

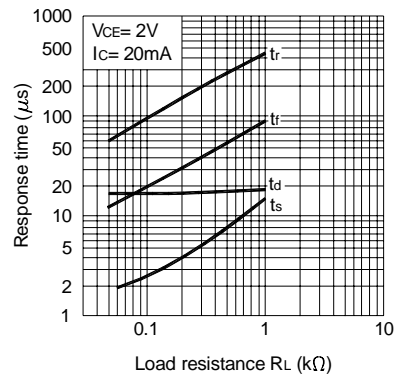
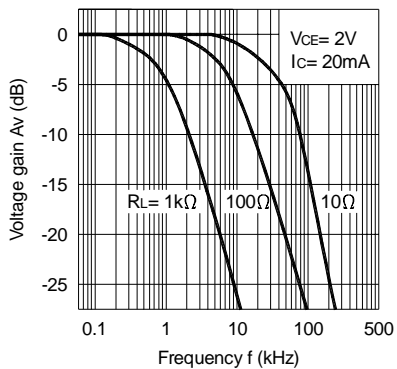
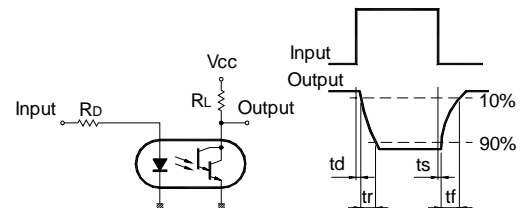

Fig.11 Frequency Response



Test Circuit for Response Time



Test Circuit for Frequency Response

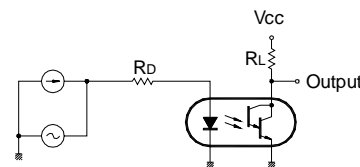

RECOMMENDED FOOT PRINT PATTERNS (MOUNT PAD)

Unit : mm

4 PIN

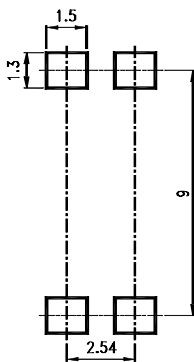

8 PIN

