



LV4124W

Single-chip LCD panel driver IC (Supports the ALP202 LCD panel)

Overview

The LV4124W is a LCD panel driver for use in low-temperature polysilicon TFT LCDs that integrates an RGB decoder, a driver, and a timing controller in a single chip. This IC is manufactured in Bi-CMOS process and supports the ALP202 2.0-inch color LCD panel.

Functions

- Analog block: RGB decoder/driver
- Digital block: Timing generator

Features

- Supports NTSC/PAL standard
- Supports composite, Y/C, and Y/color difference inputs
- Built-in BPF, TRAP, and DL circuits
- Sharpness function
- Dual point γ correction circuit
- Pre-charge circuit
- R and B outputs delay time correction circuit (Supports up and down and right and left inversions)
- Polarity reverse circuit
- External RGB input supported
- Line inversion supported
- Supports AC drive for the LCD panel during no signal
- Serial bus for mode setting and electric VR

Package

- SQFP-64 plastic package

Package Dimensions

unit: mm

SQFP-64

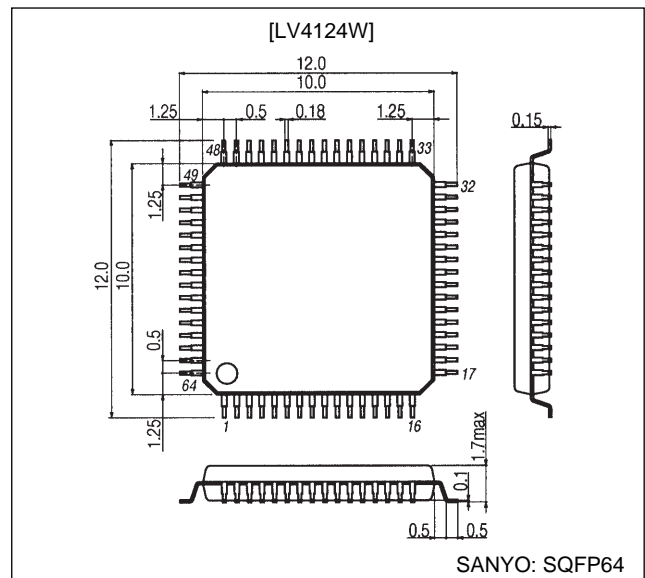

■ Any and all SANYO products described or contained herein do not have specifications that can handle applications that require extremely high levels of reliability, such as life-support systems, aircraft's control systems, or other applications whose failure can be reasonably expected to result in serious physical and/or material damage. Consult with your SANYO representative nearest you before using any SANYO products described or contained herein in such applications.

■ SANYO assumes no responsibility for equipment failures that result from using products at values that exceed, even momentarily, rated values (such as maximum ratings, operating condition ranges, or other parameters) listed in products specifications of any and all SANYO products described or contained herein.

SANYO Electric Co., Ltd. Semiconductor Business Headquarters

TOKYO OFFICE Tokyo Bldg., 1-10, 1 Chome, Ueno, Taito-ku, TOKYO, 110-8534 JAPAN

LV4124W

Specifications

Maximum Ratings at Ta = 25°C

Parameter	Symbol	Conditions	Rating	Units
Maximum supply voltage	V _{CC1} max	Analog 4.5V system	6	V
	V _{CC2} max	Analog 12V system	14	V
	V _{DD} max	Digital system	4.5	V
Allowable power dissipation	Pd max	With Ta ≤ 75°C*	350	mW
Operating temperature	Topr		-15 to +75	°C
Storage temperature	Tstg		-40 to +125	°C
Input pin voltage	V _{INA}	Analog input pins	-0.3 to V _{CC1}	V
	V _{IND}	Digital input pins	-0.3 to V _{DD} +0.3	V

Note *: When mounted on a printed circuit board (30 × 30 mm, t = 1.6 mm, material: glass/epoxy)

Operating Conditions at Ta = 25°C

Parameter	Symbol	Conditions	Rating	Units
Recommended supply voltage	V _{CC1}	Analog 4.5V system	4.5	V
	V _{CC2}	Analog 12V system	12.0	V
	V _{DD}	Digital system	3.0	V
Operating supply voltage range	V _{CC1op}	Analog 4.5V system	4.25 to 5.25	V
	V _{CC2op}	Analog 12V system	11 to 13.5	V
	V _{DDop}	Digital system	2.7 to 3.6	V

Electrical Characteristics at V_{CC1} = 4.5 V, V_{CC2} = V_{CCPCD} = 12.0 V, GND1 = GND2 = GNDPCD = 0 V, V_{DD} = 3.0 V V_{SS1} = V_{SS2} = 0 V, and Ta = 25°C

DC Characteristics

Parameter	Symbol	Conditions	Ratings			Unit	
			min	typ	max		
[Current Characteristics]							
Current drain: V _{CC1} 4.5V system	ICC11	Input SIG4 to (A) and SIG2 (0 dB) to (B). Measure the ICC1 current.	Composite input	22	29	35	mA
	ICC12		Y/C input	21	28	34	mA
	ICC13	Input SIG4 to (A), (D), and (E). Measure the ICC1 current.	Y/color difference input	18	23	28	mA
Current drain: V _{CC2} 12V system	ICC2	Input SIG4 to (A) and SIG2 (0 dB) to (B). Measure the ICC2 current.		4.5	6.5	8.5	mA
Current drain: V _{DD} MOS circuit blocks	IDD	Input SIG4 to (A) and SIG2 (0 dB) to (B). Measure the IDD current.		4.5	6.0	7.5	mA
[Digital Block Input and Output Characteristics]							
Input current	I _{I1}	Input pins with built-in pull-up resistors *1 V _N = V _{SS}		-24	-60	-145	μA
	I _{I2}	Input pins with built-in pull-down resistors *2 V _N = V _{DD}		24	60	145	μA
High-level output voltage	V _{OH1}	I _{oh} = -1 mA *3	V _{DD} - 0.2				V
Low-level output voltage	V _{OL1}	I _{ol} = 1 mA *3				0.3	V
CKO pin high-level output voltage	V _{OH2}	I _{oh} = -3 mA	0.5V _{DD}				V
CKO pin low-level output voltage	V _{OL2}	I _{ol} = 3 mA				0.5V _{DD}	V
RPD pin high-level output voltage	V _{OH3}	I _{oh} = -0.5 mA	V _{DD} - 1.2				V
RPD pin low-level output voltage	V _{OL3}	I _{oh} = 0.7 mA				1.0	V
RPD pin output off leakage current	I _{OFF}	In the high-impedance state, V _{OUT} = V _{SS} or V _{DD} .		-40		40	μA
Input voltage threshold (high)	V _{TDH}	Input pins *1, *2		0.7V _{DD}			V
Input voltage threshold (low)	V _{TDL}	Input pins *1, *2				0.3V _{DD}	V

Notes: 1. Input pins with built-in pull-up resistors: VDIN, CSH, CSV, SCLK, DATA, and LOAD

2. Input pins with built-in pull-down resistors: PANEL and TEST

3. Output pins other than CKO and RPD: XSTH, STH, CKH2, CKH1, PCG2, PCG1, HD, XSTV, STV, CKV2, CKV1, XENB, ENB, and VD.

LV4124W

AC Characteristics (1) when the T41, T44, and T46 outputs are measured at the noninverted outputs.

Parameter	Symbol	Conditions	Ratings			Unit
			min	typ	max	
[Luminance Signal System]						
Contrast characteristics (typ.)	GCNTP	Input SIG4 to (A) and measure the ratio of the T44 output amplitude (white - black) to the input amplitude.	13	17	21	dB
Contrast characteristics (min.)	GCNTMN	Input SIG4 to (A) and measure the ratio of the T44 output amplitude (white - black) to the input amplitude.	-9	-5	-1	dB
Maximum video gain	GV	Input SIG4 to (A) and measure the ratio of the T44 output amplitude (white - black) to the input amplitude.	19	22	25	dB
[Luminance Signal Frequency Characteristics]						
Y/C input	FCYYC	Take the T44 output amplitude with SIG7 (0 dB, no burst, 100 kHz) input to (A) as 0 dB. Modify the input frequency and determine the frequency such that the output is down -3 dB.		5.0		MHz
Composite input	NTSC FCYCMN		2.5			
	PAL FCYCMP		2.5			
Image quality adjustment range 1 (Y/C input)	GSHP1X	Take the T44 output amplitude with SIG7 (100 kHz) input to (A) as 0 dB. Determine the ratio of the output amplitude with a 2.5-MHz SIG7 input.	MAX	12	16	dB
	GSHP1N		MIN		0	
Image quality adjustment range 3 (composite input)	GSHP3X	Take the T44 output amplitude with SIG7 (100 kHz) input to (A) as 0 dB. Determine the ratio of the output amplitude with a 2.0-MHz SIG7 input.	MAX	6	10	dB
	GSHP3N		MIN		-2	
Chrominance signal leakage	CRLEKY	Input SIG2 (0 dB) to (A) and using a spectrum analyzer, measure the 3.58 and 4.43 MHz components in the input and in T44. Let ΔCLK be that difference. Use that value to determine CRLEKY from the following formula: $CRLEKY = 150 \text{ mV} \times 10^{\Delta CLK/20}$			30	mV
[Luminance Signal Input to Output Delay]						
Y/C input	TDYYC	Input SIG5 (VL = 150 mV) to (A). Measure the delay time between a rising edge in the input and the corresponding rising edge in the T44 noninverted output.	250	350	450	ns
Composite input	NTSC TDYCMN		500	600	700	ns
	PAL TDYCMP		500	600	700	ns
[Color Difference Signal System]						
Color difference input color adjustment	GEXCMX	Input SIG5 (VL = 150 mV) to (A) and SIG1 (0 dB, 100 kHz, no burst) to (D). Let VC0 be the T41 output amplitude (100 kHz) when COL = 128. Let VC2 be the T41 output amplitude (100 kHz) when COL = 0. Let VC1 be the T41 output amplitude (100 kHz) when SIG1 is set to -10 dB and COL = 255. Then calculate the following formulas. GEXCMX = $20 \log (VC1/VC0) + 10$ GEXCMN = $20 \log (VC2/VC0)$	+4	+6		dB
	GEXCMN			-15	-11	dB
Color difference balance	VEXCBL	Input SIG5 (VL = 150 mV) to (A) and SIG1 (0 dB, 100 kHz, no burst) to (D) and (E). Let VB be the T41 output amplitude (100 kHz), and let VR be the T46 output amplitude (100 kHz). Calculate $VEXCBL = VR/VB$.	0.85	1	1.15	-

Continued on next page.

LV4124W

Continued from preceding page

Parameter	Symbol	Conditions	Ratings			Unit
			min	typ	max	
[Color Difference Signal System]						
Color difference input balance adjustment R	GEXRMX	Input SIG5 (VL = 150 mV) to (A) and SIG1 (-6 dB, 100 kHz, no burst) to (D) and (E). When TINT = 128, let VR0 be the T46 output amplitude (100 kHz) and let VB0 be the T41 output amplitude (100 kHz).	+2	+3		dB
	GEXRMN	When TINT = 255, let VR1 be the T46 output amplitude and let VB1 be the T41 output amplitude.	-3	-4.5		dB
Color difference input balance adjustment B	GEXBMX	When TINT = 0, let VR2 be the T46 output amplitude and let VB2 be the T41 output amplitude.	-3	-4.5		dB
	GEXBMN	Then calculate the following formulas. GEXRMX = 20log (VR1/VR0) GEXRMN = 20log (VR2/VR0) GEXBMX = 20log (VB1/VB0) GEXBMN = 20log (VB2/VB0)	+2	+3		dB
G-Y matrix characteristics (NTSC)	VEXGBN	Input SIG5 (VL = 150 mV) to (A) and SIG1 (0 dB, 100 kHz, no burst) to (D). Let VEXB be the T41 output amplitude (100 kHz) and VEXBG be the T44 output amplitude (100 kHz). Calculate VEXGB = VEXBG/VEXB.	0.21	0.24	0.27	-
	VEXGRN	Input SIG5 (VL = 150 mV) to (A) and SIG1 (0 dB, 100 kHz, no burst) to (E). Let VEXR be the T46 output amplitude (100 kHz) and VEXRG be the T44 output amplitude (100 kHz). Calculate VEXGR = VEXRG/VEXR.	0.46	0.51	0.56	-
G-Y matrix characteristics (PAL)	VEXGRP	Input SIG5 (VL = 150 mV) to (A) and SIG1 (0 dB, 100 kHz, no burst) to (D). Let VEXB be the T41 output amplitude (100 kHz) and VEXBG be the T44 output amplitude (100 kHz). Calculate VEXGB = VEXBG/VEXB.	0.17	0.19	0.21	-
	VEXGRP	Input SIG5 (VL = 150 mV) to (A) and SIG1 (0 dB, 100 kHz, no burst) to (E). Let VEXR be the T46 output amplitude (100 kHz) and VEXRG be the T44 output amplitude (100 kHz). Calculate VEXGR = VEXRG/VEXR.	0.46	0.51	0.56	-

AC Characteristics (2)

Parameter	Symbol	Conditions	Ratings			Unit	
			min	typ	max		
[Chrominance Signal System]							
ACC amplitude characteristics 1	ACC1	Input SIG5 (VL = 150 mV) to (A), and to (B), input SIG2 (0, +6, and -20 dB, 3.58 MHz, burst/chrominance phase = 180°, and also 4.43 MHz, burst/chrominance phase = ±135°). Measure the T53 output amplitude, and let V0, V1, and V2 correspond to 0 dB, +6 dB, and -20 dB, respectively. ACC1 = 20log (V1/V0) ACC2 = 20log (V2/V0)	NTSC	-3	0	+3	dB
			PAL	-3	0	+3	
ACC amplitude characteristics 2	ACC2		VTSC	-3	0	+3	
			PAL	-3	0	+3	
APC pull-in range	FAPC	Input SIG5 (VL = 150 mV) to (A), and to (B), input SIG2 (0 dB, 3.58 MHz, burst/chrominance phase = 180°, and also 4.43 MHz, burst/chrominance phase = ±135°). Measure the T44 output amplitude. Modify the SIG2 burst frequency, until the killer is released. Measure the frequency f1 that appears in the T41 output. NTSC f1 = 3579545 Hz PAL f1 = 4433619 Hz	NTSC	±500			Hz
			PAL	±500			

Continued on next page.

LV4124W

Continued from preceding page

Parameter	Symbol	Conditions	Ratings			Unit	
			min	typ	max		
[Chrominance Signal System]							
Color adjustment characteristics (maximum)	GCOLMX	Input SIG5 (VL = 150 mV) to (A), and input SIG2 (0 dB, burst/chrominance phase = 180°) to (B). Let V0, V1, and V2 be the chrominance signal amplitude when COL = 128, COL = 255, and COL = 0, respectively. Calculate GCOLMX = 20log (V1/V0), and GCOLMN = 20log (V2/V0).	+4	+6		dB	
Color adjustment characteristics (minimum)	GCOLMN		-20	-15		dB	
Tint adjustment range (maximum)	TNTMX	Input SIG5 (VL = 150 mV) to (A), and input SIG2 (0 dB, with a variable burst/chrominance phase) to (B). Let θ_0 , θ_1 , and θ_2 be the phases when the T41 output amplitude is minimum when TINT = 128, TINT = 255, and TINT = 0, respectively. Calculate TNTMX = $\theta_1 - \theta_0$, and TNTMN = $\theta_2 - \theta_0$.	-30	-40		deg	
Tint adjustment range (minimum)	TNTMN		30	40		deg	
Killer operating input level	ACKN	Input SIG5 (VL = 150 mV) to (A), and to (B), input SIG2 (with a variable level, burst/chrominance phase = 180°, and also burst/chrominance phase = $\pm 135^\circ$). Measure the T41 output amplitude. Gradually lower the SIG3 level (amplitude) until the killer function operates and measure that level.	NTSC		-36	30	dB
	ACKP		PAL		-33	-27	dB
Demodulator output amplitude ra io (NTSC)	VRBN	Input SIG5 (VL = 150 mV) to (A), and input SIG3 (0 dB) to (B). Modify the chrominance signal phase, let VB be the maximum amplitude of the T41 chrominance demodulated signal, let VG be the maximum amplitude of the T44 chrominance demodulated signal, and let VR be the maximum amplitude of the T46 chrominance demodulated signal. Calculate VRBN = VR/VB and VGBN = VG/VB.	0.53	0.63	0.73	-	
	VGBN		0.25	0.32	0.39	-	
Demodulator output phase difference (NTSC)	θ RBN	Input SIG5 (VL = 150 mV) to (A), and input SIG3 (0 dB) to (B). Modify the chrominance signal phase, let θ_B be the phase at the maximum amplitude of the T41 chrominance demodulated signal, let θ_G be the phase at the maximum amplitude of the T44 chrominance demodulated signal, and let θ_R be the phase at the maximum amplitude of the T46 chrominance demodulated signal. Calculate θ RBN = $\theta_R - \theta_B$ and θ GBN = $\theta_G - \theta_B$.	99	109	119	deg	
	θ GBN		230	242	254	deg	
Demodulator output amplitude ra io (PAL)	VRBP	Input SIG5 (VL = 150 mV) to (A), and input SIG3 (0 dB) to (B). Modify the chrominance signal phase, let VB be the maximum amplitude of the T41 chrominance demodulated signal, let VG be the maximum amplitude of the T44 chrominance demodulated signal, and let VR be the maximum amplitude of the T46 chrominance demodulated signal. Calculate VRBP = VR/VB and VGBP = VG/VB.	0.65	0.75	0.85	-	
	VGBP		0.33	0.40	0.47	-	
Demodulator output phase difference (PAL)	θ RBP	Input SIG5 (VL = 150 mV) to (A), and input SIG3 (0 dB) to (B). Modify the chrominance signal phase, let θ_B be the phase at the maximum amplitude of the T41 chrominance demodulated signal, let θ_G be the phase at the maximum amplitude of the T44 chrominance demodulated signal, and let θ_R be the phase at the maximum amplitude of the T46 chrominance demodulated signal. Calculate θ RBP = $\theta_R - \theta_B$ and θ GBP = $\theta_G - \theta_B$.	80	90	100	deg	
	θ GBP		232	244	256	deg	

LV4124W

AC Characteristics (3)

Parameter	Symbol	Conditions	Ratings			Unit
			min	typ	max	
[RGB Signal and PCD Output Systems]						
RGB signal and PCD output DC voltage	VOUT	Input SIG5 (VL = 0 mV) to (A), adjust the BRIGHT parameter with the serial bus data so that T44 is 9 Vp-p, and measure the DC voltages on T39, T41, T44, and T46.	5.85	6.00	6.15	V
RGB signal and PCD output DC voltage difference	ΔVOUT	Determine the maximum value of the differences in the measured values of VOUT in the previous item for T39, T41, T44, and T46.		0	100	mV
RGB signal and PCD output Color difference input balance	VLIMMX	Input SIG3 to (A), and measure the maximum value (VLIMMX) and minimum value (VLIMMN) of the voltage range (black - black) over which the black limiter operates when V54 is varied for T39, T41, T44, and T46. Measure VLIMMX when V54 = 0 V, and measure VLIMMN when V54 = 4.5 V.	9.0			Vpp
	VLIMMN				5.2	Vpp
Brightness variation	BRTMX	Input SIG5 (VL = 0 mV) to (A) and set BRT to 0. Measure the T41, T44, and T46 outputs (black - black).	9.0			Vpp
	BRTMN	Input SIG5 (VL = 0 mV) to (A) and set BRT to 255. Measure the T41, T44, and T46 outputs (black - black).			4.0	Vpp
PCD variation	PCDMX	Input SIG5 (VL = 0 mV) to (A) and measure the T39 output (black - black) when P-BRT is set to 255.	9.0			Vpp
	PCDMN	Input SIG5 (VL = 0 mV) to (A) and measure the T39 output (black - black) when P-BRT is set to 0.			3	Vpp
Sub-brightness variation	SBBRT	Input SIG5 (VL = 0 mV) to (A) and measure the T44 output (black - black) with respect to the T41 and T46 outputs (black - black) when R-BRT = B-BRT = 0, and when R-BRT = B-BRT = 255.	±2.0	±3.0		V
RGB inter-signal gain difference	ΔGRGB	Input SIG4 to (A) and determine the level difference between the largest and the smallest of the noninverted output amplitudes (white - black) for T41, T44, and T46.	-0.5	0	0.5	dB
RGB inverted/noninverted gain difference	ΔGINV	Input SIG4 to (A) and determine the difference between the inverted output amplitude and the noninverted output amplitude (white - black) for T41, T44, and T46.	-0.5	0	0.5	dB
RGB inter-signal black level potential difference	ΔVBL	Input SIG4 to (A) and determine the difference between the highest and lowest black levels in the inverted and noninverted T41, T44, and T46 outputs.			300	mV
Gamma gain	G _{γ1}	Input SIG8 to (A), adjust the T44 inverted output black level to be 1.5 V with BRT, and adjust the amplitude (black - white) to be 3.5 V with CONT. Measure VG1, VG2, and VG3 and calculate the following formulas. G _{γ1} = 20log (VG1/0.0357) G _{γ2} = 20log (VG2/0.0357) G _{γ3} = 20log (VG3/0.0357)	23.0	26.0	29.0	dB
	G _{γ2}		12.0	15.0	18.0	dB
	G _{γ3}		18.0	21.0	25.0	dB
Gamma 1 adjustment range	V _{γ1MN}	Input SIG8 to (A) and set the T44 output (black - black) to 9 V p-p with the BRIGHT adjustment. Read the gamma gain transition point at the input signal IRE level when γ1 = 0 and when γ1 = 255. V _{γ1MN} is when γ1 = 0, and V _{γ1MX} is when γ1 = 255.			0	IRE
	V _{γ1MX}		70			IRE
Gamma 2 adjustment range	V _{γ2MN}	Input SIG8 to (A) and set the T44 output (black - black) to 9 V p-p with the BRIGHT adjustment. Read the gamma gain transition point at the input signal IRE level when γ2 = 0 and when γ2 = 255. V _{γ2MN} is when γ2 = 0, and V _{γ2MX} is when γ2 = 255.	100			IRE
	V _{γ2MX}				30	IRE
PCD transition time	tPCDH	The transition time for a load of 8000 pF and an amplitude of 9 V p-p. tPCDH: For rising edges. tPCDL: For falling edges.			2.5	μs
	tPCDL				2.5	μs

LV4124W

AC Characteristics (4)

Parameter	Symbol	Conditions	Ratings			Unit
			min	typ	max	
[Filter Characteristics]						
Bandpass filter attenuation	ATBPF	Input SIG5 (VL = 0 mV) to (A) and SIG1 (0 dB) to (B). Take the T53 chrominance amplitude when the center frequency (3.58 and 4.43 MHz) is input to be 0 dB, and measure the T53 output attenuation for the frequencies listed at the right.	NTSC 1.50 MHz	-15	-10	dB
			PAL 2.00 MHz	-15	-10	dB
			NTSC 5.50 MHz	-7	-2	dB
			PAL 6.80 MHz	-8	-3	dB
Trap attenuation	ATRAPH	Input SIG7 (0 dB, 3.58 and 4.43 MHz) to (A) and measure the T44 output with a spectrum analyzer. Taking the T44 amplitude in Y/C mode to be 0 dB, determine the attenuation in composite input mode.	NTSC	-40	-30	dB
	ATRAPP		PAL	-40	-30	dB
R-Y and B-Y low-pass filter	DEMLPF	Input SIG5 (VL = 150 mV) to (A) and SIG2 (0 dB, 3.58 MHz + 100 kHz) to (B). Take the T44 output 100 kHz component amplitude at this time to be 0 dB, and determine the frequency at which the output beat component is reduced by 3 dB when the SIG2 frequency is increased from 3.58 MHz.	0.7	0.9	1.1	MHz
[Sync Separator Circuit and TG System]						
Input synchronizing signal amplitude sensitivity	WSSEP	Input SIG5 (VL = 0 mV, VS = 143 mV, variable WS) to (A) and verify synchronization with the T23 HD output. Determine the value of WS at the point synchronization with the T23 HD output is lost when the SIG5 WS is gradually made narrower starting at 4.7 μs.	2.0			μs
Sync separator circuit input sensitivity	VSSEP	Input SIG5 (VL = 0 mV, WS = 4.7 μs, variable VS) to (A) and verify synchronization with the T23 HD output. Determine the value of VS at the point synchronization with the T23 HD output is lost when the SIG5 VS is gradually reduced starting at 143 mV.		40	60	mV
Sync separator circuit output delay	TDSYL	Input SIG5 (VL = 0 mV, WS = 4.7 μs, VS = 143 mV) to (A) and measure the delay time with respect to the T12 RPD output. Here, TDSYL is the delay from the fall of the input HSYNC signal to the fall of the T12 RPD output, and TDSYH is the delay from the rise of the input HSYNC signal to the rise of the T12 RPD output.	430	630	830	ns
	TDSYH		4.7	5.0	5.3	μs
Horizontal pull-in range	HPLLN	Input SIG5 (VL = 0 mV, WS = 4.7 μs, VS = 143 mV, variable horizontal frequency) to (A) and verify synchronization with the T23 HD output. Determine the frequency fH at which synchronization is achieved when the SIG5 horizontal frequency is varied starting from the state where I/O synchronization is lost. Calculate HPLLN = fH - 15734 and HPLLP = fH - 15625.	NTSC	±500		Hz
	HPLLP		PAL	±500		Hz

Continued on next page.

LV4124W

Continued from preceding page

Parameter	Symbol	Conditions	Ratings			Unit
			min	typ	max	
[External I/O Characteristics]						
External RGB input threshold voltage	VTEXTB	Input SIG5 (VL = 0 mV) to (A) and SIG6 (variable VL) to (C). Let VTEXTB be the voltage at which the T41, T44, and T46 outputs reach the black level when the amplitude (VL) is raised starting at 0 V. Then, let VTEXTW be the voltage at which the outputs reach the white level as the amplitude is increased further.	0.8	1	1.2	V
	VTEXTW		1.8	2.0	2.2	V
External RGB input to output transmission delay time	TDEXTB	Input SIG5 (VL = 0 mV) to (A) and SIG6 (VL = 3 V) to (C). Measure TDEXTB, the delay in the T41, T44, and T46 output rise, and TDEXTL, the delay in the output fall time.	70	100	120	ns
	TDEXTL		70	100	120	ns
External RGB input to output blanking level difference	EXTBK	Input SIG5 (VL = 0 mV) to (A) and SIG6 (VL = 1.7 V) to (C) and measure the difference from the T41, T44, and T46 black levels.			0	V
External RGB input to output white level difference	EXTWT	Input SIG5 (VL = 0 mV) to (A) and SIG6 (VL = 2.7 V) to (C) and measure the difference from the T41, T44, and T46 black levels.	3.5			V
[Digital Block Output Characteristics]						
Output transition time (For the pins *3.)	tTLH	Input SIG5 (VL = 0 mV) to (A). Use a load of 30 pF.			30	ns
	tTHL				30	ns
Cross point time difference	ΔT	Input SIG5 (VL = 0 mV) to (A). Use a load of 30 pF. CKH1/CKH2			10	ns
CKH duty	DTYHC	Input SIG5 (VL = 0 mV) to (A). Use a load of 30 pF. Measure the CKH1 and CKH2 duty.	47	50	53	%

LV4124W

Block Diagram

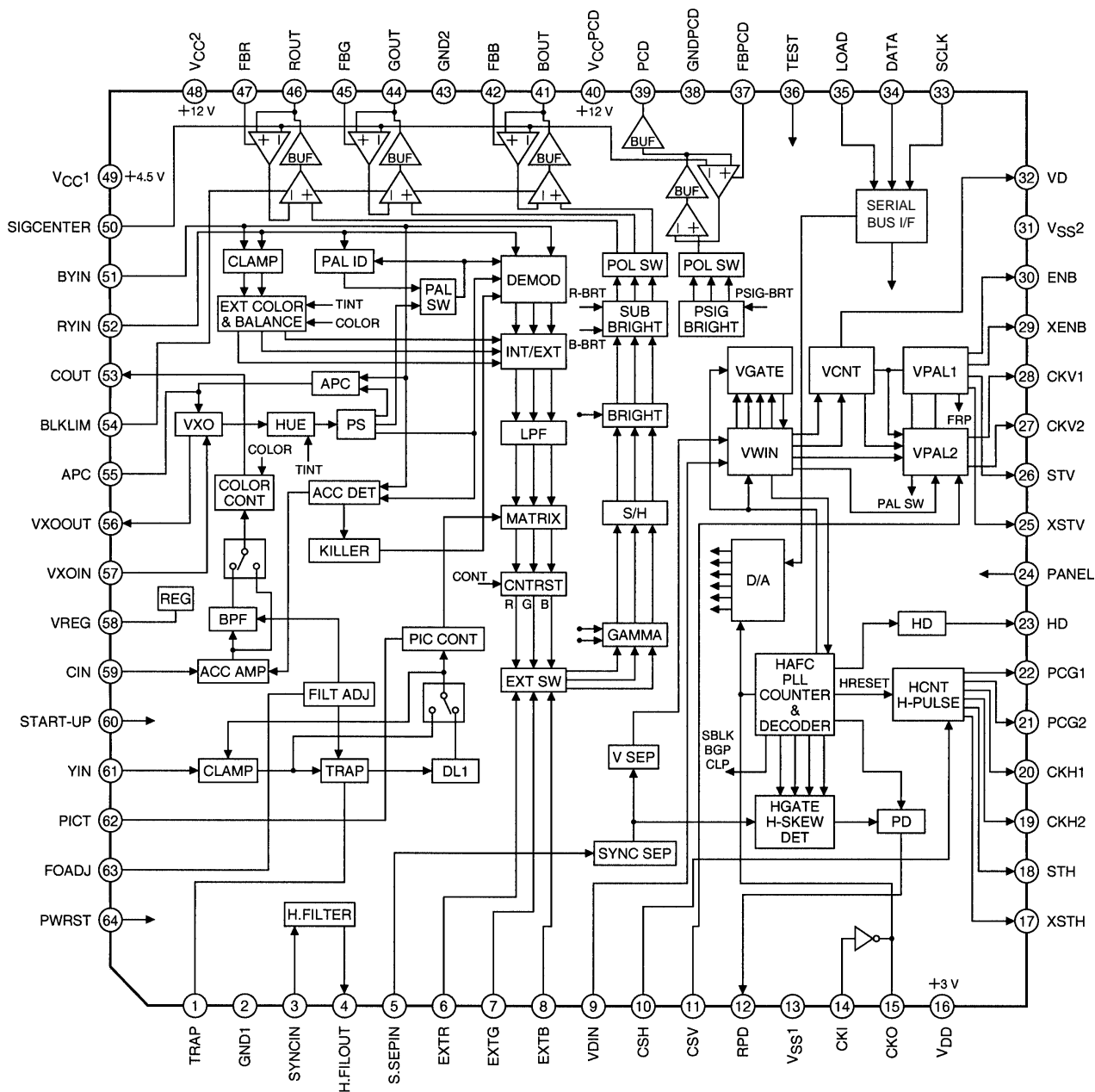

A11372

LV4124W

Analog Block Pin Functions

Units (Capacitors: F, Resistors: Ω)

Pin No.	Pin	Pin voltage	I/O	Input handling	Pin function	Equivalent circuit
1	TRAP	-			<p>External trap circuit connection.</p> <p>Chrominance components are excluded by a series LC circuit (inductor and capacitor) connected to ground.</p> <p>(This pin is left open in Y/color difference input mode.)</p>	<p style="text-align: right;">A11373</p>
2	GND1	0 V			Analog 4.5V system ground	
3	SYNCIN	1.5 V	I		<p>Sync separator circuit low-pass filter input.</p> <p>The standard input signal level is 0.5 V_{p-p} (sync tip to 100% white level). The input should be provided with low impedance (under 75 Ω).</p>	<p style="text-align: right;">A11374</p>
4	H.FILOUT	2.3 V	O		Sync separator circuit low-pass filter output	<p style="text-align: right;">A11375</p>
5	S.SEPIN	1.0 V	I		<p>Sync separator circuit input.</p> <p>Input the waveform that results from passing the input signal through the sync separator circuit low-pass filter to this pin.</p>	<p style="text-align: right;">A11376</p>

Continued on next page.

LV4124W

Continued from preceding page.

Units (Capacitors: F, Resistors: Ω)

Pin No.	Pin	Pin voltage	I/O	Input handling	Pin function	Equivalent circuit
6	EXTR	-	I		<p>These pins are used to input external digital signals.</p> <p>There are two threshold levels: V_{th1} (about 1.0 V) and V_{th2} (about 2.0 V). If one of the RGB signal exceeds V_{th1}, then all of the RGB outputs are set to the black level, and the output only goes to the white level when the input exceeds V_{th2}.</p>	
7	EXTG					
8	EXTB					
37	FBPCD	2.5 V	O		<p>Feedback circuit smoothing capacitor connections. These circuits are used to control the DC levels in the RGB and PCD outputs.</p> <p>Since these are high-impedance circuits, capacitors with low leakage must be used.</p>	
42	FBB					
45	FBG					
47	FBR					
38	GNDPCD	0 V			Ground for the PCD circuit	
39	PCD	6.0 V	O		PCD output	
40	V_{CCPCD}	12 V			<p>12V system power supply used for the PCD circuit.</p> <p>Use the same potential as used for V_{CC2}.</p>	

Continued on next page.

LV4124W

Continued from preceding page.

Units (Capacitors: F, Resistors: Ω)

Pin No.	Pin	Pin voltage	I/O	Input handling	Pin function	Equivalent circuit
41	BOUT	6.0 V	O		RGB signal outputs	
44	GOUT					
46	ROUT					
43	GND2	0 V			Analog 12V system ground	
48	V _{CC2}	12 V			Analog 12V system power supply	
49	V _{CC1}	4.5 V			Analog 4.5V power supply	
50	SIG CENTER	6.0 V	I		RGB output DC level setting	

Continued on next page.

LV4124W

Continued from preceding page.

Units (Capacitors: F, Resistors: Ω)

Pin No.	Pin	Pin voltage	I/O	Input handling	Pin function	Equivalent circuit
51	BYIN	-	I		<p>These pins are used for the color difference signal inputs in Y/color difference input mode. The clamp level in this mode is 2.8 V.</p> <p>In other modes, the signal from pin 53 is input to these pins. In those modes the pin voltage will be about 1.6 V. The standard input signal level is 0.3 V p-p for a 75% color bar signal.</p>	
52	RYIN					
53	COUT	1.6 V	O		<p>Provides the ACC output.</p> <p>(This pin is left open in Y/color difference input mode.)</p>	
54	BLKLIM	-	I		<p>Sets the RGB output amplitude (black to black) clipping level</p>	
55	APC	2.7 V	O		<p>APC filter connection.</p> <p>(This pin is left open in Y/color difference input mode.)</p>	
56	VXOOUT	2.9 V	O		<p>VXO output</p> <p>(This pin is left open in Y/color difference input mode.)</p>	

Continued on next page.

LV4124W

Continued from preceding page.

Units (Capacitors: F, Resistors: Ω)

Pin No.	Pin	Pin voltage	I/O	Input handling	Pin function	Equivalent circuit
57	VXOIN	3.2 V	I		VXO input (This pin is left open in Y/color difference input mode.)	
58	VREG	3.6 V	O		Regulator output Connect a 1- μ F or larger external capacitor to this pin.	
59	CIN	-	I		Inputs the video signal if a composite input is used. Inputs the chrominance signal if separate Y and C signals are used. (This pin is left open in Y/color difference input mode.)	
60	START-UP	-	I		Connection for the capacitor that determines the time that the RGB outputs are held at the black level when power is first applied. Connect this pin to VCC1 through a resistor of about 22 K Ω if this function is not used. (Threshold level: 2.3 V)	
61	Y-IN	3.1 V	I		Luminance (Y) signal input. The standard input signal level is 0.5 Vp-p (from the sync tip to the 100% white level.) The input should be provided with low impedance (under 75 Ω).	

Continued on next page.

LV4124W

Continued from preceding page.

Units (Capacitors: F, Resistors: Ω)

Pin No.	Pin	Pin voltage	I/O	Input handling	Pin function	Equivalent circuit
62	PICT	-	I		Used to adjustment the luminance signal frequency characteristics. Outlines are emphasized as the voltage is increased.	
63	FOADJ	3.0 V	O		Filter adjustment resistor connection. The reference current is created by a 15-k Ω resistor connected to ground.	
64	PWRST	-	I		Reset pin for the IC internal CMOS circuits. A capacitor should normally be connected between this pin and ground. (Threshold level: 2.2 V)	

LV4124W

Digital Block Pin Functions

Units (Capacitors: F, Resistors: Ω)

Pin No.	Pin	Pin voltage	I/O	Input handling	Pin function	Equivalent circuit
9 10 11 33 34 35	VDIN CSH CSV SCLK DATA LOAD	V_{DD}	I	H	These input pins include internal pull-up resistors	<p style="text-align: right;">A11395</p>
24 36	PANEL TEST	V_{SS2}	I	L	These input pins include internal pull-down resistors	<p style="text-align: right;">A11396</p>
12	RPD	-	O		Phase comparator output (tristate)	<p style="text-align: right;">A11397</p>
13	V_{SS1}	-			VCO circuit digital system ground	
14 15	CKI CKO	-	I/O		Oscillator cell input and output	<p style="text-align: right;">A11398</p>

(L: Pulled down, H: Pulled up)

Continued on next page.

LV4124W

Continued from preceding page.

Units (Capacitors: F, Resistors: Ω)

Pin No.	Pin	Pin voltage	I/O	Input handling	Pin function	Equivalent circuit
16	V _{DD}	-			Digital system power supply	
17 18 19 20 21 22 23 25 26 27 28 29 30 32	XSTH STH CKH2 CKH1 PCG2 PCG1 HD XSTV STV CKV2 CKV1 XENB ENB VD	-	O		Digital block outputs	
31	V _{SS2}	0 V			Digital system ground	

LV4124W

Measurement Waveforms

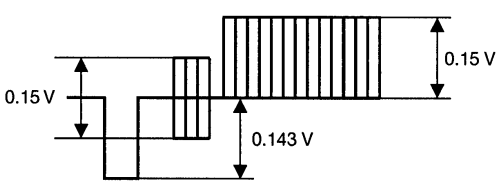
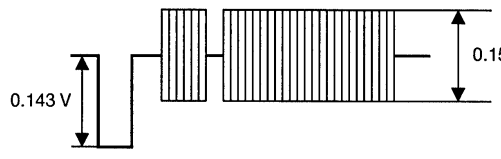
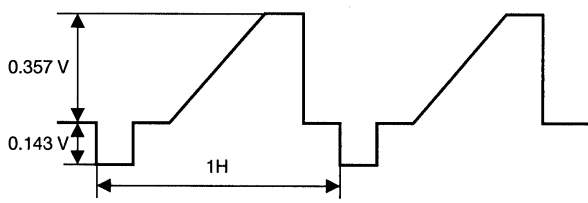
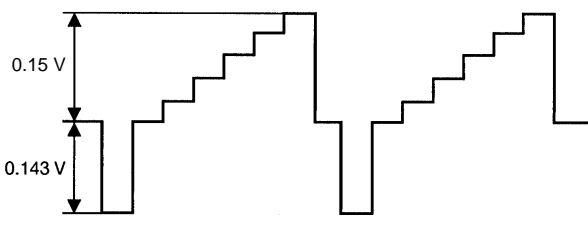
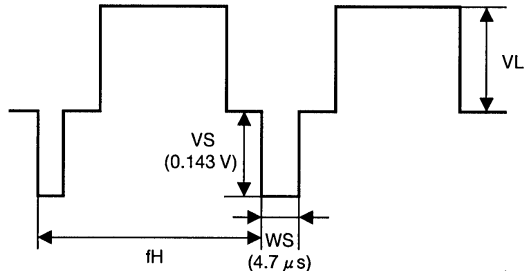
SG No.	Waveform
SIG1	 <p style="text-align: right;">Sine wave video signal; with or without burst. (Variable amplitude, variable frequency)</p> <p style="text-align: right;">← The value at the left is 0 dB.</p> <p style="text-align: right;">A11416</p>
SIG2	<p>Chrominance signal: burst and chrominance frequency (3.579545 or 4.433619 MHz) Variable chrominance phase, variable burst frequency</p>  <p style="text-align: right;">← The value at the left is 0 dB.</p> <p style="text-align: right;">A11417</p>
SIG3	 <p style="text-align: right;">A11418</p>
SIG4	<p>Five-step staircase wave</p>  <p style="text-align: right;">A11419</p>
SIG5	 <p style="text-align: right;">The VL amplitude is variable. Variable VS: 143 mV unless otherwise specified. Variable WS: 4.7 μs unless otherwise specified. Variable fH: NTSC: 15.734 kHz or PAL: 15.625 kHz unless otherwise specified.</p> <p style="text-align: right;">A11420</p>

Continued on next page.

LV4124W

Continued from preceding page

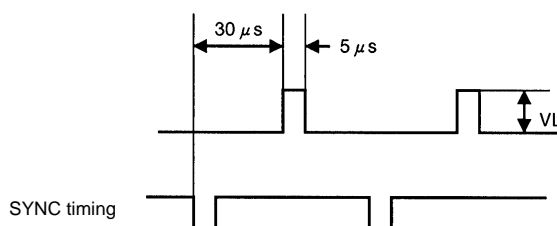
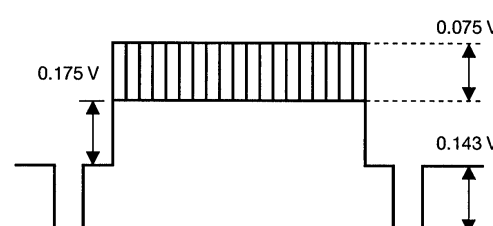
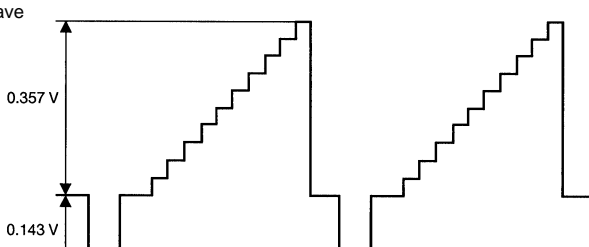
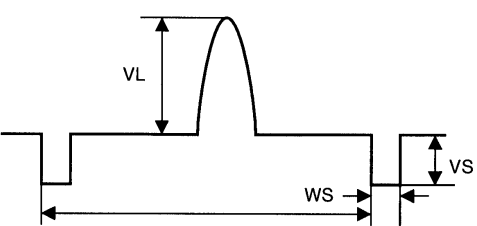
SG No.	Waveform
SIG6	<div style="display: flex; align-items: center;">  <div style="margin-left: 20px;"> <p>The VL amplitude is variable.</p> <p style="text-align: right;">A11421</p> </div> </div>
SIG7	<div style="display: flex; align-items: center;">  <div style="margin-left: 20px;"> <p>Variable frequency</p> <p style="text-align: right;">A11422</p> </div> </div>
SIG8	<div style="display: flex; align-items: center;"> <div style="margin-right: 20px;"> <p>Ten-step staircase wave</p> </div>  <div style="margin-left: 20px;"> <p style="text-align: right;">A11423</p> </div> </div>
SIG9	<div style="display: flex; align-items: flex-start;">  <div style="margin-left: 20px;"> <p>The VL amplitude is variable.</p> <p>Variable VS: 143 mV unless otherwise specified.</p> <p>Variable WS: 4.7 μs unless otherwise specified.</p> <p>Variable fH: NTSC: 15.734 kHz or PAL: 15.625 kHz unless otherwise specified.</p> <p style="text-align: right;">A11424</p> </div> </div>

- Specifications of any and all SANYO products described or contained herein stipulate the performance, characteristics, and functions of the described products in the independent state, and are not guarantees of the performance, characteristics, and functions of the described products as mounted in the customer's products or equipment. To verify symptoms and states that cannot be evaluated in an independent device, the customer should always evaluate and test devices mounted in the customer's products or equipment.
- SANYO Electric Co., Ltd. strives to supply high-quality high-reliability products. However, any and all semiconductor products fail with some probability. It is possible that these probabilistic failures could give rise to accidents or events that could endanger human lives, that could give rise to smoke or fire, or that could cause damage to other property. When designing equipment, adopt safety measures so that these kinds of accidents or events cannot occur. Such measures include but are not limited to protective circuits and error prevention circuits for safe design, redundant design, and structural design.
- In the event that any and all SANYO products described or contained herein fall under strategic products (including services) controlled under the Foreign Exchange and Foreign Trade Control Law of Japan, such products must not be exported without obtaining export license from the Ministry of International Trade and Industry in accordance with the above law.
- No part of this publication may be reproduced or transmitted in any form or by any means, electronic or mechanical, including photocopying and recording, or any information storage or retrieval system, or otherwise, without the prior written permission of SANYO Electric Co., Ltd.
- Any and all information described or contained herein are subject to change without notice due to product/technology improvement, etc. When designing equipment, refer to the "Delivery Specification" for the SANYO product that you intend to use.
- Information (including circuit diagrams and circuit parameters) herein is for example only; it is not guaranteed for volume production. SANYO believes information herein is accurate and reliable, but no guarantees are made or implied regarding its use or any infringements of intellectual property rights or other rights of third parties.

This catalog provides information as of August, 1998. Specifications and information herein are subject to change without notice.