

# LX1710/1711 AUDIOMAX EVALUATION KIT USER'S GUIDE



## INTRODUCING LX1710/1711 AUDIOMAX

Thank you for your interest in the latest generation of AudioMAX products. The enclosed LXE1710 evaluation board is a fully functional mono amplifier designed to demonstrate the “new and improved” Switching Class-D Power Amplifier IC from Linfinity Microsemi. The LX1710/1711 is a completely new controller design with superior performance over the LX1720 stereo controller IC. Key improvements include better SNR, lower noise floor, and reduced THD therefore resulting in a much “quieter” and “cleaner” sounding amplifier.

The evaluation board has been configured with easy-to-use terminal block connections for power supply/battery hook up and speaker connections. An RCA jack or separate audio +/- pins allow a quick interface to your audio source. Jumpers are also provided to enable/disable the amplifier (Sleep control) and to turn off the audio input (Mute control). With minimal setup, the user can be listening to the amplifier in a matter of a few minutes.

Both the LX1710 and LX1711 operate from a single supply voltage. The LXE1710 evaluation board can accommodate a supply voltage from 7V to 15V which produces 25W into 4 $\Omega$  and greater than 38W into 2 $\Omega$ . The LX1711 can handle a higher supply voltage (7V to 25V) and provides greater than 50W continuous output power into 4 $\Omega$ . The evaluation amplifier board has been designed for a 4 $\Omega$  load. The output filter can be easily modified to change frequency response for other load optimization.

Thank you again for your interest in the new “quieter”, high efficiency Class-D Audio Amplifier from Linfinity Microsemi. Please let us know what you think and stay tuned for future product releases to our AudioMAX family of products.

Regards,

Linfinity Microsemi  
<http://www.linfinity.com>  
(714) 898-8121

---

**TABLE OF CONTENTS**

<b>LX1710 / 1710 AudioMAX Evaluation Board Features and Circuit Description .....</b>	<b>4</b>
Input Compensation	
Output Stage	
Filter Stage	
<b>Quick Start Guide.....</b>	<b>5</b>
<b>Application Schematic.....</b>	<b>6</b>
<b>Electrical Characteristics.....</b>	<b>7</b>
<b>Performance Graphs.....</b>	<b>8</b>
<b>Application Information</b>	
Filter Design Tradeoffs (1-Stage vs. 2-Stage).....	9
LC Filter Design.....	9
MOSFET Selection.....	10
Inductor Selection.....	12
Capacitor Selection .....	13
Gate Resistor .....	14
Oscillator Configuration.....	14
Multi Channel Requirements and Frequency Synchronization.....	14
PCB Layout .....	15
<b>Board Layout.....</b>	<b>16</b>
<b>Printed Circuit Board .....</b>	<b>17</b>
<b>Bill of Materials.....</b>	<b>18</b>

Part Number	Product	Description
LX1710CDB	AudioMAX High Fidelity Controller IC	$V_{DD} = 7V$ to $15V$ , Switching Class-D Mono Power Amplifier IC, 28-Pin SSOP Package.
LX1711CDB	AudioMAX High Power Controller IC	$V_{DD} = 7V$ to $25V$ , Switching Class-D Mono Power Amplifier IC, 28-Pin SSOP Package.
LXE1710	LX1710 AudioMAX Evaluation Board	Fully Operational Mono Audio Amplifier.

## LX1710/1711 AUDIOMAX EVALUATION BOARD FEATURES AND CIRCUIT DESCRIPTION

- Fully Assembled Mono Evaluation Board with LX1710 Class-D Controller IC
- Improved SNR and Noise Floor Performance
- Output Power of 25W typical (LX1710,  $15V_{DD}$ ,  $4\Omega$ , 1% THD+N)
- Output Power of 54W typical (LX1711,  $25V_{DD}$ ,  $4\Omega$ , 1% THD+N)
- Supports Full Audio Bandwidth
- Optimized to Drive  $4\Omega$  Speaker Load
- Terminal Block Connectors for Supply Voltage and Speaker Connection
- RCA Plug for Audio Input Signal

The AudioMAX Evaluation Amplifier Board allows the user to quickly connect and evaluate the LX1710 Switching Class-D Mono Controller IC. Easy-to-connect terminal blocks and an RCA plug are provided for interfacing to Power, Speaker, and Audio Input connections. The single stage output filter has been configured to drive a  $4\Omega$  load and support full audio bandwidth amplification (See Application section LC filter design for component selection, calculations, and suggested inductor and capacitor values for other loads). The LXE1710 Evaluation Board operates from a single supply voltage.

The Class-D Amplifier Controller IC requires a minimal number of external components to create a complete amplifier solution. See LXE1710 Evaluation Board Schematic and Bill of Materials for circuit specifics. A Class-D Amplifier is a “switching” amplifier that converts a low-level, analog audio input signal into a high power, pulse-width modulated (PWM) output. The switching frequency (500kHz typical but can be adjusted) is much higher than the audio bandwidth (20Hz to 20kHz), and is easily filtered out with a simple LC filter. The support circuitry can be generally grouped into three areas (input circuit, output power stage, and output filter).

### INPUT COMPENSATION

The first group is the compensation network and control setting components. These resistors and

capacitors set up the controller operating frequency, response characteristics, and comparator ramp fundamental to Class-D operation.

### OUTPUT STAGE

The next section is the output stage. The controller IC generates a PWM output by controlling external FETs connected in a full bridge configuration. The full bridge configuration is connected between the single supply voltage (PVDD) and ground (PGND) with the output of the bridge driving the LC filter stage. Because the FETs are either fully “on” or fully “off”, Class-D topology is extremely efficient (up to 85% typical), circuit power dissipation is minimal, and maximum power is delivered to the speaker. The bridge output also drives the RC low pass filter, which provides the feedback for the control loop through the FBK+ and FBK- inputs.

### FILTER STAGE

The single stage, second order LC filter is used to remove the switching frequency. The frequency response and corner frequency can be easily adjusted for optimization of various loads. The LC evaluation board component values have been chosen for a  $4\Omega$  load. See section on LC filter design for component selection.

## QUICK START GUIDE

The LXE1710 Evaluation Board is a fully functional, Class-D Amplifier. Connection to a single supply voltage (VDD from either a battery or power supply), speakers, and your audio source is all that is required to begin evaluating the amplifier and listening to music. The following outlines the necessary connections and control jumpers.

- 1) Verify contents of Evaluation Kit: The easy-to-use amplifier is all contained on a single board. Visually inspect to see if the board or any components were damaged during shipping. All components are located on the top side of the PCB except for the decoupling capacitor, C17. A copy of the LX1710/1711 Datasheet should also be enclosed or a PDF version can be downloaded from the Microsemi.com website (<http://www.microsemi.com/datasheets/MS1580.PDF>).
- 2) Power and Ground Connections: The voltage supply and ground connections are made through terminal block TB1. Connect your "+" (+7V to +15V) power supply or battery to the +V input of TB1. Connect your supply or battery ground to the GND input of TB1. Please ensure the correct positive and ground connections are made before turning on the power supply.
- 3) Speaker Connection: The amplifier is designed to drive a single 4Ω speaker. Connect speaker "+" and "-" to the +OUT and -OUT input of terminal block TB2 respectively. The amplifier

can be used to drive other speaker loads but frequency response may not be optimal. See LC filter design section for recommended inductor and capacitor modifications.

- 4) Audio Input Connection: Connect your audio source to the RCA Jack CN1, Audio In. For other type interfaces, the audio input signal can also be connected to the amplifier board using the J3 (In- and In+) location. Strip Line Plugs can be inserted into J3 for connectivity.
- 5) Jumper Selection Controls: The "on/off" or enable to the module is controlled with the SLEEP/ signal. Jumper J1 connects the SLEEP/ to "on" or "off". SLEEP/ is an active Low control. Jumper J2 connects the MUTE control which enables/disables the audio input to the amplifier. MUTE is an active High signal. See table below.
- 6) Power Source: If a power supply is being used, make sure it is set to the correct voltage level and turn the power supply on.
- 7) Audio Source: Make sure the audio source signal is set to a minimum level. Start or "play" audio source and adjust source volume to desired level.
- 8) Listen to AudioMAX: If the amplifier is not operating properly, verify preceding steps or contact Linfinity for technical assistance (714) 898-8121.

	Jumper toward OFF	Jumper toward ON	Jumper floating
J1 Jumper: SLEEP/	Amplifier enabled (SLEEP/ is OFF)	Amplifier disabled (SLEEP/ is ON)	Amplifier disabled (SLEEP/ is ON)
J2 Jumper: MUTE	Audio Input enabled (MUTE is OFF)	Audio Input disabled (MUTE is ON)	Audio Input enabled (MUTE is OFF)

**Table 1:** Jumper Settings

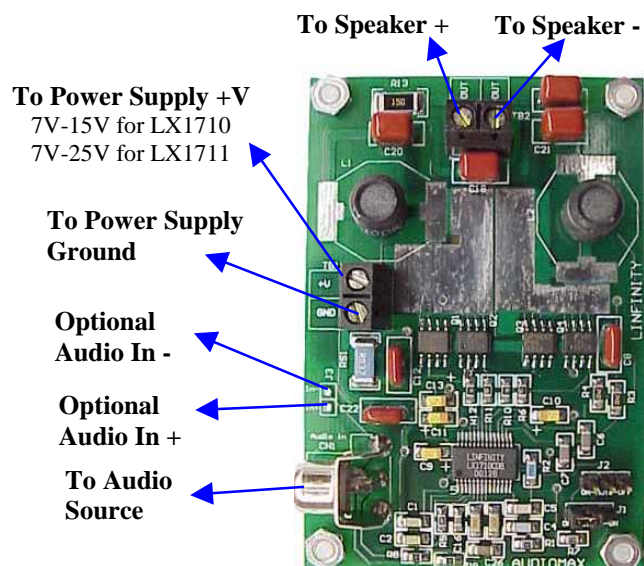

**SCHEMATIC**

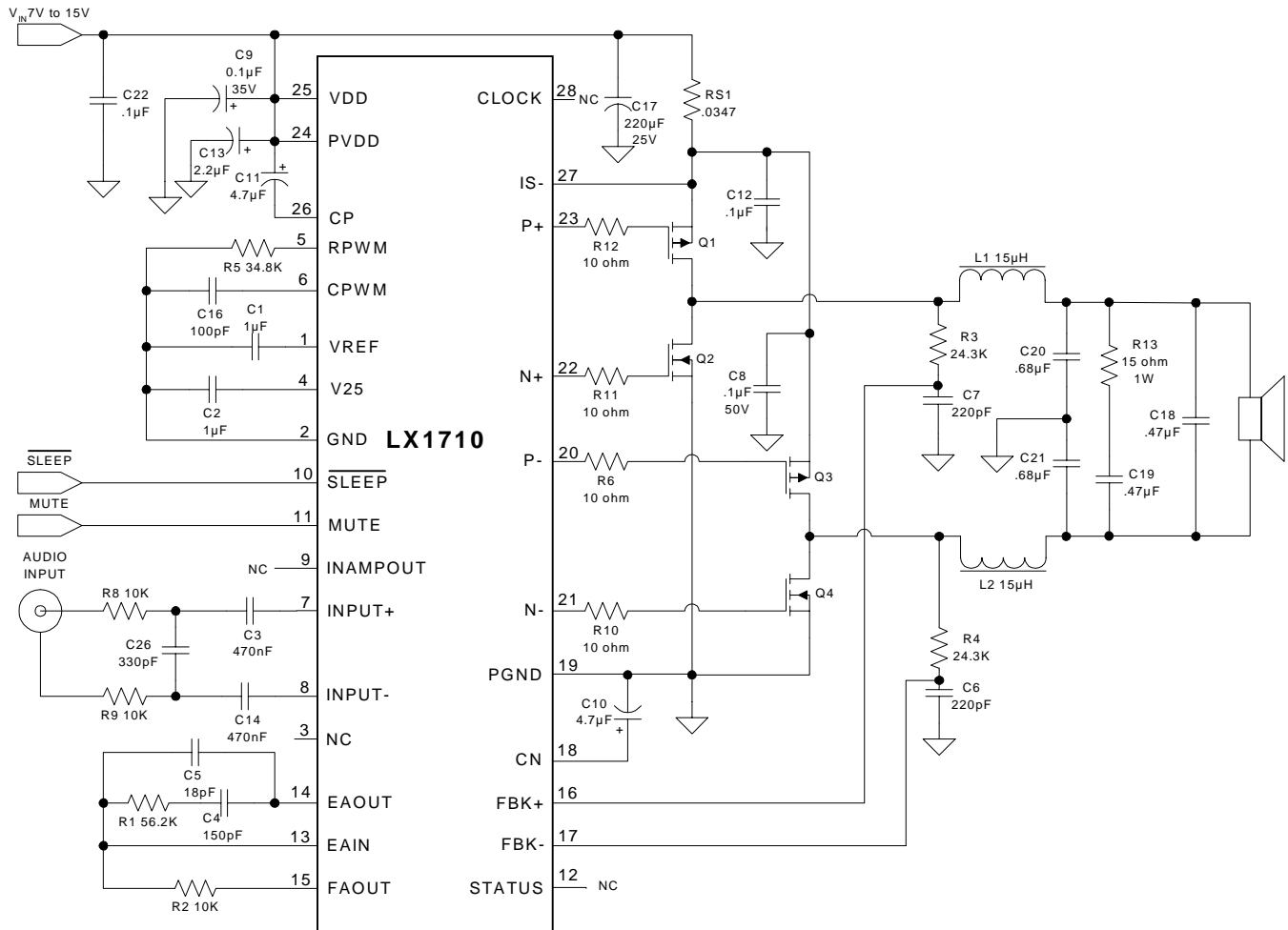

**LXE1710 – Evaluation Board Schematic**

## ELECTRICAL CHARACTERISTICS

Unless otherwise specified, the following specifications apply over the operating ambient temperature  $0^{\circ}\text{C} < \text{TA} < 70^{\circ}\text{C}$ .  
For test circuit, see LXE1710 Evaluation Board Schematic diagram.

PARAMETER	SYMBOL	TEST CONDITIONS	MIN.	TYP.	MAX	UNITS
Supply Voltage LX1710	VDD		7		15	V
Supply Current	IDD	$V_{\text{IN}}=15\text{V}$ , $P_{\text{O}}=38\text{W}$ , $R_{\text{L}}=2\Omega$ , THD+N=1%		3		A
Quiescent Current	IQ	$V_{\text{IN}}=15\text{V}$ , No Input		43		mA
Output Power	PO	$V_{\text{IN}}=15\text{V}$ , $R_{\text{L}}=8\Omega$ , THD+N=1%, 10Hz to 22kHz		14		W
		$V_{\text{IN}}=15\text{V}$ , $R_{\text{L}}=4\Omega$ , THD+N=1%, 10Hz to 22kHz		25		W
		$V_{\text{IN}}=15\text{V}$ , $R_{\text{L}}=2\Omega$ , THD+N=1%, 10Hz to 22kHz		38		W
Efficiency		$V_{\text{IN}}=15\text{V}$ , $f_{\text{IN}}=1\text{kHz}$ , $P_{\text{O}}=10\text{W}$		82		%
		$V_{\text{IN}}=15\text{V}$ , $f_{\text{IN}}=1\text{kHz}$ , $P_{\text{O}}=20\text{W}$		85		%
Total Harmonic Distortion Plus Noise	THD+N	$f_{\text{IN}}=1\text{kHz}$ , $P_{\text{O}}=1\text{W}$		0.05		%
		$f_{\text{IN}}=20\text{Hz}$ to 20kHz, $P_{\text{O}}=1\text{W}$			0.3	%
Signal-To-Noise Ratio	SNR			81		dBV
Power Supply Rejection Ratio	PSRR	$V_{\text{IN}}=15\text{V}$ , $V_{\text{RIPPLE}}=1\text{V}_{\text{RMS}}$ , 10Hz to 10kHz		-70		dB

PERFORMANCE GRAPHS

EFFICIENCY VS. OUTPUT POWER

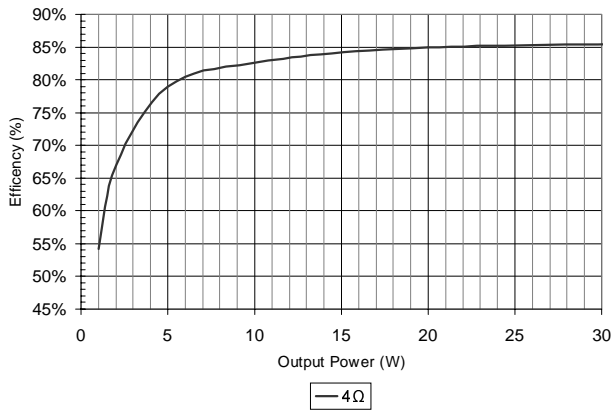

$V_{IN} = 15V$

OUTPUT POWER VS. SUPPLY VOLTAGE

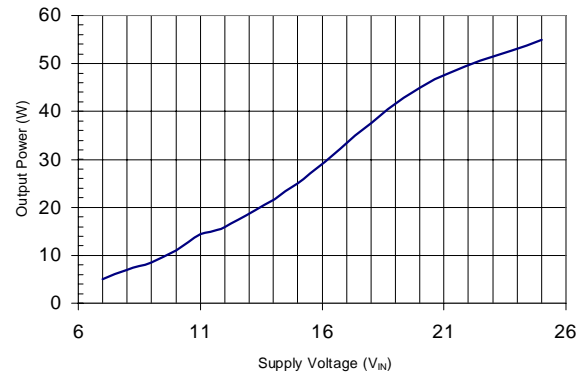

$f_{IN} = 1kHz$   
 $R_L = 4\Omega$   
 THD+N=1%

FREQUENCY RESPONSE

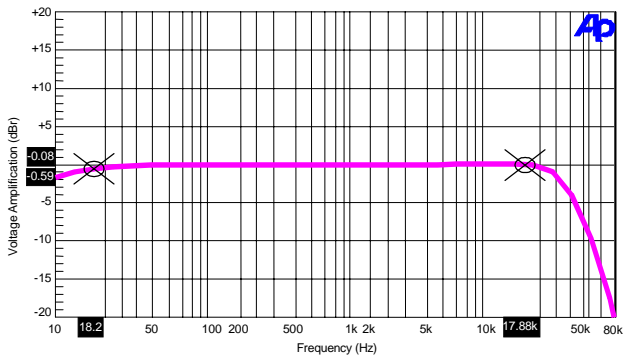

$V_{IN} = 15V$   
 $R_L = 4\Omega$   
 $R_O = 1W_{RMS}$

THD+N VS. OUTPUT POWER

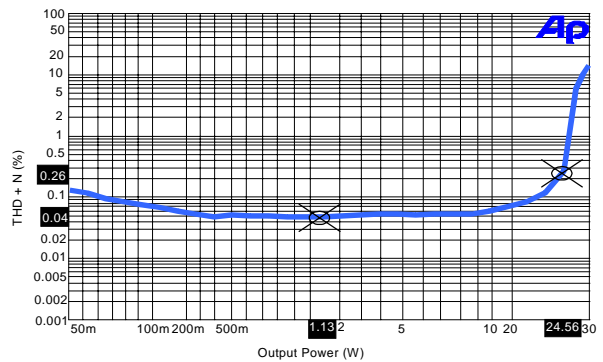

$V_{IN} = 15V$   
 $f_{IN} = 1kHz$   
 $R_L = 4\Omega$



## APPLICATION INFORMATION

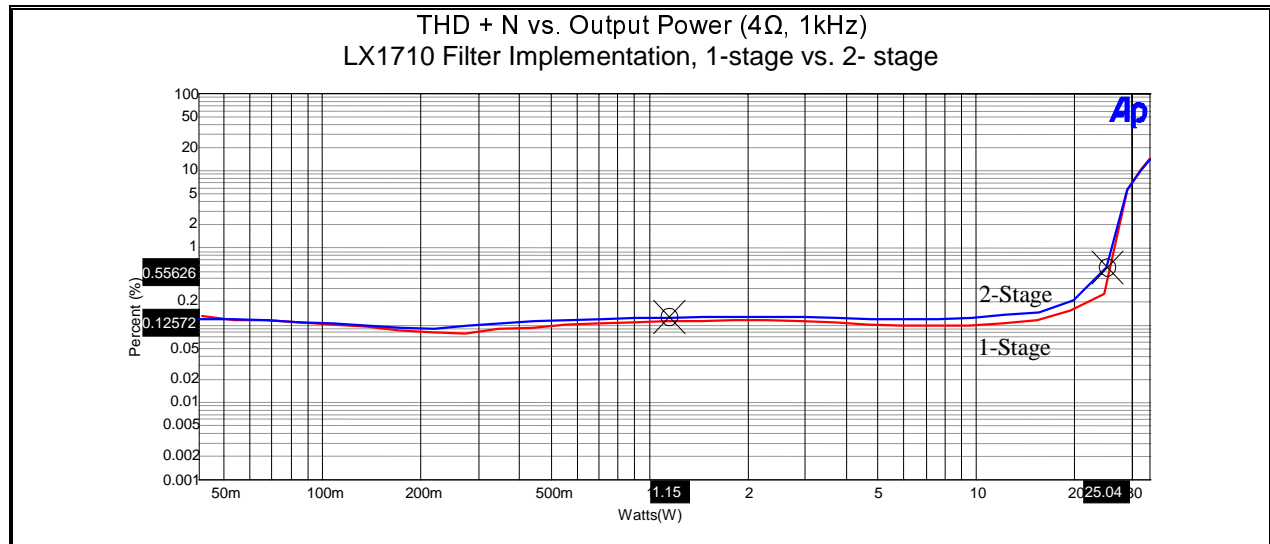

### FILTER DESIGN TRADEOFFS (1-STAGE VS. 2-STAGE)

A 1-stage or 2-stage filter may be used depending on your application and performance targets. The main tradeoff in this selection is price (number of components, component costs, PCB area) vs. performance. The primary advantage of the single stage filter is lower cost whereas the main benefit to a 2-stage filter is that it will provide steeper attenuation. This allows the corner frequency to be selected further outside of the audio band (to minimize the effects of impedance variations in the passband) and still provide adequate RF attenuation.

#### Single Stage Filter Advantages

- **Low Cost:** The 1-stage LC filter uses one half the number of inductors/capacitors resulting in a substantial cost savings over a 2-stage design. Key parameters such as THD+N, frequency response, and noise performance do not change significantly.
- **Power Loss:** Since current will flow in two inductors and not four, the inductor power loss will be less in the single stage design. The overall amplifier will have a wider dynamic range and improved efficiency.
- **Filter Design:** This easy-to-design filter can limit audio signal changes within +/- 3dB across the audio band with impedance variance from 2Ω to approximately 8Ω. Due to a steeper rolloff with the 2-stage filter,

impedance changes could result in a +/- 6dB change.

- **THD:** There are minimal differences between the 1-stage and 2-stage implementations with other parameters such as THD+N as seen in the above graph.

#### Single Stage Filter Disadvantages

- **EMI and Switching Frequency:** For the 1-stage, the switching frequency must be higher than 400kHz to ensure the corner frequency will provide adequate amplifier performance in the high end of the audio frequency range. If  $f_s < 400\text{kHz}$ , then  $f_c < f_s / 10 = 40\text{kHz}$  which is too close to the desired audio band. A higher oscillation frequency could translate into greater MOSFET switching losses, slightly lower efficiency, and increased EMI effects. With a 2-stage 4th order filter, the switching frequency  $f_s$  can be reduced to 120kHz. If  $f_s = 120\text{kHz}$ , then  $f_c = f_s / 3 = 40\text{kHz}$ . The lower oscillation frequency could help minimize EMI issues.

### LC FILTER DESIGN

The output filter helps to reconstruct the amplified audio signal and filter out the switching frequency. The design of the filter depends on the type of attenuation and frequency response desired at the output. The output filter designed into the LXE1710

evaluation board is a second order, LC type filter as shown below. Tradeoffs between performance and component cost must be considered when determining the complexity or type of filter selected.

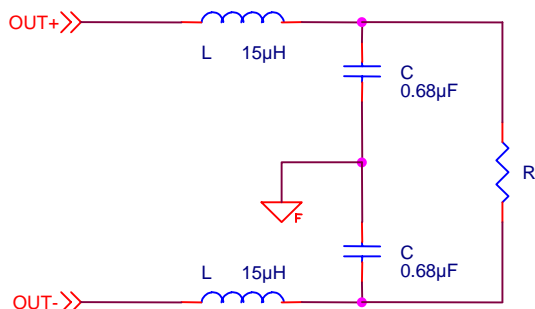

Its Laplace Transform function is:

$$H(S) = \frac{\frac{S}{C}}{S^2 + \frac{1}{RC}S + \frac{1}{LC}} = \frac{\frac{S}{C}}{S^2 + \frac{\omega}{Q}S + \omega^2}$$

Where  $\omega = \frac{1}{\sqrt{LC}}$

$$Q = RC\omega$$

The Class-D amplifier evaluation board design has a pass-band of 20Hz to 20kHz to support the audio frequency range and is configured to utilize a switching or oscillator frequency  $f_s = 500\text{kHz}$ . Depending on the application, this oscillator frequency may be adjusted (see section on Oscillator Configuration) to optimize amplifier performance or modified for other considerations such as EMI effects. Further requirements of the filter are that the pass band attenuation of switching frequency  $f_s$  should be lower than 40dB and the corner frequency of the LC filter should be set higher than 20kHz to avoid attenuating audio signals in the desired audio band by more than 1dB. A speaker DC impedance of 4Ω with an  $f_c = 50\text{kHz}$  corner frequency are defined for the evaluation board.

The Q (selectivity factor or ratio of the center frequency divided by the bandwidth) of the filter must also be considered when designing a filter. Too high a Q will result in a boost of the audio signal across the audio band whereas a low Q will cause too much attenuation of the signal. A Q value of 0.707 provides

the required audio response and is used in the calculation below.

$$C = \frac{Q}{R\omega} = \frac{Q}{R(2\pi f_c)} = \frac{0.707}{4(2\pi)(50000)} = 0.56\mu\text{F}$$

$C = 0.68\mu\text{F}$  is used in the Evaluation Board

To Compute the Inductor Value:

$$L = \frac{1}{\omega^2 C} = \frac{1}{(2\pi f_c)^2 C} = \frac{1}{[(2\pi)(50000)]^2 (.68\mu)} = 14.9\mu\text{H}$$

$L = 15\mu\text{H}$  is used in the Evaluation Board

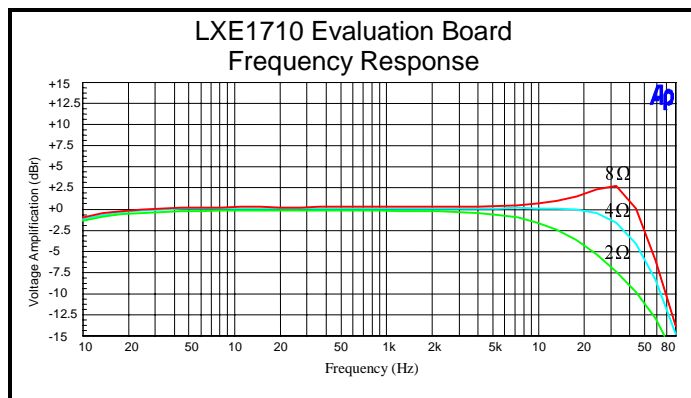

Frequency response of the audio amplifier was measured using various speaker load impedances 2Ω, 4Ω, and 8Ω. The graphs verify that the filter calculations were based on a 4Ω speaker. The 8Ω and 2Ω curves display a 2dB boost and a -4dB attenuation respectively. Therefore, to improve frequency response performance for other loads, the value of Q must be increased/decreased by changing the capacitor. Since a different value C will affect the corner frequency, values for L and C must be recalculated. Below are recommended inductor and capacitor values for 2Ω, 4Ω, and 8Ω loads for this single stage LC filter design.

	Capacitor C (µF)	Inductor L (µH)
2Ω	1.0	10
4Ω	0.68	15
8Ω	0.47	22

**Table 2:** Filter Component Values

**Please note:** These recommended values are guidelines for speaker loads. Actual speakers have varying impedances, which may require revised filter calculations and optimization. Furthermore, your application may have different design goals than those chosen for the LX1710 evaluation board.

MOSFET SELECTION

As seen in previous sections, the user can design the output filter of the amplifier to meet performance or costs targets. In addition, the amplifier's power stage (selection of MOSFETs) can be selected depending on these tradeoffs. The efficiency of the amplifier circuit can be approximated by the following equation.

$$\eta = \frac{P_{OUT}}{P_{IN}} = \frac{I^2 R_L}{I^2 [2(R_{NDS} + R_{PDS} + R_{IND}) + R_L] + P_{CROSS}}$$

Where

- $R_L$  = DC Resistance of Speaker
- $R_{NDS}$  = n-channel MOSFET on-resistance
- $R_{PDS}$  = p-channel MOSFET on-resistance
- $R_{IND}$  = DC Resistance of Inductor
- $P_{CROSS}$  = MOSFET Switching Loss

The overall efficiency is a function of primarily the MOSFETs and output filter inductors. The "Inductor" section's contribution will be considered later. The MOSFET Power loss is a function of the on-resistance and gate charge.

On-Resistance,  $R_{DS}$ :

$$\text{MOSFET Power Loss} = P_{DS} = I^2 [2(R_{NDS} + R_{PDS})]$$

$$\text{If } P_o = 25W \text{ at } 4\Omega$$

$$\text{Then } I = \sqrt{\frac{P}{R}} = \sqrt{\frac{25}{4}} = 2.5A$$

The LX1710 Evaluation Board is designed using FDS4953 p-channel and FDS6612A n-channel MOSFETS.

$$R_{NDS} = 0.03\Omega, R_{PDS} = 0.095\Omega$$

$$P_{DS} = (2.5)^2 [2(0.03 + 0.095)] = 1.56W$$

MOSFET power loss is proportional to on-resistance.

Total Gate Charge,  $Q_g$ :

$$\text{MOSFET Switching Loss} = P_{CROSS} = CV^2 f_s n$$

Where

- $C$  = Input Capacitance
- $V$  = Supply Voltage
- $f_s$  = Switching Frequency
- $n$  = Number of MOSFETS

- Assume
- $C$  = 1000pF
  - $V$  = 15VDC
  - $f_s$  = 500kHz

$$P_{CROSS} = (1 \times 10^{-9})(15^2)(500 \times 10^3)(4) = 0.45W$$

MOSFET switching loss is proportional to total gate charge, supply voltage, and switching frequency.

There are a few other important parameters to consider when selecting the output power components besides the on-resistance and gate charge of the MOSFETs. The drain-source voltage must provide ample margin for circuit noise and high speed switching transients. Since the amplifier configuration requires output bridge operation at the supply voltage, the MOSFETs should have a drain-source voltage of at least 50% greater than the supply voltage. The power dissipation of the MOSFETs should also be able to dissipate the heat generated by the internal losses and be greater than the sum of  $P_{DS}$  and  $P_{CROSS}$ . Linfinity recommends that in selecting MOSFETS,  $R_{DS} < 0.10\Omega$  and  $Q_g < 10nC$ . The table below provides several MOSFET options.

		FDS6612A	FDS4953	Si4532ADY		IRF7105	
		n-channel	p-channel	n-channel	p-channel	n-channel	p-channel
Drain-Source On-Resistance	RDS(ON)@VGS = +/-10V (Ω)	0.022	0.053	0.053	0.08	0.10	0.25
Drain-Source Voltage	VDSS (V)	30	-30	30	-30	25	-25
Drain Current (continuous)	ID(continuous) (A)	8.4	-5	4.9	-3.9	3.5	-2.3
Total Gate Charge	Qg (typical) (nC)	9	8	8	10	9.4	10
Manufacturer		Fairchild	Fairchild	Vishay Siliconix	Vishay Siliconix	International Rectifier	International Rectifier

**Table 3:** MOSFET Component Options

INDUCTOR SELECTION

The output filter inductors are key elements in the performance of the Class-D audio power amplifier.

Inductor selection criteria also involves tradeoffs between performance (efficiency) and component costs. The critical specifications for the inductor are the DC resistance, DC current, and peak current ratings. The inductors should be able to handle the amplifier's power as well as operate within its linear region. Saturating the inductors could decrease performance (increase THD) and even produce a short, which may damage either the circuit or the speaker.

Other variables when selecting an inductor depend on the switching frequency of the designed amplifier. A higher switching frequency implies that the corner frequency of the LC filter is higher. With a higher  $f_c$ , the inductor value is smaller.

The amplifier's application and design constraints will help determine whether the inductors are selected for size, power, or performance. Various inductors such as those that are shielded may also have different EMI effects and distortion performance.

The overall efficiency ( $\eta$ ) of the amplifier circuit is given in the previous MOSFET section. The inductor's power loss contribution is a function of the inductor's DC resistance,  $R_{IND}$ .

*Inductor DC Resistance,  $R_{IND}$ :*

$$\text{Inductor Power Loss} = P_{IND} = (I^2)(2)(R_{IND})$$

The LX1710 Evaluation board utilizes two 15 $\mu$ H radial leaded R.F. inductors from Inductor Supply, Inc. (ISI). When evaluating component options, inductors such as from Coilcraft can be used for other performance / price tradeoffs. See inductor table below.

$$P_{IND} = (2.5^2)(2)(.056) = 0.7W$$

The efficiency approximation can now be completed.

$$\eta = \frac{P_{OUT}}{P_{IN}} = \frac{I^2 R_L}{I^2 [2(R_{NDS} + R_{PDS} + R_{IND}) + R_L] + P_{CROSS}}$$

$$\eta = \frac{I^2 R_L}{P_{DS} + P_{IND} + P_{CROSS} + I^2 R_L}$$

$$\eta = \frac{25}{1.56 + .7 + .45 + 25} = 90.2\%$$

The efficiency is a function of the power and switching loss in the MOSFETs and inductors.

Manufacturer	Part Number	Inductance ( $\mu$ H)	Q min	Test Frequency	DC Resistance max (m $\Omega$ )	DC Current max (A <sub>RMS</sub> )	Self Resonant Frequency min (MHz)
ISI	RL622-150K	15.0	50	2.520MHz	56	2.50	12.0
Coilcraft	DO5022P-153HC	15.0		100kHz	32	4.4	20

**Table 4:** Inductor Component Options

CAPACITOR SELECTION

The LC filter design section discusses filter options and the calculation of component values. However, the specification of capacitor type depends on the application in the circuit. The table provides descriptions and guidelines for capacitors in the AudioMAX amplifier board.

Reference Designator	Capacitor	Comments
<b>C10, C11</b>	FET gate drive	These 4.7 $\mu$ F tantalum capacitors are charge transfer capacitors for the FET gate drive.
<b>C3 C14</b>	Audio input path	These decoupling capacitors are used for the audio input +/- signals.
<b>C18, C19, C20, C21</b>	Output filter	The output filter metal film capacitors (low ESR, 5% tolerance) work well to set an accurate corner frequency at a low cost.
<b>C8, C12</b>	FET bypass	These metal film capacitors are used for the power supply bypass for the FETs. Place adjacent to the FETs or consider lower value ESR solutions depending on the PCB component placement.
<b>C22</b>	LX1710 bypass	The metal film capacitor is a high frequency bypass for the LX1710 IC.
<b>C9, C13</b>	VDD, PVDD bypass	These tantalum capacitors provide the bypass for the IC supply voltage and output driver supply voltage utilizing a minimal footprint area.
<b>C17</b>	Output power stage	The electrolytic filter capacitor smoothes out ripple current and should be placed close to the output FETs.
<b>C16</b>	Oscillator frequency	The timing capacitor (5% tolerance) sets the oscillator frequency.
<b>C6, C7</b>	Feedback filter	These (5%) capacitors are used in the RC filter to provide feedback for the control loop.
<b>C4, C5</b>	Error amplifier	These (5%) capacitors create the compensation network. Make sure the appropriate "temperature grade" is used to ensure stability.
<b>C1, C2</b>	Voltage references	The filter capacitors provide the bypass for the 5V and 2.5V references.
<b>C26</b>	Audio input filter	The RC filter minimizes high frequency noise to the amplifier.

**Table 5:** Capacitor Description

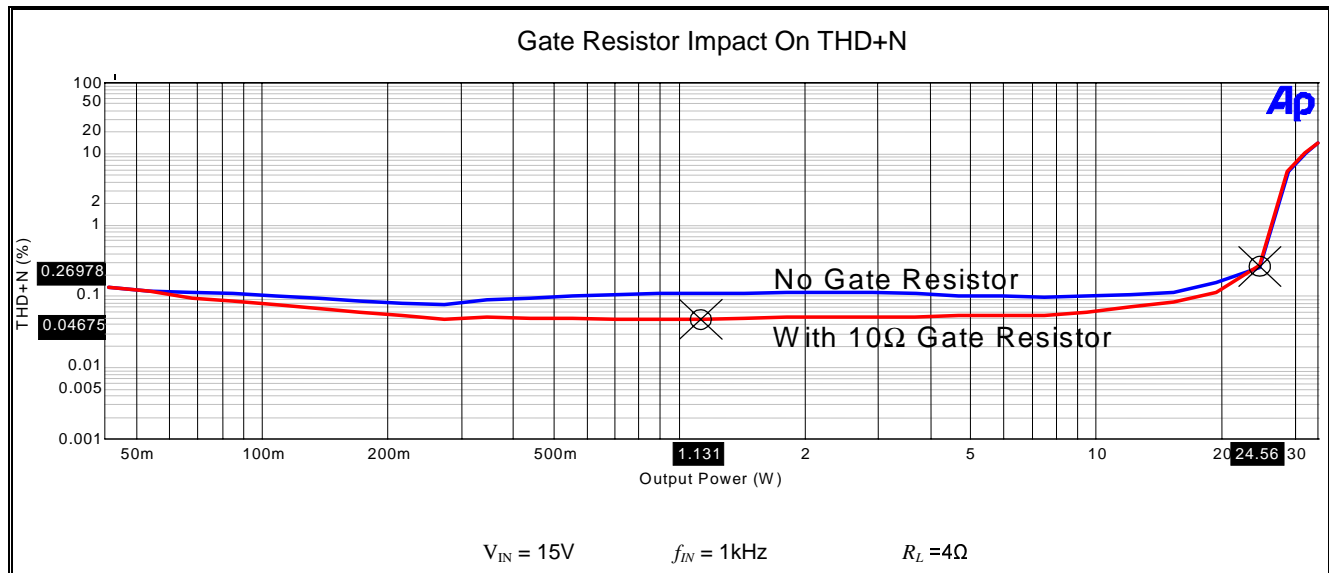

### GATE RESISTOR

Series resistors (R6, R10, R11, R12) can be added to the gate of MOSFETs (Q1 to Q4) to control the switching transition times. This reduces signal distortion as seen in the THD+N vs. Output Power graph below. The slower switching speeds will however, increase power dissipation and therefore slightly decrease the overall efficiency of the amplifier.

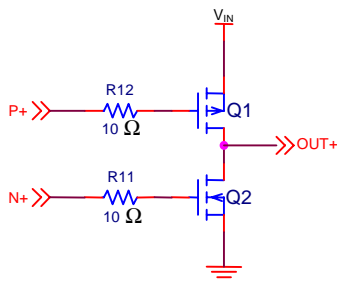

The LXE1710 evaluation board utilizes 10Ω gate resistors, which improves (decreases) the THD+N from 0.1% to 0.05% with a slight impact on efficiency of approximately 2%. The recommended gate resistor is from 0 to 15Ω.

### OSCILLATOR CONFIGURATION

The oscillator is programmed by the external timing components RPWM and CPWM. For a nominal frequency of 333kHz, RPWM and CPWM should be set to 49.9kOhms and 100pF respectively. Note that in order to keep the slope of the PWM ramp voltage proportional to the supply voltage, both the ramp peak

and valley voltages, and the charge and discharge currents are proportional to the supply voltage. This keeps the frequency relatively constant while keeping the slope of the PWM ramp proportional to the voltage on the VDD pin. For operating frequencies other than 333kHz, the frequency can be approximated by the following equation:

$$\text{Frequency} = \frac{1}{(0.577)(R_{PWM})(C_{PWM}) + 320ns}$$

### MULTI CHANNEL REQUIREMENTS AND FREQUENCY SYNCHRONIZATION

For applications that require more than a single channel, the oscillators of multiple LX1710/1711 controllers can be configured for synchronous operation. One unit, the master, is programmed for the desired frequency with the RPWM and CPWM as usual. Additional units will be slave units, and their oscillators will be disabled by leaving the RPWM pin disconnected. The CLOCK pin and the CPWM pin of the slave units should be tied to the CLOCK pin and the CPWM pin of the master unit respectively. In this configuration, the CLOCK pins of the slave units begin receiving instead of transmitting clock pulses. Also, the CPWM pins quit driving the PWM capacitor in the slave units. Note that for optimum performance, all slave units should be located within a few inches of the master unit.

### PCB LAYOUT RECOMMENDATIONS

Like most analog circuits, component placement, signal routing, and power/ground isolation can affect the overall performance of the design. The layout should utilize individual ground traces/planes for the audio amplifier whenever possible. The audio input and controller ground, FET ground, and output filter ground are routed using a “star” connection in the LXE1710 evaluation board. See PCB layer views. The power to the controller IC should be routed using separate traces that do not carry high current pulses

from the switching circuit. In general, minimizing the high frequency, high power currents from flowing through the same copper as the audio signal references are recommended. Signal traces that could be sensitive to noise should be node to node connections (no “shared” traces). Stray capacitance at the controller pins RPWM, EAOUT, EAIN, and FAOUT can affect the circuit performance and components associated with these pins should be placed as close to the controller IC as possible.

PRINTED CIRCUIT BOARD LAYOUT

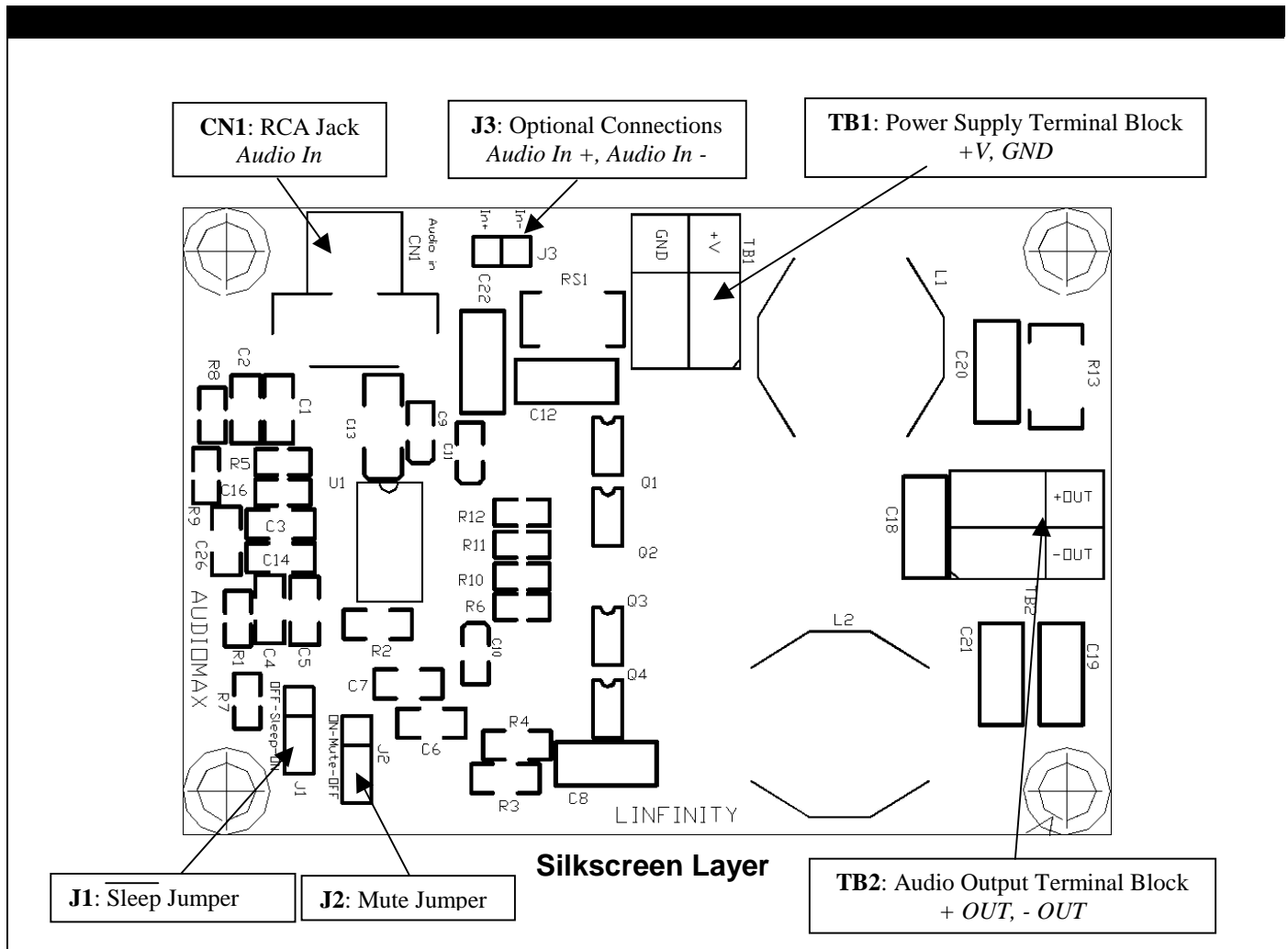



PRINTED CIRCUIT BOARD

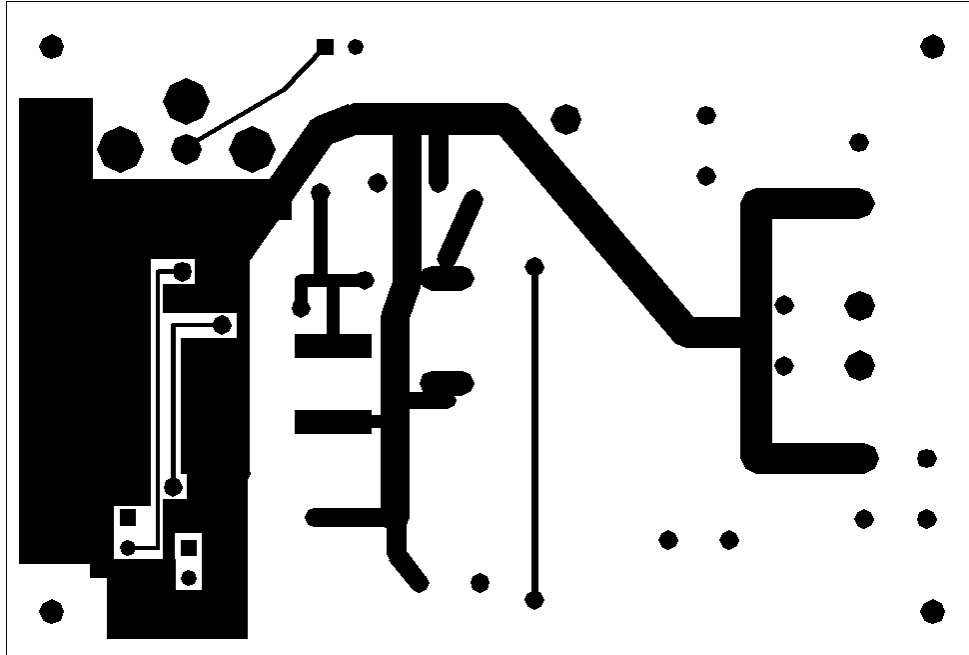

Bottom Layer

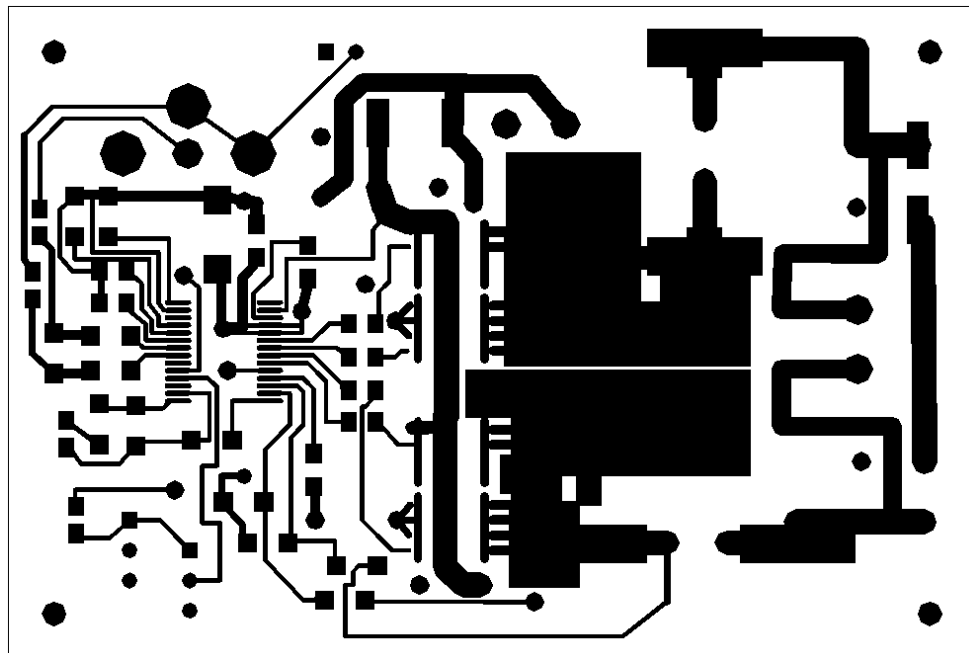

Top Layer

## BILL OF MATERIALS

## MISCELLANEOUS COMPONENTS

Line Item	Part Description	Manufacturer & Part #	Case	Reference Designators	Qty
1	Controller	LINFINITY LX1710	SSOP 28	U1	1
2	N-Channel MOSFET	FAIRCHILD FDS6612A	SO-8	Q2, Q4	2
3	P-Channel MOSFET	FAIRCHILD FDS4953	SO-8	Q1, Q3	2
4	Printed Circuit Board	LINFINITY SGE2758		REV.X	1
5	Inductor, 15uH	ISI RL622-150K	TH	L1, L2	2
6	Phono Jacks, 90° Nickel Plated, Wht	MOUSER 161-4214	TH	CN1	1
7	Strip Line Plugs, Straight, Single Row .100"	CA CA-S36-24B-44	TH	J1, J2	2
8	Shorting Jumpers, Open Top, Black	MOUSER 151-8030	TH	J1	1
9	Terminal Block 2 pos 5mm	BLOCK MASTER 301-021-1000	TH	TB1, TB2	2

## CAPACITORS

Line Item	Part Description	Part Description	Case	Reference Designators	Qty
1	Capacitor, COG, 18pF, 50V, 5%	NOVACAP 1206N180J500NT AVX 12065C180JAT2A	1206	C5	1
2	Capacitor, COG, 150pF, 50V, 5%	NOVACAP 1206N151J500NT AVX 12065C151JAT2A	1206	C4	1
3	Capacitor, COG, 220pF, 50V, 5%	AVX 12065C221JAT2A	1206	C6, C7	2
4	Capacitor, X7R, 330pF, 50V, 10%	PANASONIC ECU-V1H331KBM	1206	C26	1
5	Capacitor, X7R, .47uF, 16V, 20%	NOVACAP 1206B474M160NT AVX 1206YC474MAT2A	1206	C3, C14	2
6	Capacitor, X7R, 1uF, 50V, 10%	NOVACAP 1206B105K500NT AVX 12065C105KAT2A	1206	C1, C2	2
7	Capacitor, COG, 100pF, 50V, 5%	NOVACAP 0805N101J500NT AVX 08055C101JAT2A	0805	C16	1
8	Capacitor Tant 0.1uF 35V 20%	AVX TAJA104M035R	3216	C9	1
9	Capacitor Tant 2.2uF 25V 20%	KEMET T491A225M025AS	3216	C13	1
10	Capacitor, Tant, 4.7uF, 16V, 20%	KEMET T491A475M016AS AVX TAJA475M016R	3216	C10, C11	2
11	Capacitor Stacked MF 0.1uF 50V 5%	PANASONIC ECQ-V1H104JL	TH	C8, C12, C22	3
12	Capacitor Stacked MF 0.47uF 50V 5%	PANASONIC ECQ-V1H474JL	TH	C18, C19	2
13	Capacitor Stacked MF 0.68uF 50V 5%	PANASONIC ECQ-V1H684JL	TH	C20, C21	2
14	Capacitor, Elect 220uF, 25V, 20%	ELNA RV-25V221MH10-R	NT	C17	1

## RESISTORS

Line Item	Part Description	Part Description	Case	Reference Designators	Qty
1	Resistor, 10K, 5%, 1/4W	ASJ CR32J103T	1206	R2	1
2	Resistor, 24.3K, 1%, 1/4W	ASJ CR32F2432T	1206	R3, R4	2
3	Resistor, 10 Ohm, 5%, 1/8W	ASJ CR J100T	0805	R6, R10, R11, R12	4
4	Resistor, 10K, 5%, 1/8W	ASJ CR21J103T	0805	R8, R9	2
5	Resistor, 34.8K, 1%, 1/8W	ASJ CR21F3482T	0805	R5	1
6	Resistor, 20K, 5%, 1/8W	ASJ CR J203T	0805	R7	1
7	Resistor, 56.2K, 1%, 1/8W	ASJ CR21F5622T	0805	R1	1
8	Resistor, 15 Ohm 5% 1W	KOA RM73B3A150J ROHM MCR100JZHJ150	2512	R13	1
9	Resistor, Low Value Flat .0374	IRC LR2010-01-R0374-F	2512	RS1	1