

# T-GAGE® M18T Series Sensor



## Datasheet

### 18 mm Sensor with Discrete Output and TEACH Configuration

To view or download the latest technical information about this product, including specifications, dimensions, accessories, and wiring, see [www.bannerengineering.com](http://www.bannerengineering.com).

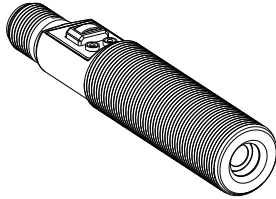

- Fast 25 ms response time with up to 20 Hz switching speed
- Easy-to-use TEACH configuration without potentiometer adjustments
- Small, self-contained package; no auxiliary controller needed
- Rugged encapsulated design for harsh environments
- Choice of 2 meter or 9 meter unterminated cable, or 5-pin M12/Euro-style quick disconnect
- Product motion not required for sensing
- Remote configuration available in both Static and Dynamic modes



#### WARNING: Not To Be Used for Personnel Protection

**Never use this device as a sensing device for personnel protection. Doing so could lead to serious injury or death.** This device does not include the self-checking redundant circuitry necessary to allow its use in personnel safety applications. A sensor failure or malfunction can cause either an energized or de-energized sensor output condition.



#### AVERTISSEMENT: A ne pas utiliser en guise de protection individuelle

Ce produit ne doit pas être utilisé en tant que système de détection destiné à la protection individuelle. Une utilisation dans de telles conditions pourrait entraîner des dommages corporels graves, voire mortels. Ce produit n'est pas équipé du circuit redondant d'autodiagnostic nécessaire pour être utilisé dans des applications de protection personnelle. Une panne du capteur ou un mauvais fonctionnement peut entraîner l'activation ou la désactivation de la sortie.

## Models

Model	Connection <sup>1</sup>	D:S Ratio	Sensing Face	Supply Voltage	Output
M18TB8	2 m (6.5 ft) unterminated 5-wire shielded cable	8:1	Integrated lens	10 to 30 V dc	Bipolar (NPN and PNP)
M18TB8Q	Integral 5-pin M12/Euro-style quick disconnect				
M18TB6E	2 m (6.5 ft) unterminated 5-wire shielded cable	6:1	Enclosed plastic face (for food industry use)		
M18TB6EQ	Integral 5-pin M12/Euro-style quick disconnect				
M18TB14	2 m (6.5 ft) unterminated 5-wire shielded cable	14:1	Germanium lens		
M18TB14Q	Integral 5-pin M12/Euro-style quick disconnect				

<sup>1</sup> To order the 9 m (30 ft) PVC cable model, add the suffix "W/30" to the cabled model number. For example, **M18TB8 W/30**. Models with a quick disconnect require a mating cordset.



## Overview

The T-GAGE analog sensor is a passive, non-contacting, temperature-based device. It is used to detect objects that are either hotter or colder than the ambient condition and then activate an output.

While it looks and operates just like an Expert™ photoelectric sensor, the T-GAGE detects the infrared light energy emitted by objects, instead of its own emitted light. The sensor uses a thermopile detector, made up of multiple infrared-sensitive elements (thermocouples) to detect this infrared energy within its field of view (see [Figure 2](#) on page 3).

Potential applications include:

- Hot part detection (baked goods, metals, bottles)
- Ejection verification of injection-molded parts
- Flame process verification
- Hot glue detection (packaging equipment, book binding)
- Cold part detection (frozen foods, ice, dairy)
- Roller monitoring

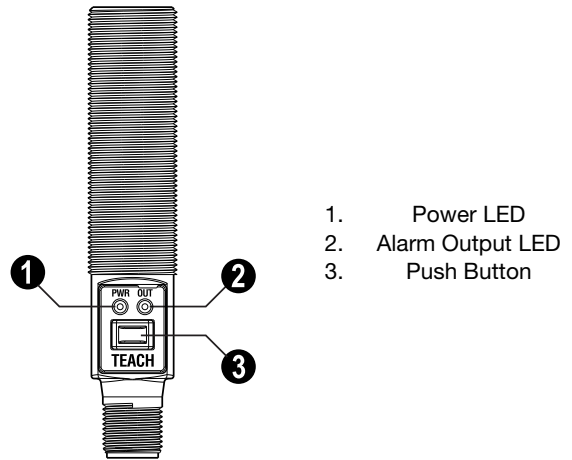

Figure 1. Sensor Features



**Note:** The T-GAGE M18T sensor is not intended for absolute temperature measurement or for safety-related fire detection use.



**Note:** Le T-GAGE M18T n'est pas conçu pour une mesure de température absolue ni pour une utilisation dans le cadre de sécurité pour la détection de feu.

## Indicators

Power ON/OFF LED	Indicates	Output LED	Indicates
OFF	Power is OFF	OFF	<b>Run Mode:</b> Output is OFF <b>2-Point TEACH active:</b> Waiting for Output OFF condition
ON Green	Sensor is in Run mode	ON Amber	<b>Run Mode:</b> Output is energized <b>2-Point TEACH active:</b> Waiting for Output ON condition
ON Red	TEACH is active	Flashing Amber	Dynamic TEACH active

## Sensing Field of View

Sensing range is determined by the sensor's field of view or viewing angle, combined with the size of the object(s) being detected. See [Figure 2](#) on page 3. The sensor's distance-to-spot size ratio (D:S ratio) is inversely related to the viewing angle; a sensor with a small viewing angle will have a large D:S ratio. The T-GAGE M18T sensors have D:S ratios of 6:1, 8:1 or 14:1. For a sensor with an 8:1 D:S ratio, the sensor spot size is a 1" diameter circle at a distance of 8"; farther from the sensor face the spot size will be larger.

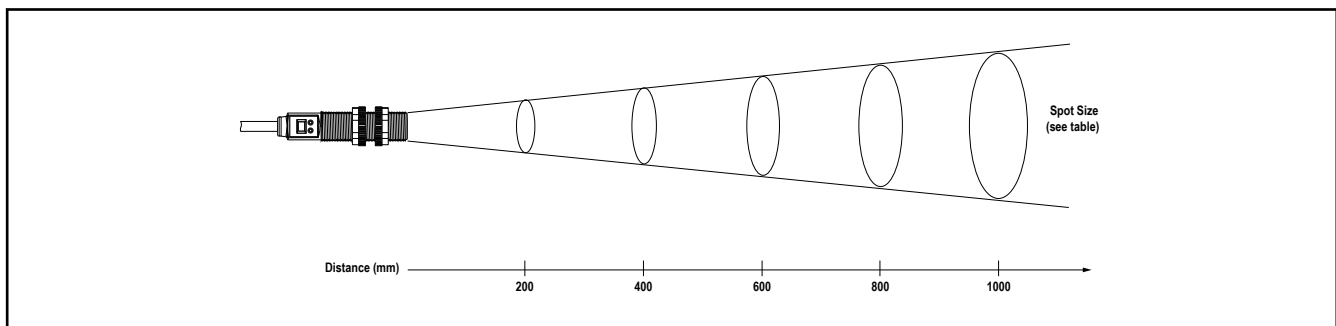

Sensor D:S Ratio	Distance from Sensor Face Versus Spot Size										Distance (mm)
	100	200	300	400	500	600	700	800	900	1000	
6:1	17	33	50	67	83	100	117	133	150	167	Spot Size (mm)
8:1	13	25	38	50	63	75	88	100	113	125	
14:1	7	14	21	29	36	43	50	57	64	71	

Figure 2. Detection spot size versus distance from sensor

## Apparent Temperature

Two factors that have a large influence on apparent temperature are the object’s emissivity and whether or not the object fills the sensor field of view.

### Object Emissivity

A “blackbody” is a “perfect” emitter, with an emissivity of 1.0 at all temperatures and wavelengths. Most surfaces emit only a fraction of the amount of thermal energy that a blackbody would. Typical T-GAGE applications will be sensing objects with emissivities ranging from 0.5 to 0.95. Many references are available with tables of emissivity coefficients for common materials. In general, shiny unpainted metals have low emissivity, while non-glossy surfaces have high emissivity.

### Shiny Surfaces

A mirror or shiny surface can redirect an object’s emitted energy to an undesired location, or even bring additional unintended thermal energy into the sensor’s field of view. See [Application Note](#) on page 7.

### Object Size

If the object being detected does not fill the sensor field of view, then the sensor averages the temperature of that object and whatever else is in the sensing field of view. For the sensor to collect the maximum amount of energy, the object should completely fill the sensor field of view. In some applications, when the object is too small, this may not be possible. In such cases, if the object is hot enough, the thermal contrast may still be adequate to trigger the sensor output.

## Installation

### Installation Note

Align the sensor toward the object to be detected. Visually align if possible, or use the alignment device accessory listed in [Additional Accessories](#) on page 8.

### Wiring Diagram

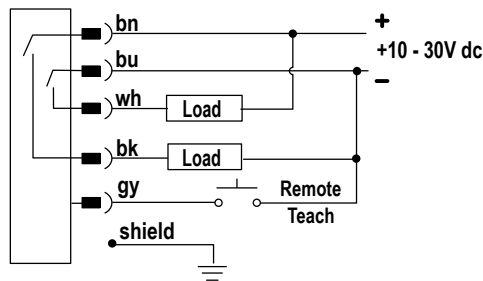

**Note:** Cabled wiring diagrams are functionally identical.



**Note:** Connect the shield wire to earth ground or dc common. Shielded cordsets are recommended for all quick disconnect models.

## Sensor Configuration

Configure the sensor using one of two TEACH methods:

- Two-Point Static TEACH
- Dynamic TEACH

Use the push button or remote input to configure the sensor.



**Note:** The duration of each remote line pulse (corresponding to a push button “click”), and the period between multiple pulses, are defined as “T”: 0.04 seconds < T < 0.8 seconds.

## Push Button Enable/Disable

The push button can be disabled using the remote input wire (gray) to prevent unauthorized adjustment. To disable the push button, connect a normally open switch between the remote input wire and dc common or connect the remote input wire to a digital output on PLC. Perform the procedure below to enable or disable the push button.

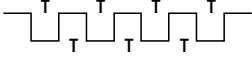
Method	Action	Result
Remote Input <sup>3</sup>	Pulse the remote line 4-times. 	The push button is enabled or disabled, depending on the previous condition.

## 2-Point Static TEACH

Use 2-Point Static TEACH configuration method for applications where both ON and OFF target conditions can be presented to the sensor statically by the operator. The sensor establishes a single sensing threshold (the switchpoint) midway between the two configured conditions, with the Output ON condition on one side and the Output OFF condition on the other.



**Note:** The sensor returns to RUN mode if the first 2-Point Static TEACH condition is not configured within 60 seconds.



**Note:** After the first condition is configured, the sensor remains in 2-Point Static TEACH configuration until the second condition is configured.

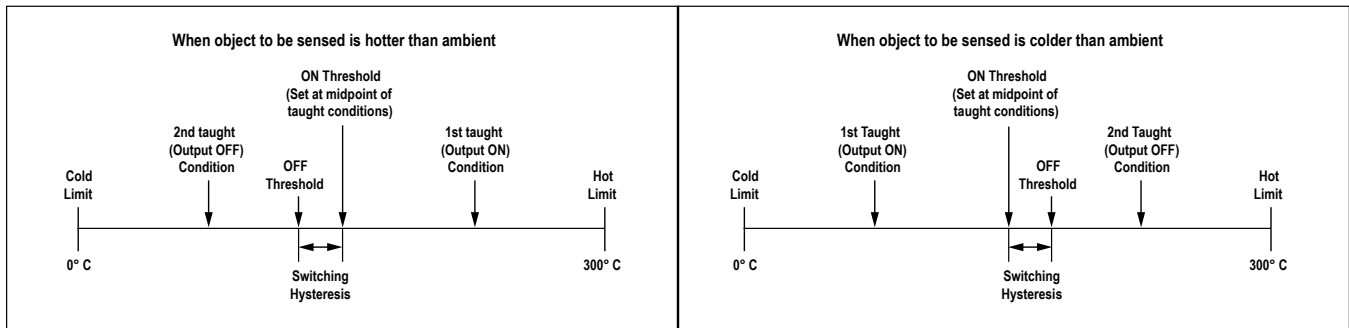





Figure 3. 2-Point Static TEACH

1. Access 2-Point Static TEACH configuration.



Method	Action	Result
Push Button	Press and hold the button for 2 seconds. 	<ul style="list-style-type: none"> <li>• Power LED turns Red</li> <li>• Output LED turns Amber</li> </ul>
Remote Input <sup>2</sup>	No action required.	

2. Present the output ON condition.

Method	Action	Result
Push Button	Press the button 1-time. 	<ul style="list-style-type: none"> <li>• Output LED turns OFF</li> </ul>
Remote Input	Pulse the remote line 1-time. 	

<sup>2</sup> 0.04 sec < T < 0.8 sec

3. Present the output OFF condition.

Method	Action		Result
Push Button	Press the button 1-time.		<b>TEACH Accepted</b> <ul style="list-style-type: none"> <li>Power LED turns Green</li> <li>The sensor configures switching threshold and returns to Run mode</li> </ul>
Remote Input	Pulse the remote line 1-time.		



**Note:** To exit 2-Point Static TEACH configuration without saving a configuration, press and hold the push button for 2 seconds or hold the remote line for 2 seconds. The sensor will return to Run mode without saving a configuration.

### Dynamic TEACH

Use Dynamic TEACH configuration method for applications where both the ON and OFF target conditions can not be presented to the sensor dynamically by the operator. After the configuration has been completed, the threshold at the midpoint is optimized by the sensor halfway between the average signals presented during the Dynamic TEACH configuration.



1. Access Dynamic TEACH configuration.

Method	Action		Result
Push Button	Press and hold the button for 2 seconds.		<ul style="list-style-type: none"> <li>Power LED turns Red</li> <li>Output LED turns Amber</li> </ul>
Remote Input <sup>3</sup>	No action required.		

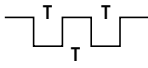
2. Present the sensing conditions.

Method	Action		Result
Push Button	Press the button 2-times.		<ul style="list-style-type: none"> <li>Sensor begins Dynamic TEACH configuration</li> <li>Output LED flashes Amber at 2 Hz</li> </ul>
Remote Input	Pulse the remote line 2-times.		

3. End Dynamic TEACH configuration.

Method	Action		Result
Push Button	Press the button 1-time.		<ul style="list-style-type: none"> <li>The sensor ends data collection; configures the threshold</li> <li>Power LED turns Green</li> <li>The sensor returns to Run mode</li> </ul>
Remote Input	Pulse the remote line 1-time.		

### Hot Operate/Cold Operate Select

Configure the sensor for Hot Operate, or Cold Operate using the remote input wire (gray). Pulse the remote line three times to toggle between Hot and Cold Operate.

<sup>3</sup> (0.04 sec < T < 0.8 sec)

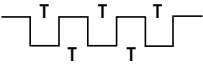
Method	Action		Result
Remote Input <sup>3</sup>	Pulse the remote line 3-times.		Hot Operate or Cold Operate is selected, depending on the previous condition.

## Specifications

### Temperature Measurement Range

0 °C to +300 °C (+32 °F to +572 °F)  
Custom ranges available upon request

### Sensing Range

Depends on object size and sensing field of view (see [Sensing Field of View](#) on page 2)

### Wavelength

8 µm to 14 µm

### Distance to Spot Size (D:S) Ratio

6:1, 8:1, or 14:1, depending on model

### Supply Voltage

10 V dc to 30 V dc (10% maximum ripple)  
35 mA maximum (exclusive of load)

### Output Configuration

One NPN and one PNP in each model

### Output Protection

Protected against short-circuit conditions

### Output Ratings

100 mA maximum (each output)  
OFF-state leakage current: NPN < 200 microamps; PNP < 10 microamps  
NPN saturation: < 200 mV at 10 mA and < 1 V at 100 mA  
PNP saturation: < 1.2 V at 10 mA and < 1.6 V at 100 mA

### Delay at Power-Up

1.5 seconds

### Output Response Time

25 ms

### Repeatability (Relative)

1 °C

### Minimum Taught Differential

3 °C

### Hysteresis

5% of taught differential (minimum 1 °C)

### Adjustments

TEACH configuration

### Indicators

One bicolor (Green/Red) status LED, one Amber LED (see [Indicators](#) on page 2)

### Remote Teach Input

Impedance: 3 kΩ

### Construction

Threaded Barrel: 304 stainless steel  
Push Button Housing: ABS/PC  
Push Button: Santoprene  
Lightpipes: Acrylic

### Operating Conditions

-20 °C to +70 °C (-4 °F to +158 °F)

### Environmental Rating

Leakproof design rated IEC IP67; NEMA 6

### Temperature Warm-Up Time

5 minutes

### Certifications



### Required Overcurrent Protection



**WARNING:** Electrical connections must be made by qualified personnel in accordance with local and national electrical codes and regulations.

Overcurrent protection is required to be provided by end product application per the supplied table.  
Overcurrent protection may be provided with external fusing or via Current Limiting, Class 2 Power Supply.  
Supply wiring leads < 24 AWG shall not be spliced.  
For additional product support, go to [www.bannerengineering.com](http://www.bannerengineering.com).

Supply Wiring (AWG)	Required Overcurrent Protection (Amps)
20	5.0
22	3.0
24	2.0
26	1.0
28	0.8
30	0.5

### Protection contre la surintensité requise



**AVERTISSEMENT:** Les raccordements électriques doivent être effectués par du personnel qualifié conformément aux réglementations et codes électriques nationaux et locaux.

Une protection de surintensité doit être fournie par l'installation du produit final, conformément au tableau fourni.  
Vous pouvez utiliser un fusible externe ou la limitation de courant pour offrir une protection contre la surtension dans le cas d'une source d'alimentation de classe 2.  
Les fils d'alimentation < 24 AWG ne peuvent pas être raccordés.  
Pour obtenir un support produit supplémentaire, rendez-vous sur le site [www.bannerengineering.com](http://www.bannerengineering.com).

Câblage d'alimentation (AWG)	Protection contre la surtension requise (ampères)
20	5.0
22	3.0
24	2.0
26	1.0
28	0.8
30	0.5

## Application Note

The following are examples of materials with high and low emissivity. Additional examples can be found online.

Sensor-Friendly Materials (High Emissivity)		Materials to Sense with Caution (Low Emissivity)
<ul style="list-style-type: none"> <li>Aluminum - anodized</li> <li>Asphalt</li> <li>Brick</li> <li>Carbon - lampblack or plate material</li> <li>Cardboard - corrugated or chipboard</li> <li>Concrete</li> <li>Glass - smooth, lead, or borosilicate (e.g., Pyrex®)</li> <li>Gypsum (including finished boards)</li> </ul>	<ul style="list-style-type: none"> <li>Ice</li> <li>Iron and steel (except bright galvanized)</li> <li>Paper - most types, regardless of color</li> <li>Styrofoam® insulation</li> <li>Plastics</li> <li>Water</li> <li>Wood - most types</li> </ul>	<ul style="list-style-type: none"> <li>Aluminum - plain or highly polished</li> <li>Copper</li> <li>Galvanized iron</li> <li>Stainless steel</li> <li>Vapor-deposited materials</li> </ul>

## Dimensions

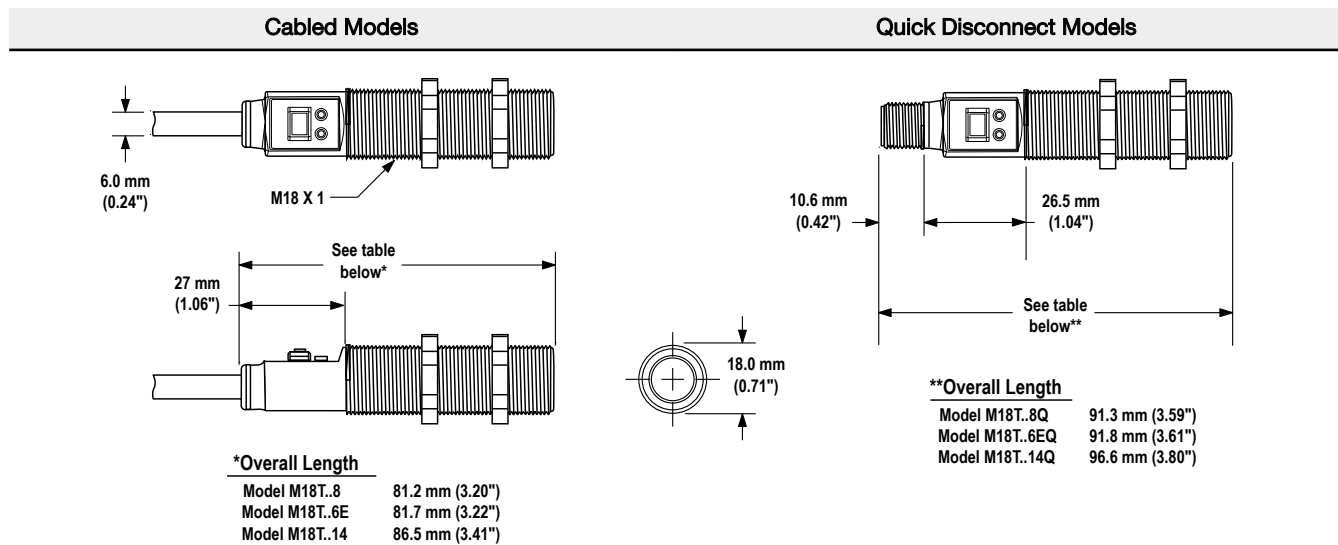

## Accessories

### Cordsets

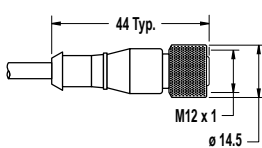
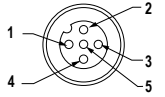
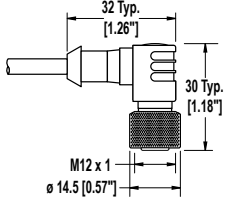
5-Pin Threaded M12/Euro-Style Cordsets—with Shield				
Model	Length	Style	Dimensions	Pinout (Female)
MQDEC2-506	1.83 m (6 ft)	Straight		 <p>1 = Brown 2 = White 3 = Blue 4 = Black 5 = Gray</p>
MQDEC2-515	4.57 m (15 ft)			
MQDEC2-530	9.14 m (30 ft)			
MQDEC2-550	15.2 m (50 ft)			
MQDEC2-506RA	1.83 m (6 ft)	Right-Angle		
MQDEC2-515RA	4.57 m (15 ft)			
MQDEC2-530RA	9.14 m (30 ft)			
MQDEC2-550RA	15.2 m (50 ft)			

## Brackets

### SMB18A

- Right-angle mounting bracket with a curved slot for versatile orientation
- 12-ga. stainless steel
- 18 mm sensor mounting hole
- Clearance for M4 (#8) hardware

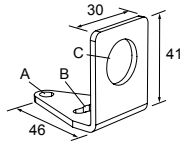

**Hole center spacing:** A to B = 24.2

**Hole size:** A =  $\varnothing$  4.6, B = 17.0 x 4.6, C =  $\varnothing$  18.5

### SMB18SF

- 18 mm swivel bracket with M18 x 1 internal thread
- Black thermoplastic polyester
- Stainless steel swivel locking hardware included

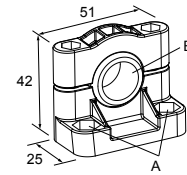

**Hole center spacing:** A = 36.0

**Hole size:** A =  $\varnothing$  5.3, B =  $\varnothing$  18.0

### SMB18UR

- 2-piece universal swivel bracket
- 300 series stainless steel
- Stainless steel swivel locking hardware included
- Mounting hole for 18 mm sensor

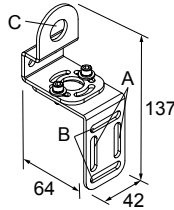

**Hole center spacing:** A = 25.4, B = 46.7

**Hole size:** B = 6.9 x 32.0, C =  $\varnothing$  18.3

## Additional Accessories

### Laser Alignment Tool - LAT1812

- Enables easy sensor alignment at long distances.
- Kit includes one SMB1812 bracket and M12 laser emitter.
- Thread bracket housing onto barrel of mounted sensor; M12 laser emitter inserted into housing provides a precise laser spot for aiming temperature sensor. (Refer to Banner data sheet p/n 122529 for more information.)
- Remove laser emitter before using sensor.



## Banner Engineering Corp. Limited Warranty

Banner Engineering Corp. warrants its products to be free from defects in material and workmanship for one year following the date of shipment. Banner Engineering Corp. will repair or replace, free of charge, any product of its manufacture which, at the time it is returned to the factory, is found to have been defective during the warranty period. This warranty does not cover damage or liability for misuse, abuse, or the improper application or installation of the Banner product.

**THIS LIMITED WARRANTY IS EXCLUSIVE AND IN LIEU OF ALL OTHER WARRANTIES WHETHER EXPRESS OR IMPLIED (INCLUDING, WITHOUT LIMITATION, ANY WARRANTY OF MERCHANTABILITY OR FITNESS FOR A PARTICULAR PURPOSE), AND WHETHER ARISING UNDER COURSE OF PERFORMANCE, COURSE OF DEALING OR TRADE USAGE.**

This Warranty is exclusive and limited to repair or, at the discretion of Banner Engineering Corp., replacement. **IN NO EVENT SHALL BANNER ENGINEERING CORP. BE LIABLE TO BUYER OR ANY OTHER PERSON OR ENTITY FOR ANY EXTRA COSTS, EXPENSES, LOSSES, LOSS OF PROFITS, OR ANY INCIDENTAL, CONSEQUENTIAL OR SPECIAL DAMAGES RESULTING FROM ANY PRODUCT DEFECT OR FROM THE USE OR INABILITY TO USE THE PRODUCT, WHETHER ARISING IN CONTRACT OR WARRANTY, STATUTE, TORT, STRICT LIABILITY, NEGLIGENCE, OR OTHERWISE.**

Banner Engineering Corp. reserves the right to change, modify or improve the design of the product without assuming any obligations or liabilities relating to any product previously manufactured by Banner Engineering Corp. Any misuse, abuse, or improper application or installation of this product or use of the product for personal protection applications when the product is identified as not intended for such purposes will void the product warranty. Any modifications to this product without prior express approval by Banner Engineering Corp will void the product warranties. All specifications published in this document are subject to change; Banner reserves the right to modify product specifications or update documentation at any time. Specifications and product information in English supersede that which is provided in any other language. For the most recent version of any documentation, refer to: [www.bannerengineering.com](http://www.bannerengineering.com).

For patent information, see [www.bannerengineering.com/patents](http://www.bannerengineering.com/patents).