

M51785P, SP

3-PHASE BRUSHLESS MOTOR CONTROL

DESCRIPTION

The M51785P/SP is a semiconductor integrated circuit designed for a single-chip controller for FDD spindle motor, consisting of power amplifier, Hall amplifier, FG amplifier, oscillator and speed discriminator and various protection circuits.

The device shows superiority in speed switching function of 1 : 1.2 which enables miniaturization of motor sets and cost reduction.

FEATURES

- High-accuracy, high-stability, and adjustment-free controller is possible by digital servo
- Speed switch of 1 : 1.2 possible..... MOD
- $I_{o(peak)}=1.2A$
- 2 ENABLE systems EN, \overline{EN}

APPLICATION

FDD spindle motor (5", 3.5")

RECOMMENDED OPERATING CONDITIONS

- Supply voltage..... 10.8-12-13.2V
- Oscillating frequency..... 400-650kHz
- Ingector current..... 2.5-3-7mA
- Maximum output current..... 800mA
- FG OUT Load resistance..... 100k Ω
- FG-amplifier input signal level..... 5 or above mV_{P-P}
- Hall amplifier input signal level..... 50-100-150 mV_{P-P}

PIN CONFIGURATION (TOP VIEW)

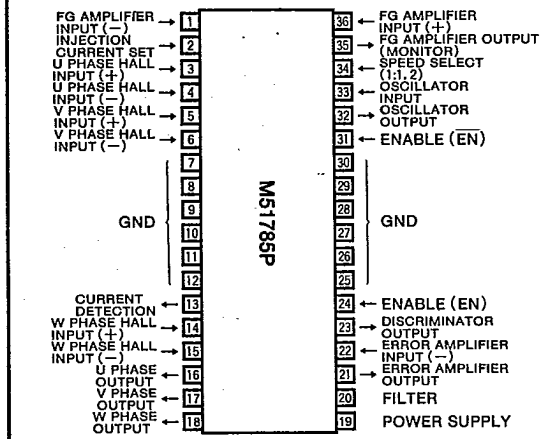

36-pin molded plastic FLAT (shrink)

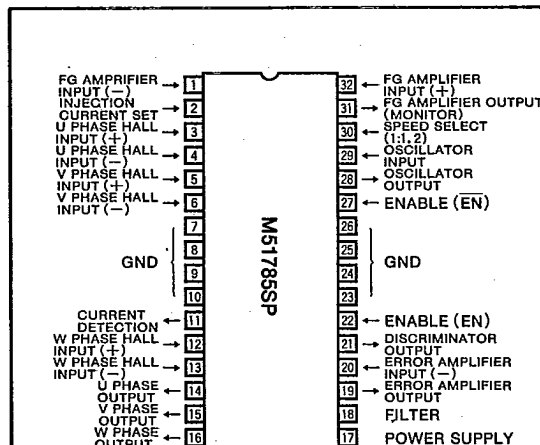

32-pin molded plastic DIP (shrink) with fin

BLOCK DIAGRAM

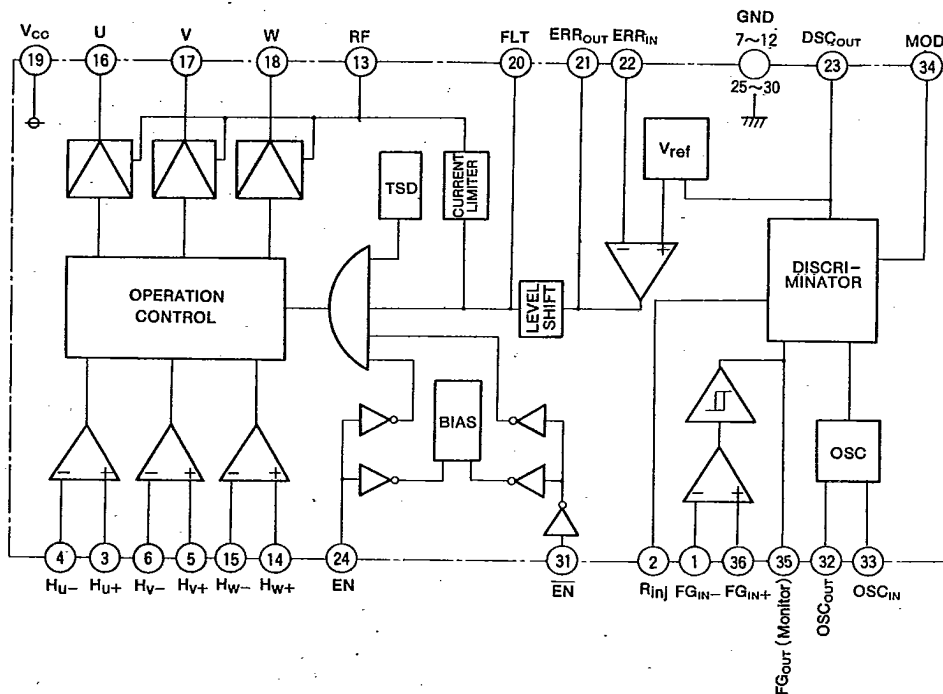

Note Pin No.=M51785P.

ABSOLUTE MAXIMUM RATINGS (Ta=25°C)

Symbol	Parameter	Conditions	Ratings	Unit
V _{CCA}	Operating supply voltage		15	V
I _O	Output current		1.2	A
V _{HD}	Hall amplifier differential input voltage	3-4, 5-6, 14-15 (Pin no.)	5	V
I _{SS}	Source/sink current	20, 21, 23, 32, 33, 36 (Pin no.)	±3	mA
V _{IN}	Pin applied voltage	1, 3, 4, 5, 6, 14, 15, 22, 24, 31, 34 (Pin no.)	0~V _{CC}	V
I _{inj}	Injection current		20	mA
V _{RF}	RF pin applied voltage		1	V
P _t	Power dissipation	Heatsink of infinite size used	4.5(8)	W
Kθ	Thermal derating	Heatsink of infinite size used	27.8(15.6)	°C/W
T _j	Junction temperature		150	°C
T _{opr}	Operating temperature		-20~+75	°C
T _{stg}	Storage temperature		-40~+125	°C
V _{COB}	Quiescent supply voltage	EN-Lo, EN-Hi.	16	V

() Shows the value of M51785SP



MITSUBISHI LINEAR ICs
M51785P.SP

6249826 MITSUBISHI ELEK (LINEAR) 80C 09034 D T-52-13-25

3-PHASE BRUSHLESS MOTOR CONTROL

ELECTRICAL CHARACTERISTICS (V_{CC}=12V, T_a=25°C, unless otherwise noted)

Symbol	Parameter	Test conditions	Limits			Unit
			Min	Typ	Max	
I _{CC} (H)	Circuit current (EN ON)	EN=2.5V, MOD=EN=0.8V, excluding injection current and FG monitor pin current. No load	9	18	28	mA
I _{CC} (L)	Circuit current (EN OFF)	Connect injection setting pin and FG monitor pin directly to V _{CC} . No load, EN=0.8V, EN=2.5V	—	90	300	μA
V _{CC} (OP)	Operating supply voltage		9	12	15	V
I _{INH} A	Hall amplifier input current		—	0.4	4	μA
V _N	Phase output middle point voltage		5.3	6.5	7.3	V
ΔV _N	Difference of middle point voltage between phases		—	—	0.2	V
V _{SAT}	Output saturation voltage	Current flow U→V, V→W, W→U. Total of V _{SAT} of T _r on both sides, I _o =0.7A	—	2.3	3.3	V
V _{TH}	Control input reference voltage	FLT pin voltage producing output	1.0	1.1	1.2	V
G _V	Voltage gain between control input and output	Source	16.65	18.06	26.81	dB
		Sink	20.82	23.80	26.81	
ΔG _V	Difference of voltage gain between phases		—	—	2	dB
V _{REF}	Error amplifier reference voltage	Measure middle level of discriminator output	2.0	2.2	2.4	V
I _{INEA}	Error amplifier input current		-2.0	-0.02	—	μA
V _{OEA}	Error amplifier output level	Hi	2.2	2.5	3.1	V
		Lo	0.6	0.8	1.05	
V _{OL}	Current limiter reference voltage	R _F pin voltage when FLT pin voltage is reduced to less than 1.5V	0.36	0.40	0.44	V
V _{IN}	Function input threshold value	Hi 24, 31, 34	2.5	—	—	V
		Lo	—	—	0.8	
I _{IN}	Input current at function input pin	V _{IN} =12V 24, 34	500	700	1000	μA
		V _{IN} =0V 31	-150	-100	-70	
V _{INJ}	Injection pin voltage	I _{inj} =6mA	0.6	0.9	1.5	V
V _{ODSC}	Discriminator output level	Hi	4.1	4.8	5.3	V
		Lo	0.5	0.8	1.2	
ΔT	Discriminator count error	+ for deceleration, - for acceleration f _{osc} =610.2kHz	-6	1	6	μsec
f _{OSC}	Oscillating frequency	f _{osc} =610.2kHz	-0.2	—	+8.2	%
I _{INJ} MAX	Maximum injection operating current	f _{osc} =610.2kHz	17	—	—	mA
I _{INJ} MIN	Minimum injection operating current	f _{osc} =610.2kHz	—	—	4	mA
V _{OL} (FG)	FG amplifier output low level (monitor)	I _L =200μA	—	0.1	0.2	V
I _I (FG)	Leak current at FG amplifier output (monitor) pin	12V is applied	—	—	1.0	μA
V _{CC} (SD)	Over-voltage protection operating voltage			16.3		V
T _(SD)	Thermal shutdown protection operating temperature			150		°C
ΔT _(SD)	Thermal shutdown protection hysteresis			25		°C
V _{IN(FG)MIN}	FG amplifier operating minimum input voltage	Measure at FG monitor pin		2.5		mV _{P-P}
V _{FG} (NM)	FG amplifier input noise margin			1.0		mV _{P-P}
N _{CLK}	Discriminator count no.	MOD=Lo	Count error is specified in section 19 of ELECTRICAL CHARACTERISTICS.		1695	—
		MOD=Hi			2034	
f _{FG1}	Synchronous frequency 1	MOD=Hi, f _{osc} =610.2kHz		300.0		Hz
f _{FG2}	Synchronous frequency 2	MOD=Lo, f _{osc} =610.2kHz		360.0		Hz

3-PHASE BRUSHLESS MOTOR CONTROL

THERMAL DERATING (MAXIMUM RATING)

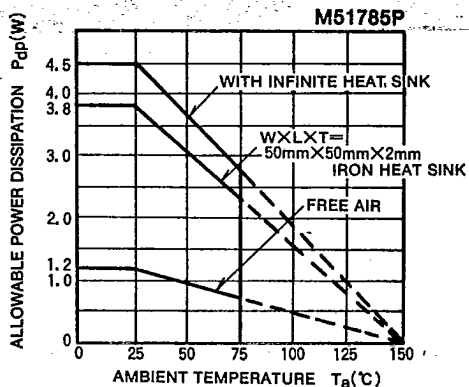

THERMAL DERATING (MAXIMUM RATING)

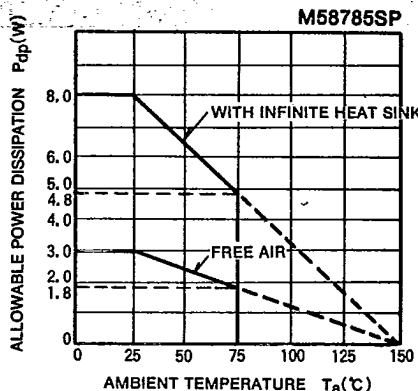

APPLICATION EXAMPLE

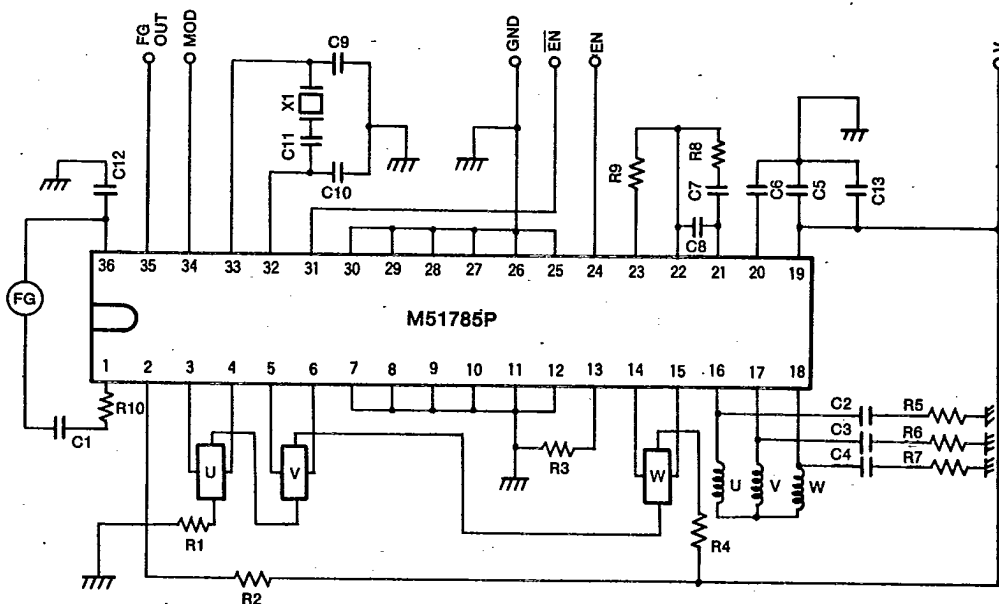

CONSTANTS

R1	330Ω	C1	4.7μF	X1	610.2kHz
R2	3.6kΩ	C2	0.1μF		
R3	0.5Ω	C3	0.1μF		
R4	330Ω	C4	0.1μF		
R5	4.7Ω	C5	0.1μF		
R6	4.7Ω	C6	0.22μF		
R7	4.7Ω	C7	0.33μF		
R8	75kΩ	C8	0.033pF		
R9	22kΩ	C9	220pF		
R10	330Ω	C10	220pF		
		C11	100pF		
		C12	0.1μF		
		C13	33μF		

Note : Open collector output at FG OUT pin



TIMING CHART

HALL INPUT

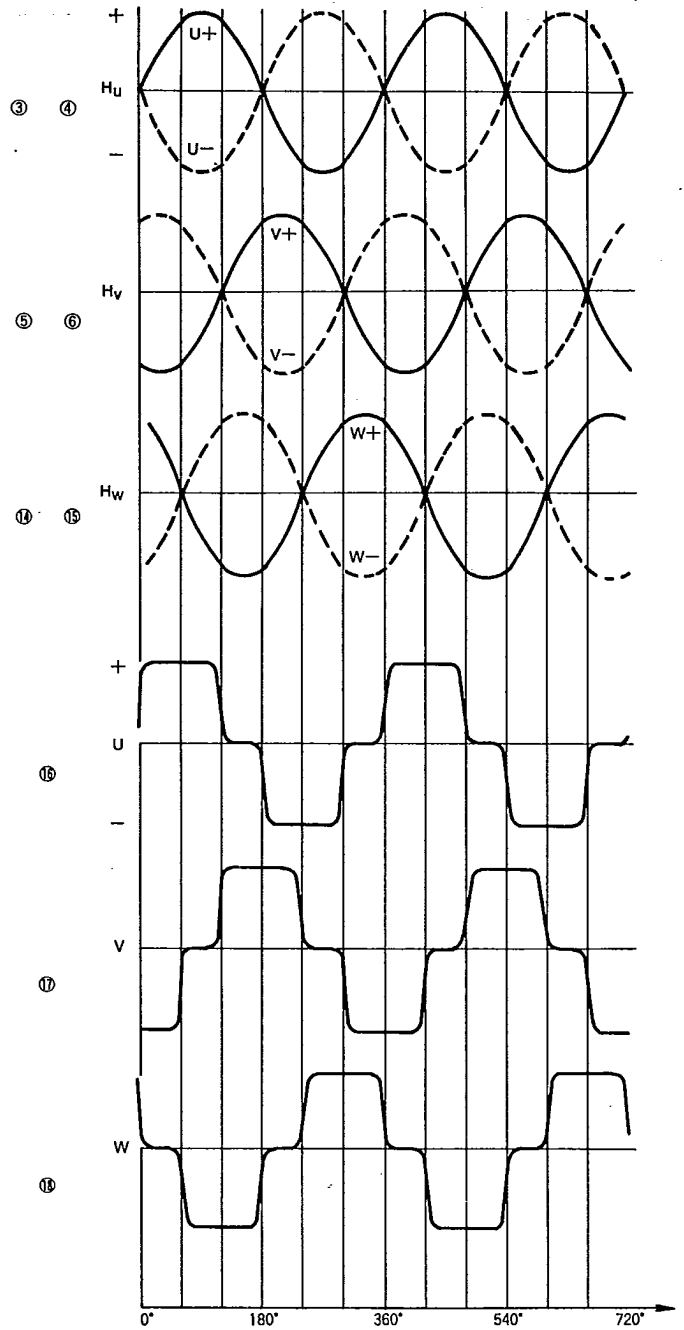

Note 1. The waveforms shown above are different from those at actual motor operation.

Note 2. Pin. No. =M51785P

TEST DESCRIPTION

Phase output middle point voltage

Difference of middle point voltage between phase

Output saturation voltage

Control input reference voltage

Voltage gain between control input and output

Difference of voltage gain between phase

→① ; Measure voltage 1 for each phase and ΔV_N is given in,

$$\begin{aligned} \Delta V_N &= \Delta V_{UV} = V_U - V_V \\ &= \Delta V_{VW} = V_V - V_W \\ &= \Delta V_{WU} = V_W - V_U \end{aligned}$$

→⑦+⑧ Load current 0.7A

Control input voltage 2.2V

→② Control input voltage value (V_{FLT}) when the output voltage is ①+100mV.

→③(source)

④(sink)

$$\textcircled{3} = 20 \log \{(V_1 - V_2) / 0.2\}$$

$$\textcircled{4} = 20 \log \{(V_3 - V_4) / 0.2\}$$

; Measure ③ and ④ for each phase, and ΔG_V is given in, (source and sink)

$$\begin{aligned} \Delta G &= \Delta G_{UV} = G_{V(U)} - G_{V(V)} \\ &= \Delta G_{VW} = G_{V(V)} - G_{V(W)} \\ &= \Delta G_{WU} = G_{V(W)} - G_{V(U)} \end{aligned}$$

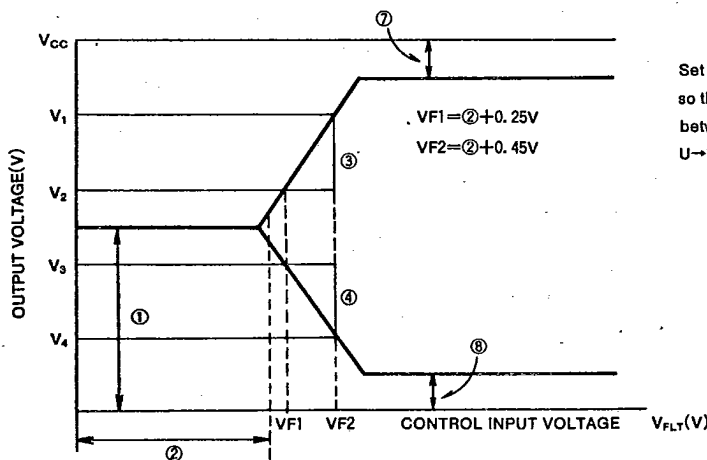

Set the values of ② to ⑥ so that the output current flows between phases U→V, V→W, W→U.

M51785P,SP

6249826 MITSUBISHI ELEK (LINEAR)

80C 09038 D T-52-13-25

3-PHASE BRUSHLESS MOTOR CONTROL

DISCRIMINATOR COUNT ERROR

Measure the pulsewidth at 23 pin DSC OUT. The test value is negative for accelerating pulse.

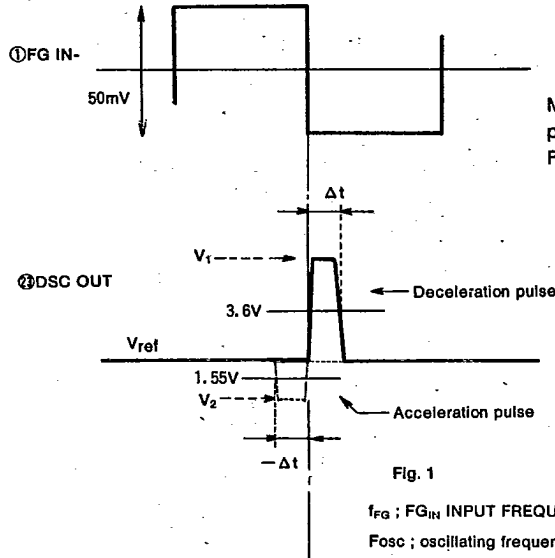

Measure acceleration or deceleration pulse at DSC_{OUT} output, applying pulse (synchronous with Fosc) divided by Fosc to FG_{IN}-in each mode.

☆Refer to table 1 for the frequency given to FG_{IN}.

Fig. 1
 f_{FG} ; FG_{IN} INPUT FREQUENCY
 Fosc ; oscillating frequency

Table 1

MOD	FG _{IN} input frequency
L 1665 division	Fosc/1695
H 2034 division	Fosc/2034

DISCRIMINATOR OUTPUT LEVEL

Measure V₁ and V₂ in Fig. 1. V_{DSC}(Hi)→V₁
 (Lo)→V₂

But, for Low(V₂) level, measure Lo level of f_{FG}=250Hz(acceleration pulse),
 and for High(V₁) level, measure Hi level of f_{FG}=400Hz (deceleration pulse).

ENABLE FUNCTION

Table 2

EN	Lo	Hi
Lo	DISABLE	ENABLE
Hi	DISABLE	DISABLE

☆EN pin=circuit is operated only when EN pin=Hi and EN pin=Lo

☆EN pin→open=Lo

EN pin→open=Hi

(But anti-noise characteristics may deteriorate if used with EN. • EN=open after mounting on the equipment.)