

M52775FP

VIF, SIF, VIDEO, CHROMA, DEFLECTION FOR NTSC

DESCRIPTION

The M52775FP is designed to provide a solution to NTSC color television system. It is an I²C bus controlled NTSC 1 chip. It consists of various processing blocks such as video IF, sound IF, luminance, chrominance, mono-sound, OSD display, interface, H and V deflection. At each block, I²C control is possible and a total of 30 parameters can be controlled by I²C bus.

FEATURES

- AFT coil-less
- FM det coil-less
- Dynamic AGC
- AV switch (TV/EXT video)
- Y/C switch
- Built-in black stretch circuit
- Delay line aperture control
- Luminance peak limiter
- Two window vertical countdown
- Built-in chroma BPF and Trap
- Built-in Y Delay line
- Built-in ACC/Killer filters

APPLICATION

NTSC type color TV, projector

RECOMMENDED OPERATING CONDITION

Recommended supply voltage.....V3, 4, 21, 22, 23=4.75V
 V5, 15, 16=8.0V
 Supply voltage range.....V3, 4, 21, 22, 23=4.50 to 5.00V
 V5, 15, 16 =7.6 to 8.8V
 Maximum output current.....3.0mA (pin14)
 4.0mA (pin13)
 8.0mA (RGB output current)
 3.0mA (AUDIO OUT output current)

PIN CONFIGURATION (TOP VIEW)

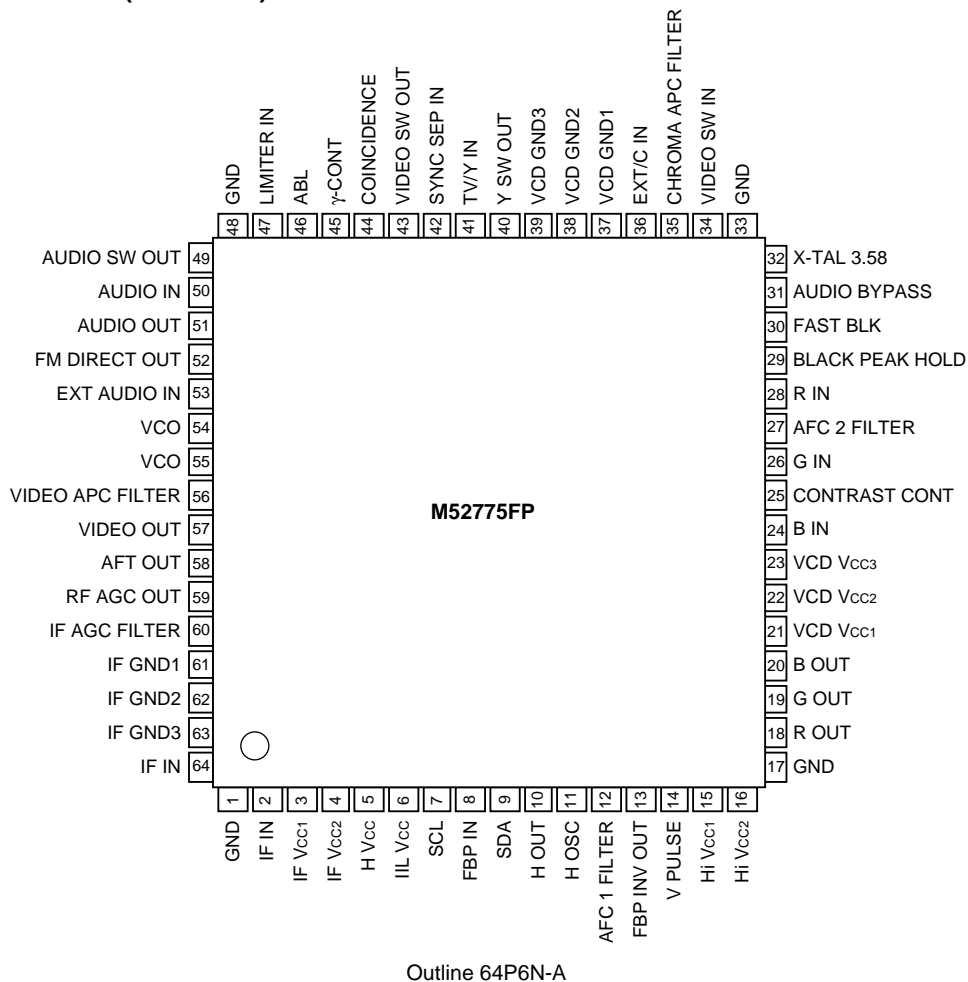

VIF, SIF, VIDEO, CHROMA, DEFLECTION FOR NTSC

BLOCK DIAGRAM

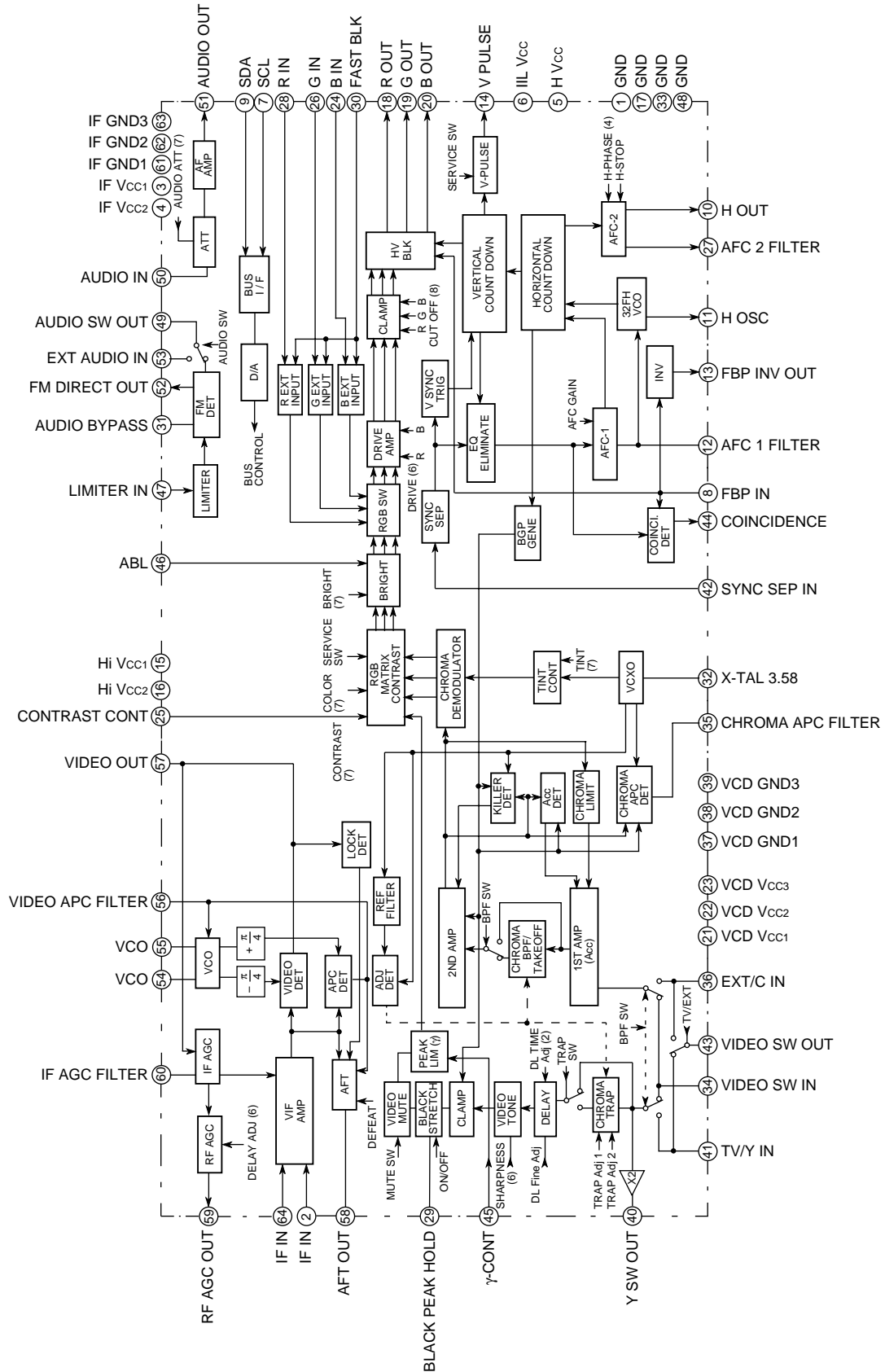

M52775FP

VIF, SIF, VIDEO, CHROMA, DEFLECTION FOR NTSC

ABSOLUTE MAXIMUM RATINGS

| Symbol | Parameter | Ratings | Unit |
|------------------|-------------------------|-------------|------|
| V _{cc} | Supply voltage | 6.0, 9.0 | V |
| P _d | Power dissipation | 0.85 | W |
| T _{opr} | Operating temperature | -20 to +65 | °C |
| T _{stg} | Storage temperature | -40 to +150 | °C |
| Surge | Electrostatic discharge | ±200 | V |

I²C BUS DEFAULT CONDITION OF ALL BLOCKS IN M52775FP

| | sub address | 00H | | 01H | | 02H | | | | 03H | 04H | | 05H | 06H | | | | 07H | | | |
|------------|-------------|-----|-----|-----|------|-----|-----|-------|------|-----|-----|-------|------|------|------|--------|-----|-------|------|------|-----|
| | function | DLA | P/N | | AVSW | | DFA | TADJ2 | TRAP | | ATT | SHARP | DEFE | CONT | DLTA | TV/EXT | Y/C | black | HADJ | TINT | |
| All Blocks | DATA | 20H | 00H | | | | | | | 40H | | 20H | 20H | | | | | | | | 40H |
| | function | 32 | 0 | | 0 | | 0 | 0 | 0 | 0 | 64 | 32 | 0 | 32 | 2 | 0 | 0 | 0 | 0 | 0 | 64 |

| | sub address | 08H | 09H | 0AH | 0BH | 0CH | 0DH | 0EH | 0FH | 10H | | | 12H | 13H | | | | | | |
|------------|-------------|-------|-----|-----|-----|-----|------|-----|-----|-----|-----|-----|-----|-----|-------|-----|-----|------|---|--|
| | function | COLOR | | HP | BRI | DR | MUTE | DB | CR | CG | CB | | TRF | | 2WIND | SER | HST | AFCG | | |
| All Blocks | DATA | 20H | 40H | 20H | 20H | 20H | 80H | 80H | 80H | | | 00H | 00H | | | 00H | | | | |
| | function | 32 | 0 | 8 | 32 | 32 | 0 | 32 | 128 | 128 | 128 | 0 | 0 | 0 | 0 | | 0 | 0 | 0 | |

* Please refer to the following sub-address data for each parameter you measure.

ELECTRICAL CHARACTERISTICS (T_a=25°C, pin3, 4, 21, 22, 23:4.75V supply/pin5, 15, 16:8V supply unless otherwise noted.)

| Symbol | Parameter | Input signal | | SW | Test conditions | | | | | | | | | | | | | | | | Limits | | | Unit | Note | | | | | | | | | | | | | | | | |
|---------------------|--------------------------------------|--------------|----|-----|-----------------|----|-----|----------------------|-----|-----|--|--|--|--|--|--|--|-----------------|---|---|--------|------|------|------|------|------|---|--|--|--|--|--|--|--|--|--|--|--|--|--|--|
| | | Input | SG | | S | S | S | Sub address function | | | | | | | | | | V _{cc} | | | | Min. | Typ. | | | Max. | | | | | | | | | | | | | | | |
| | | | | 12 | 60 | 45 | 00H | 01H | 03H | 04H | | | | | | | | | P | P | P | | | | | | P | | | | | | | | | | | | | | |
| Supply current | | | | | | | | | | | | | | | | | | | | | | | | | | | | | | | | | | | | | | | | | |
| - | Default conditions of supply current | - | - | SW | | | | | | | | | | | | | | | | | | | | | | | | | | | | | | | | | | | | | |
| | | | | PIN | | | | | | | | | | | | | | | | | | | | | | | | | | | | | | | | | | | | | |
| | | | | | | | | | | | | | | | | | | | | | | | | | | | | | | | | | | | | | | | | | |
| ICC4 | Pin3, 4, 21, 22, 23 supply current | - | - | SW | | | | | | | | | | | | | | | | | | | | | | | | | | | | | | | | | | | | | |
| | | | | PIN | | | | | | | | | | | | | | | | | | | | | | | | | | | | | | | | | | | | | |
| | | | | | | | | | | | | | | | | | | | | | | | | | | | | | | | | | | | | | | | | | |
| ICC8a | Pin5 supply current | - | - | SW | | | | | | | | | | | | | | | | | | | | | | | | | | | | | | | | | | | | | |
| | | | | PIN | | | | | | | | | | | | | | | | | | | | | | | | | | | | | | | | | | | | | |
| | | | | | | | | | | | | | | | | | | | | | | | | | | | | | | | | | | | | | | | | | |
| ICC8b | Pin 15, 16 supply current | - | - | SW | | | | | | | | | | | | | | | | | | | | | | | | | | | | | | | | | | | | | |
| | | | | PIN | | | | | | | | | | | | | | | | | | | | | | | | | | | | | | | | | | | | | |
| | | | | | | | | | | | | | | | | | | | | | | | | | | | | | | | | | | | | | | | | | |
| VIF block | | | | | | | | | | | | | | | | | | | | | | | | | | | | | | | | | | | | | | | | | |
| - | Default conditions of IF type | - | - | SW | 1 | 1 | 1 | | | | | | | | | | | | | | | | | | | | | | | | | | | | | | | | | | |
| | | | | PIN | | | | | | | | | | | | | | | | | | | | | | | | | | | | | | | | | | | | | |
| | | | | | | | | | | | | | | | | | | | | | | | | | | | | | | | | | | | | | | | | | |
| V _{dc} | Video detection output DC voltage | - | - | SW | | | | | | | | | | | | | | | | | | | | | | | | | | | | | | | | | | | | | |
| | | | | PIN | | | | | | | | | | | | | | | | | | | | | | | | | | | | | | | | | | | | | |
| | | | | | | | | | | | | | | | | | | | | | | | | | | | | | | | | | | | | | | | | | |
| V _o | Video detection output | 64 | 2 | SG1 | SW | 0 | | | | | | | | | | | | | | | | | | | | | | | | | | | | | | | | | | | |
| | | | | | PIN | | | | | | | | | | | | | | | | | | | | | | | | | | | | | | | | | | | | |
| | | | | | | | | | | | | | | | | | | | | | | | | | | | | | | | | | | | | | | | | | |
| P/N | Video S/N | 64 | 2 | SG3 | SW | 0 | | | | | | | | | | | | | | | | | | | | | | | | | | | | | | | | | | | |
| | | | | | PIN | | | | | | | | | | | | | | | | | | | | | | | | | | | | | | | | | | | | |
| | | | | | | | | | | | | | | | | | | | | | | | | | | | | | | | | | | | | | | | | | |
| V _f | Video frequency characteristics | 64 | 2 | SG4 | SW | 0 | | | | | | | | | | | | | | | | | | | | | | | | | | | | | | | | | | | |
| | | | | | PIN | | | | | | | | | | | | | | | | | | | | | | | | | | | | | | | | | | | | |
| | | | | | | | | | | | | | | | | | | | | | | | | | | | | | | | | | | | | | | | | | |
| V _{in min} | Input sensitivity | 64 | 2 | SG5 | SW | 0 | | | | | | | | | | | | | | | | | | | | | | | | | | | | | | | | | | | |
| | | | | | PIN | | | | | | | | | | | | | | | | | | | | | | | | | | | | | | | | | | | | |
| | | | | | | | | | | | | | | | | | | | | | | | | | | | | | | | | | | | | | | | | | |
| V _{in max} | Maximum permissible input | 64 | 2 | SG6 | SW | 0 | | | | | | | | | | | | | | | | | | | | | | | | | | | | | | | | | | | |
| | | | | | PIN | | | | | | | | | | | | | | | | | | | | | | | | | | | | | | | | | | | | |
| | | | | | | | | | | | | | | | | | | | | | | | | | | | | | | | | | | | | | | | | | |

VIF, SIF, VIDEO, CHROMA, DEFLECTION FOR NTSC

ELECTRICAL CHARACTERISTICS (cont.)

| Symbol | Parameter | Input signal | | SW | Test conditions | | | | | | | | | | | | | | | | | | Limits | | | Unit | Note |
|--------|----------------|--------------|------|-----------|----------------------|-----|-----|-----|-----|-----|-----|------------|-------------|------------|----------------|-----|-----|-----|-----|-----|-----|-----|--------|------|------|------|------|
| | | | | | Sub address function | | | | | | | | | | | | Vcc | | | | | | | | | | |
| | | Input | SG | PIN | P49 | P51 | P52 | P57 | P58 | P59 | P60 | 00H DLA | 01H VCOA | 03H ATT | 04H DEF-EAT | P34 | P9 | P15 | P16 | P21 | P22 | P23 | Min. | Typ. | Max. | | |
| AMR | AMR | 47 | SG20 | SW PIN | | | M | | | | | | | | | | | | | | | | 45 | 50 | - | dB | |
| AFSN | AF S/N | 47 | SG17 | SW PIN | | | M | | | | | | | | | | | | | | | | 49 | 58 | - | dB | |
| GEAu | EXT audio GAIN | 53 | SG22 | SW PIN | M | | | | | | | | | 40H 1 | | | | | | | | | -2.0 | 0.0 | 2.0 | dB | |

ELECTRICAL CHARACTERISTICS

chroma block (*C0 to C13:input SGS at pin41 IN)

| Symbol | Parameter | Input signal | | SW | Test conditions | | | | | | | | | | | | | | | | | | Limits | | | Unit | Note | |
|-----------|-------------------------------------|--------------|---------------------|-----------|----------------------|-----|-----|-----|-------------|---------------|-------------|-------------|------------|-----------|----------|----------|-------------|-----|----|-----|-----|-----|--------|------|------|------|-------------------|----------------------|
| | | | | | Sub address function | | | | | | | | | | | | Vcc | | | | | | | | | | | |
| | | Input | SG | PIN | P12 | P18 | P19 | P20 | 06H DLTA | 07H TV/EXT | 09H AUTO | 05H TINT | 08H HP | 0BH CO | 08H L | 0BH V | 0BH mute | P34 | P5 | P15 | P16 | P21 | P22 | P23 | Min. | | | Typ. |
| - | Default conditions of chroma | - | - | SW PIN | 1 | 1 | 1 | | | | | | | | | | | | | | | | | | | | | |
| Cn1 | Output signal amplitude 1 | 36 | SS | SW PIN | | M | | | | | | | | | | | | | | | | | | 2000 | 2800 | 3600 | mV _{P-P} | |
| Cn2 | Output signal amplitude 2 | 36 | SS | SW PIN | | | M | | | | | | | | | | | | | | | | | 1900 | 2700 | 3500 | mV _{P-P} | |
| Acc1 | Acc 1 | 36 | VS v=+6dB | SW PIN | | | M | | | | | | | | | | | | | | | | | 1 | 4 | 6 | dB | |
| Acc2 | Acc 2 | 36 | VS v=-20dB | SW PIN | | | M | | | | | | | | | | | | | | | | | -3 | 0 | 3 | dB | |
| OV | Chroma overload | 36 | VS eb=800mV | SW PIN | | | M | | | | | | | | | | | | | | | | | -1 | 2 | 5 | dB | |
| VikP | Threshold color killer on | 36 | VS v=variable | SW PIN | | | M | | | | | | | | | | | | | | | | | - | -41 | -30 | dB | |
| killP | Residual color leakage at killer on | 36 | VS v=-45dB | SW PIN | | | M | | | | | | | | | | | | | | | | | 0 | 40 | 150 | mV _{P-P} | |
| APC1 | APC Pull-in range 1 | 36 | VS f=variable | SW PIN | | | M | | | | | | | | | | | | | | | | | +300 | +800 | - | Hz | f=eb =ec |
| R/BP | Ratio of (R-Y/B-Y) | 36 | VS eb=monochroma | SW PIN | | M | M | | | | | | | | | | | | | | | | | 0.60 | 0.81 | 1.00 | - | ec= eb+ 100kHz |
| θR-Y P | Demoduration phase θR-Y | 36 | VS eb=monochroma | SW PIN | | M | M | | | | | | | | | | | | | | | | | 80 | 95 | 110 | deg | ec= eb+ 100kHz |
| CC | Residual carrier leakage | 36 | SS | SW PIN | | | M | | | | | | | | | | | | | | | | | 0 | 60 | 120 | mV _{P-P} | |
| TC1 | Tint control 1 | 36 | VS eb=monochroma | SW PIN | | | M | | | | | | 7FH 127 | | | | | | | | | | | 30 | 44 | 60 | deg | |
| TC2 | Tint control 2 | 36 | VS eb=monochroma | SW PIN | | | M | | | | | | 00H 0 | | | | | | | | | | | 30 | 46 | 60 | deg | |

M52775FP

VIF, SIF, VIDEO, CHROMA, DEFLECTION FOR NTSC

| | | | | | | | |
|-----|-------------|-------|-----|------|-----|-----|------|
| No. | Sub address | 08H | 0BH | | 13H | | |
| | function | COLOR | DR | MUTE | SER | HST | AFCG |
| Y0 | DATA | 00H | 20H | | 00H | | |
| | function | 0 | 32 | 0 | 0 | 0 | 0 |

ELECTRICAL CHARACTERISTICS

Video & RGB I/F block (* input SGS at pin42 IN. Vcc:P3, P4, P21, P22, P23=4.75V. P5, P15, P16=8.0V supply)

| Symbol | Parameter | Input signal | | SW | Test conditions | | | | | | | | | | | | | | | | | | | | | | | | Limits | | | Unit | Note |
|--------|---------------------------------------|--------------|-----|-----|----------------------|----|-----|-----|-----|-----|--------|-----|-----|-----|-----|-----|---------|-----|-----|-----|-----|-----|------|------|------|------|------|------|--------|--|--|------|------|
| | | | | | Sub address function | | | | | | | | | | | | | | | | | | | | | | | | | | | | |
| | | | | | Input | SG | PIN | P18 | P19 | P20 | P25 | P40 | P43 | P45 | P46 | 02H | 04H | 05H | 06H | | | | 0AH | 0BH | 0CH | 10H | Min. | Typ. | Max. | | | | |
| - | Default conditions of video & RGB I/F | - | - | SW | 1 | 1 | 1 | | | | | 00H | 20H | 40H | 02H | | | | 40H | 20H | 20H | 60H | | | | | | | | | | | |
| | | | | PIN | | | | | | | 0 | 0 | 0 | 32 | 0 | 64 | 2 | 0 | 1 | 0 | 0 | 64 | 32 | 0 | 32 | 96 | | | | | | | |
| Ymax | Maximum video amplitude | 34 | SGA | SW | | | | | | | | | | 7FH | | | | | | | | | 2.5 | 3.5 | 4.5 | Vp-P | | | | | | | |
| | | | | PIN | M | M | M | | | | | | | 127 | | | | | | | | | | | | | | | | | | | |
| GY | Video gain | 34 | SGA | SW | | | | | | | | | | | | | | | | | | | 5 | 8 | 11 | dB | | | | | | | |
| | | | | PIN | M | M | M | | | | | | | | | | | | | | | | | | | | | | | | | | |
| FBY | Video frequency characteristics | 34 | SGB | SW | | | | | | | | | | | | | | | | | | | -1 | 2 | 5 | dB | | | | | | | |
| | | | | PIN | | | M | | | | | | | | | | | | | | | | | | | | | | | | | | |
| 2AGY | Double amplifier standard output | 34 | SGA | SW | | | | | | M | | | | | | | | | | | | 20H | 1.6 | 2.1 | 2.6 | Vp-P | | | | | | | |
| | | | | PIN | | | | | | | | | | | | | | | | | | 32 | 0 | | | | | | | | | | |
| CTR1 | Chroma trap attenuation 1 | 34 | SGF | SW | | | | | | | 00/20H | | | | | | | | | | | 20H | | | | | | | | | | | |
| | | | | PIN | M | M | M | | | | | 0/1 | | | | | | | | | | 32 | 0 | | | | | | | | | | |
| TRF1 | Chroma trap fine adj. attenuation 1 | 34 | SGF | SW | | | | | | | 20/30H | | | | | | | | | | | 20H | | | -18 | dB | | | | | | | |
| | | | | PIN | M | M | M | | | | | 0/1 | 1 | | | | | | | | | 32 | 0 | 0/1 | | | | | | | | | |
| YSW | Y SW OUT standard output | 34 | SGB | SW | | | | | | M | | | | | | | | | | | | | 0.51 | 0.71 | 0.91 | Vp-P | | | | | | | |
| | | | | PIN | | | | | | | | | | | | | | | | | | | | | | | | | | | | | |
| YSmax | Y SW OUT maximum output | 34 | SGB | SW | | | | | | M | | | | | | | | | | | | | 1.0 | 1.4 | 1.8 | Vp-P | | | | | | | |
| | | | | PIN | | | | | | | | | | | | | | | | | | | | | | | | | | | | | |
| E→T CT | EXT→TV crosstalk | 36 | SGB | SW | | | | | | | | | | | | | 0EH/0AH | | | | | | | - | -50 | -40 | dB | | | | | | |
| | | | | PIN | | | | | | M | | | | | | | 1/0 | | | | | | | | | | | | | | | | |
| T→E CT | TV→EXT crosstalk | 34 | SGB | SW | | | | | | | | | | | | | 0AH/0EH | | | | | | | - | -45 | -35 | dB | | | | | | |
| | | | | PIN | | | | | | M | | | | | | | 0/1 | | | | | | | | | | | | | | | | |
| YDL1 | Y delay time 1 | 34 | SGA | SW | | | | | | | | | | | | | 08H | | | | | | 200 | 280 | 360 | nsec | | | | | | | |
| | | | | PIN | M | M | M | | | | | | | | | | 0 | | | | | | | | | | | | | | | | |
| YDL2 | Y delay time 2 | 34 | SGA | SW | | | | | | | | | | | | | 09H | | | | | | 150 | 200 | 250 | nsec | | | | | | | |
| | | | | PIN | M | M | M | | | | | | | | | | 1 | | | | | | | | | | | | | | | | |
| YDL3 | Y delay time 3 | 34 | SGA | SW | | | | | | | | | | | | | | | | | | | 210 | 300 | 390 | nsec | | | | | | | |
| | | | | PIN | M | M | M | | | | | | | | | | | | | | | | | | | | | | | | | | |
| GTnor | Video tone 1 | 34 | SGB | SW | | | | | | | | | | | | | | | | | | | 1.5 | 2.1 | 2.7 | Vp-P | | | | | | | |
| | | | | PIN | M | M | M | | | | | | | | | | | | | | | | | | | | | | | | | | |
| GTmax | Video tone 2 | 34 | SGB | SW | | | | | | | | | | | | | 3FH | | | | | | | -1.3 | 2.2 | 5.7 | dB | | | | | | |
| | | | | PIN | M | M | M | | | | | | | | | | 63 | 0 | | | | | | | | | | | | | | | |
| GTmin | Video tone 3 | 34 | SGB | SW | | | | | | | | | | | | | 00H | | | | | | | -12 | -8 | -4 | dB | | | | | | |
| | | | | PIN | M | M | M | | | | | | | | | | 0 | 0 | | | | | | | | | | | | | | | |
| GT2M | Video tone 4 | 34 | SGB | SW | | | | | | | | | | | | | | | | | | | | -1.8 | 1.2 | 4.2 | dB | | | | | | |
| | | | | PIN | M | M | M | | | | | | | | | | | | | | | | | | | | | | | | | | |
| GT5M | Video tone 5 | 34 | SGB | SW | | | | | | | | | | | | | | | | | | | | -7 | -3.5 | 0 | dB | | | | | | |
| | | | | PIN | M | M | M | | | | | | | | | | | | | | | | | | | | | | | | | | |

VIF, SIF, VIDEO, CHROMA, DEFLECTION FOR NTSC

ELECTRICAL CHARACTERISTICS

Video & RGB I/F block (cont.)

| Symbol | Parameter | Input signal | | SW | Test conditions | | | | | | | | | | | | | | | | | | | | Limits | | | Unit | Note |
|--------|-----------------------------------|----------------|----------------|-------|----------------------|-------|-------|--------|-----|-------|-------|--------|------|-----|-----|-----|---------|-----|--|------|------|-------|-----|-----|--------|------|------|-------------------|-----------------------------------|
| | | | | | Sub address function | | | | | | | | | | | | | | | Min. | Typ. | Max. | | | | | | | |
| | | Input | SG | PIN | P12 | S16 | S45 | P18 | P19 | P20 | P25 | P40 | P43 | P45 | P46 | 02H | 05H | 06H | | | | | 08H | 0AH | 0DH | 0EH | 0FH | | |
| | | | DF/A | TR/F2 | TR/AP | CO/NT | DL/TA | TV/EXT | Y/C | Bl/ck | HA/DJ | CO/LOR | BR/1 | CR | CG | CB | | | | | | | | | | | | | |
| Ccon1 | Color control 1 | 36 | SGE | SW | | | | | | | | | | | | | 02H | | | 7FH | 48H | | | | 1.0 | 1.6 | 2.2 | mV _{P-P} | |
| | | | | PIN | M | | | | | | | | | | | | | | | | | 127 | 72 | | | | | | |
| Ccon2 | Color control 2 | 36 | SGE | SW | | | | | | | | | | | | | 02H | | | 7FH | 48H | | | | - | 30 | 100 | mV _{P-P} | |
| | | | | PIN | M | | | | | | | | | | | | | | | | | 127 | 72 | | | | | | |
| VMF | Video mute | 34 | SGB f=3.58M | SW | | | | | | | | | | | | | | | | | | | | | - | -45 | -35 | dB | 0BH 00/ 40H MUTE :0/1 |
| | | | | PIN | M | M | M | | | | | | | | | | | | | | | | | | | | | | |
| MTXB | Matrix 1 | 36 | VS | SW | | | | | | | | | | | | | 02H | | | 40H | 64H | | | | 1.8 | 2.6 | 3.4 | V _{P-P} | |
| | | | | PIN | M | | | | | | | | | | | | | | | | | 64 | 100 | | | | | | |
| MTXG | Matrix 2 | 36 | VS | SW | | | | | | | | | | | | | 02H | | | 40H | 64H | | | | 0.7 | 1.0 | 1.3 | V _{P-P} | |
| | | | | PIN | M | | | | | | | | | | | | | | | | | 64 | 100 | | | | | | |
| MTXR | Matrix 3 | 36 | VS | SW | | | | | | | | | | | | | 02H | | | 40H | 64H | | | | 1.4 | 2.0 | 2.6 | V _{P-P} | |
| | | | | PIN | | M | | | | | | | | | | | | | | | | 64 | 100 | | | | | | |
| OSD1 | OSD speed 1 | 24.26 28.30 | SGD | SW | | | | | | | | | | | | | | | | | | | | | - | 20 | 100 | nsec | |
| | | | | PIN | M | M | M | | | | | | | | | | | | | | | | | | | | | | |
| OSD2 | OSD speed 2 | 24.26 28.30 | SGD | SW | | | | | | | | | | | | | | | | | | | | | - | 50 | 130 | nsec | |
| | | | | PIN | M | M | M | | | | | | | | | | | | | | | | | | | | | | |
| GYmax1 | Contrast 3 | 34 | SGA | SW | | | | | | | | | | | | | 7FH | | | | | | | | 2.0 | 2.8 | 3.6 | V _{P-P} | |
| | | | | PIN | M | M | M | 2.9V | | | | | | | | | | | | | | 127 | | | | | | | |
| GYmin1 | Contrast 4 | 34 | SGA | SW | | | | | | | | | | | | | 7FH | | | | | | | | - | 20 | 100 | mV _{P-P} | |
| | | | | PIN | M | M | M | 0V | | | | | | | | | | | | | | 127 | | | | | | | |
| BLS1 | Black expansion characteristics 1 | 34 | SGC | SW | | | | | | | | | | | | | 0AH/1AH | | | | | | | | 100 | 250 | 850 | mV _{P-P} | |
| | | | | PIN | M | | | | | | | | | | | | | | | | | 0/1 | | | | | | | |
| BLS2 | Black expansion characteristics 2 | 34 | SGC | SW | | | | | | | | | | | | | 0AH/1AH | | | | | | | | -100 | 50 | 200 | mV _{P-P} | |
| | | | | PIN | M | | | | | | | | | | | | | | | | | 0/1 | | | | | | | |
| BLS3 | Black expansion characteristics 3 | 34 | SGC | SW | | | | | | | | | | | | | 0AH/1AH | | | | | | | | -100 | 0 | 100 | mV _{P-P} | |
| | | | | PIN | M | | | | | | | | | | | | | | | | | 0/1 | | | | | | | |
| ABL1 | ABL characteristics 1 | - | - | SW | | | | | | | | | | | | | | | | | | | | | 3.35 | 3.75 | 4.15 | V | |
| | | | | PIN | M | | | | | | | | | | | | | | | | | 4.75V | | | | | | | |
| ABL2 | ABL characteristics 2 | - | - | SW | | | | | | | | | | | | | | | | | | | | | 1.05 | 1.55 | 2.05 | V | |
| | | | | PIN | M | | | | | | | | | | | | | | | | | 0V | | | | | | | |
| γ1 | Gamma characteristics 1 | 34 | SGA | SW | | | | | | | | | | | | | 7FH | | | | | | | | 2.6 | 3.5 | 4.4 | V _{P-P} | |
| | | | | PIN | M | | | | | | | | | | | | | | | | | 127 | | | | | | | |
| γ2 | Gamma characteristics 2 | 34 | SGA | SW | | | | | | | | | | | | | 7FH | | | | | | | | 2.0 | 2.7 | 3.4 | V _{P-P} | |
| | | | | PIN | M | | | | | | | | | | | | | | | | | 127 | | | | | | | |

ELECTRICAL CHARACTERISTICS TEST METHOD

P/N Video S/N

1. Input SG3 and measure the rms value of output signal at pin 57.
2. P/N is defined as follows:

$$P/N=20\log \frac{V_{0NEG} \text{ measured value (VP-P)} \times 10^3 \times 0.7}{\text{Measured value (mVrms)}} \text{ (dB)}$$

Vf Video frequency characteristics

1. Input SG4 and set the frequency f2 to 44.75MHz so that the beat element of 1MHz is output to pin 57.
2. Then set the applied voltage at pin 60 so that the beat element of 1MHz at pin 57 may be 100dBμ.
3. Decrease f2 to the level at which the beat element becomes 3dB smaller than the element of 1MHz, and read the value at that level.

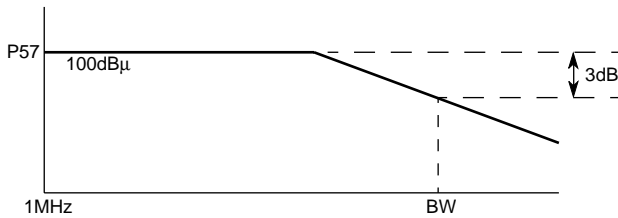

Vin min. Input sensitivity

1. Decrease SG5 level until the video detector output is 3dB smaller than the measured value of Parameter V3 "Video detector output".

Vin max. Maximum permissible input

1. Input 90dBμ SG6.
2. VA is the output level at pin 57. Increase SG6 voltage until the output at pin 57 becomes 3dB smaller than VA. The input level at that time is the maximum permissible input.

μAFTN AFT detector sensitivity

V58H Maximum AFT voltage, V58L Minimum AFT voltage

See the following figure.

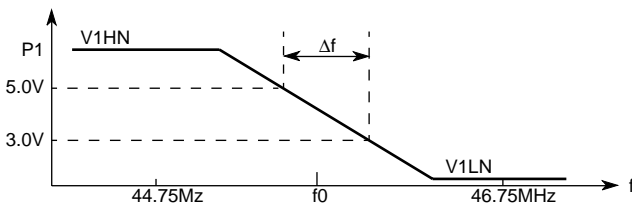

μAFTN is defined as follows:

$$\mu\text{AFTN} = \frac{(5.0-3.0) \times 10^3 \text{mV}}{\Delta f \text{ kHz}} \text{ (mV/kHz)}$$

IM Intermodulation

1. Adjust the applied voltage at pin 60 so that the lowest output signal voltage at pin 57 is 2.2V.



2. Measure elements of 0.92MHz and 3.579545MHz of output at pin 57.
3. IM is defined as follows:

$$IM=20\log \frac{\text{Element of 0.92MHz}}{\text{Element of 3.579545MHz}} \text{ (dB)}$$

ATT Maximum attenuation

1. Measure the element of 400Hz of output at pin 51.

$$ATT=20\log \frac{V_{0AFmax}}{\text{Measured value}} \text{ (dB)}$$

LIM Input limiting sensitivity

Decrease the input level of SG18. Measure the input level when the element of 400Hz at pin 52 is 3dB smaller than V0AFM (S6: Maximum AF output (6.0M)).

AMR

1. Vam is the element of 400Hz at pin 52.
2. AMR is defined as follows:

$$AMR=20\log \frac{V_{0AF} \text{ (mVrms)}}{V_{am} \text{ (mVrms)}} \text{ (dB)}$$

AF S/N

1. Measure the noise (20Hz to 100kHz) of output at pin 52.
2. AF S/N is defined as follows:

$$AF \text{ S/N}=20\log \frac{V_{0AFmax}}{\text{Measured value}} \text{ (dB)}$$

GEAu EXT Audio GAIN

Input SG22 at pin 53, and measure the output VP-P at pin 49.

$$GAIN=20\log \frac{\text{Input signal VP-P}}{\text{Output signal VP-P (pin49)}} \text{ (dB)}$$

Cn1 Output signal amplitude 1

Cn2 Output signal amplitude 2

1. Input SS from pin 36 IN.
2. Measure output amplitude, Cn1 and Cn2, at pins 18 and 20 respectively.

VIF, SIF, VIDEO, CHROMA, DEFLECTION FOR NTSC

Acc1

1. Input VS (eb=570mV:level+6dB) from pin 36 IN.
2. Measure the output amplitude at pin 20.
3. Acc1 is defined as follows:

$$Acc1 = 20 \log \frac{\text{Measured value (V}_{P-P})}{Cn1 (V_{P-P})} \text{ (dB)}$$

Acc2

1. Input VS (input level:-20dB) from pin 36 IN.
2. Measure the output amplitude at pin 20.
3. Acc2 is defined as follows:

$$Acc2 = 20 \log \frac{\text{Measured value (V}_{P-P})}{Cn1 (V_{P-P})} \text{ (dB)}$$

OV Chroma overload

1. Input VS (ec=800mV:P-P:chroma+3dB) from pin 36 IN.
2. Measure the output amplitude at pin 20.
3. OL is defined as follows:

$$OL = 20 \log \frac{\text{Measured value (V}_{P-P})}{Cn1 (V_{P-P})} \text{ (dB)}$$

VikP Threshold color killer on

1. Input VS (level:variable) from pin 36 IN at input level 0dB.
2. Lower the input level whth monitoring the output amplitude at pin 20 and measure the input level when output amplitude isnot found.

KillIP Residual color leakage at killer on

1. Input VS (level:-45dB) from pin 36 IN.
2. Measure the output amplitude at pin 20.

APC1 APC pull-in range 1

1. Input VS (f=eb=ec=variable) from pin 36 IN.
2. Change the input signal frequency and measure the frequency range from the point at which signal is output to pin 20 and to the point that no signal is output to the pin. The reference value is 3.579545MHz.

R/B P Ratio of (R-Y/B-Y)

1. Input VS (eb=single chroma=ec+100kHz) from pin 36 IN.
2. V20 is the output amplitude at pin 20.
3. V18 is the output amplitude at pin 18.
4. R/B P is defined as follows:

$$R/B P = 20 \log \frac{V18 (V_{P-P})}{V20 (V_{P-P})} \text{ (dB)}$$

θR-Y P Demodulation phase

1. Input VS (ed=single chroma=ec+100kHz) from pin 36 IN.
2. V20 is the output amplitude at pin 20.
3. V18 is the output amplitude at pin 18.
4. R-Y P is defined as follows:

$$\theta_{R-Y P} = \tan^{-1} \frac{V18 \times 3.8}{(V20 \times 1.9) + 45^\circ} \text{ (deg)}$$

CC Residual carrier leakage

Measure the element of 3.58MHz of the demodulated output in no-input state.

TC1 Tint control 1, TC2 Tint control 2

1. Input VS (see the following figure) from pin 36 IN. Based on the output voltage at pin 20, find the absolute angle as shown in the following figure.

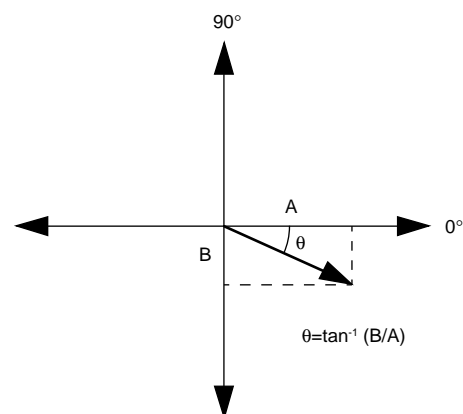
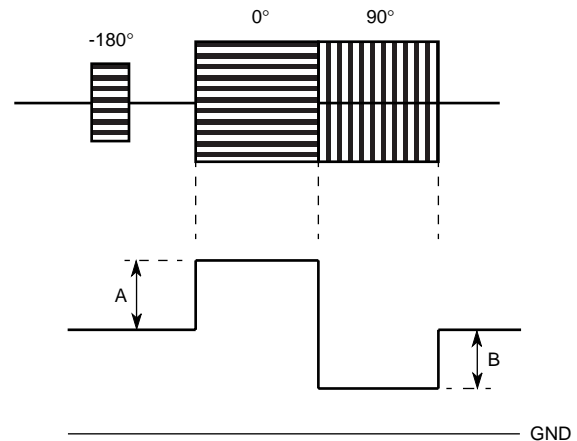

VIF, SIF, VIDEO, CHROMA, DEFLECTION FOR NTSC

Ymax Maximum video output

1. Input SGA into pin 34 IN and input SGS from pin 42 IN.
2. Measure the amplitude (P-P) except that at blanking part of output at pins 18, 19 and 20.



GY Video gain

1. Input SGA into pin 34 IN and input SGS from pin 42 IN.
2. Measure the amplitude (P-P) except that at blanking part of output at pins 18, 19 and 20. This amplitude is defined as G1.

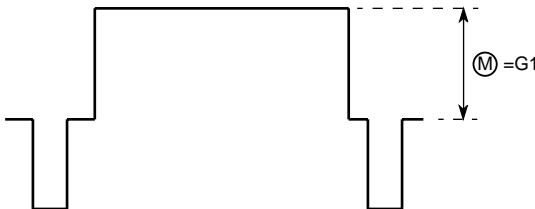

3. GY is defined as follows:

$$GY = 20 \log (G1VP-P / 0.714VP-P) \text{ (dB)}$$

BW Video frequency characteristics

1. Input SGB (5MHz, 0.4VP-P) into pin 34 IN and input SGS from pin 42 IN.
2. Measure the amplitude (P-P) except that at blanking part of the output at pin 19. The amplitude is defined as YB.
3. BW is defined as follow:

$$BW = 20 \log (YB VP-P / GY VP-P) \text{ (dB)}$$

2AGY Double amplifier standard output

1. Input SGA into pin 34 IN and input SGS from pin 42 IN.
2. Measure the amplitude (P-P) at pin 40 output.

CTR1 Chroma trap attenuation 1 (common to R/G/B output)

1. Input SS from pin 41 IN and input SGS into pin 42 IN. Measure the frequency level of 3.58MHz at trap data 0. The level is defined as No.
2. Then, measure the level at trap data 1.
3. CTR1 is defined as follows.

$$CTR1 = 20 \log \frac{\text{Measured value (mVP-P)}}{N_0 \text{ (mVP-P)}} \text{ (dB)}$$

TRF1 Chroma trap fine adj. attenuation 1 (common to R/G/B output)

1. Input SS from pin 34 IN and input SGS from pin 42 IN.
2. Measure the output amplitude of the element of 3.58MHz when trap fine adj. switch is on. (TRFon)

3. TRF1 is defined as follows.

$$TRF1 = 20 \log \frac{TRFon \text{ (mVP-P)}}{N_0 \text{ (mVP-P)}} \text{ (dB)}$$

4. Measure the most attenuation part in three condition of (2), and the most attenuation part is defined as Y6.

The three condition of (2) is shown below.

| | TRAP FINE ADT SW | FINE 2 |
|-------------|------------------|--------|
| condition 1 | ON | OFF |
| condition 2 | OFF | ON |
| condition 3 | ON | ON |

YSWY SW OUT standard output

1. Input SGB from pin 34 IN and input SGS into pin 42 IN.
2. Measure the output amplitude of the pin 43 output video block.

YSmax Y SW OUT standard output

1. Input SGB (video amplitude 1.5VP-P) from pin 34 IN and input SGS into pin 42 IN.
2. Measure the output amplitude of the pin 43 output video block.

E→T CT EXT→TV crosstalk

1. Input SGB (f=5MHz) from pin 36 IN and input SGS into pin 42 IN.
2. Specify pin 43 output for EXT to be VEXT.
3. Specify pin 43 output for TV to be VTV.
4. E→T CT is defined as follows.

$$E \rightarrow T \text{ CT} = 20 \log \frac{VTV \text{ (mVP-P)}}{VEXT \text{ (mVP-P)}} \text{ (dB)}$$

T→E CT TV→EXT crosstalk

1. Input SGB (f=5MHz) from pin 41 IN and input SGS into pin 42 IN.
2. Specify pin 43 output for TV to be VTV.
3. Specify pin 43 output for EXT to be VEXT.
4. T→E CT is defined as follows.

$$T \rightarrow E \text{ CT} = 20 \log \frac{VEXT \text{ (mVP-P)}}{VTV \text{ (mVP-P)}} \text{ (dB)}$$

YDL1 Y delay time1

1. Input SGA from pin 34 IN and input SGS into pin 42 IN.
2. Measure the delay time from signal input to output at pins 18, 19 and 20.

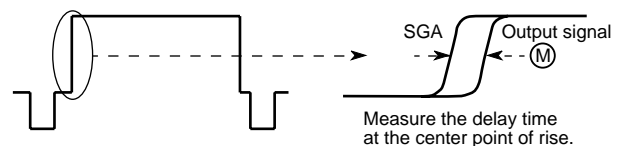

YDL2 to 3 Y delay time2 to 3

1. Input SGA from pin 34 IN and input SGS into pin 42 IN.
2. Measure the delay time from signal output at pins 18, 19 and 20 to Y11, YDL1.

VIF, SIF, VIDEO, CHROMA, DEFLECTION FOR NTSC

GTnor Video tone 1

1. Input SGB (f=3MHz) from pin 34 IN and input SGS into pin 42 IN.
2. Measure output amplitude at pins 18, 19 and 20.

GTmax Video tone 2

1. Input SGB (f=3MHz) from pin 34 IN and input SGS into pin 42 IN.
2. Measure output amplitude at pins 18, 19 and 20.
3. GTmax is defined as follows:

$$GTmax=20\log \frac{\text{Measured value (VP-P)}}{GTnor (VP-P)} \text{ (dB)}$$

GTmin Video tone 3

1. Input SGB (f=3MHz) from pin 34 IN and input SGS into pin 42 IN.
2. Measure output amplitude at pins 18, 19 and 20.
3. GTmin is defined as follows:

$$GTmin=20\log \frac{\text{Measured value (VP-P)}}{GTnor (VP-P)} \text{ (dB)}$$

GT2M Video tone 4

1. Input SGB (f=2MHz) from pin 34 IN and input SGS into pin 42 IN.
2. Measure output amplitude at pins 18, 19 and 20.
3. GT2M is defined as follows:

$$GT2M=20\log \frac{\text{Measured value (VP-P)}}{GTnor (VP-P)} \text{ (dB)}$$

GT5M Video tone 5

1. Input SGB (f=5MHz) from pin 34 IN and input SGS into pin 42 IN.
2. Measure output amplitude at pins 18, 19 and 20.
3. GT5M is defined as follows:

$$GT5M=20\log \frac{\text{Measured value (VP-P)}}{GTnor (VP-P)} \text{ (dB)}$$

GYnor Contrast 1

1. Input SGB (f=100kHz) from pin 34 IN and input SGS into pin 42 IN.
2. Measure output amplitude at pins 18, 19 and 20.

GYmin Contrast 2

1. Input SGB (f=100kHz) from pin 34 IN and input SGS into pin 42 IN.
2. Measure output amplitude at pins 18, 19 and 20.
3. GYmin is defined as follows:

$$GYmin=20\log \frac{\text{Measured value (VP-P)}}{GYnor (VP-P)} \text{ (dB)}$$

Lum nor Brightness control 1, Lum max Brightness control 2,

Lum min Brightness control 3

1. No signal is input. (Only SGS is input to pin 42 IN.)

2. Measure DC voltage of output at pins 18, 19 and 20 except that at blanking part.

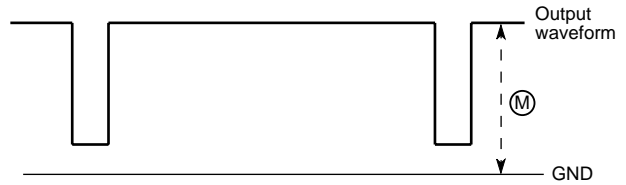

3. Y22=(Lum max)-(Lum nor), Y23=(Lum min)-(Lum nor)

D (R) Drive R

1. Input SGA from pin 34 IN and input SGS into pin 42 IN.
2. Measure DRmin and DRmax which are output amplitude at pins 18 at D (R) data min and D (R) data max respectively.
3. D (R) is defined as follows:

$$D (R)=20\log \frac{DRmax (VP-P)}{DRmin (VP-P)} \text{ (dB)}$$

D (B) Drive B

1. Input SGA from pin 34 IN and input SGS into pin 42 IN.
2. Measure DBmin and DBmax which are output amplitude at pin 20 at D (B) data min and D (B) data max respectively.
3. D (B) is defined as follows:

$$D (B)=20\log \frac{DBmax (VP-P)}{DBmin (VP-P)} \text{ (dB)}$$

EX (R) EXT (R) I/O, EX (G) EXT (G) I/O, EX (B) EXT (B) I/O

1. Input SGD into each of pin 30, 24, 26 and 28 and input SGS into pin 42 IN.
2. Measure output amplitude which is higher than the pedestal level at pins 18, 19 and 20. The amplitude at blanking part should not be measured.

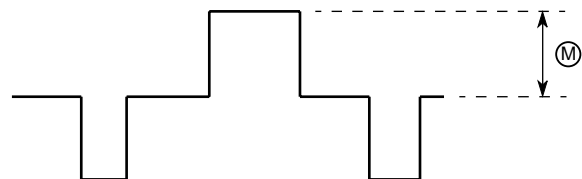

OFRG Offset voltage R-G, OFBG Offset voltage B-G

1. Measure DC voltage of output at pin 18, 19 and 20 except that at blanking part .
2. OFRG and OFBG are defines as follows:

OFRG=

(pin 18 Measured voltage)-(pin 19 Measured voltage) (mV)

OFBG=

(pin 20 Measured voltage)-(pin 19 Measured voltage) (mV)

VIF, SIF, VIDEO, CHROMA, DEFLECTION FOR NTSC

R (C) Cutoff R, G (C) Cutoff G, B (C) Cutoff B

1. Measure DC voltage of output at pin 18, 19 and 20 when R (C), G (C) and B (C) data are maximum and minimum respectively. The DC voltage at blanking part should not be measured.
2. R (C), G (C) and B (C) are defined as follows:
R (C), G (C) and B (C)=
(Voltage at data max.)-(Voltage at data min.) (V)

DLFY delay time (fine)

1. Input SGA from pin 34 IN and input SGS into pin 42 IN.
2. Measure the time lag (absolute value) between signal YDL3 and output signal at pins 18, 19 and 20.

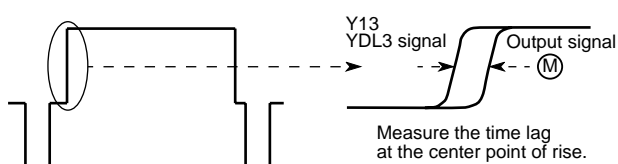

Ccon1 Color control 1, Ccon2 Color control 2

1. Input VS (ec=eb+100kHz) from pin 36 and input SGS into pin 42 IN.
2. Measure output amplitude at pins 18, 19 and 20 under each condition.

VMF Video mute

1. Input SGF from pin 34 and input SGS into pin 42 IN.
2. Measure output amplitude of the element of 3.58MHz when the mute switch is on and off. (VMFon, VMFoff)
3. VMF is defined as follows:

$$VMF=20\log \frac{VMFon (VP-P)}{VMFoff (VP-P)} \text{ (dB)}$$

MTXB Matrix 1, MTXG Matrix 2

1. Input VS (ec=eb+100kHz) from pin 36 and input SGS into pin 42 IN.
2. Measure output amplitude at pins 20 and 19.
(P20=MTXB, P19=MTXG)

MTXR Matrix 3

1. Input VS (ec=eb+100kHz) from pin 36 and input SGS into pin 42 IN.
2. Measure output amplitude at pin 18.
(P18=MTXR)

OSD1 OSD speed 1, OSD2 OSD speed 2

1. Input SGD into each of pin 30, 24, 26 and 28 and input SGS into pin 42 IN.

2. Measure rise time and fall time of the signal of output at pins 18, 19 and 20. Measurement points should be higher than the pedestal level and blanking part should not be measured.

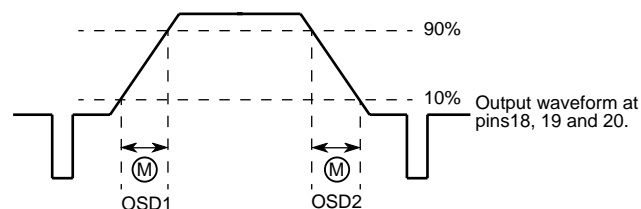

GYmax1 Contrast 3, GYmin1 Contrast 4

1. Input SGA from pin 34 IN and input SGS into pin 42 IN.
2. Measure output amplitude at pins 18, 19 and 20 when 2.9V and 0V are externally applied to pin 25.

ABR Bright increase voltage

1. Non-input.
2. Measure the voltage except for pin 19 blanking.

BLS1 Black expansion characteristics 1,

BLS2 Black expansion characteristics 2,

BLS3 Black expansion characteristics 3

1. Input SGC (BLS1=0.2VP-P, BLS2=0.45VP-P, BLS3=0VP-P) from pin 34 IN and input SGS into pin 42 IN.
2. With black expansion set to ON/OFF, specify the pin 19 output voltages to be VBLSON1 to 3/BVLSOFF1 to 3, respectively.
3. The standard shall be expressed by BLS1 to 3=VBLSOFF1 to 3-BVLSON1 to 3 (mVP-P).

ABL1 ABL characteristics 1, ABL2 ABL characteristics 2

1. Non-input.
2. When a voltage of 4.75V is applied to pin 46, measure the output voltage at pin 19 and specify the value to be ABL1.
3. When a voltage of 0V is applied to pin 46, measure the output voltage at pin 19 and specify the value to be ABL2.

γ1 Gamma characteristics 1, γ2 Gamma characteristics 2

1. Input SGA from pin 34 IN and input SGS into pin 42 IN.
2. When a voltage of 4.75V is applied to pin 45, measure the amplitude of pin 19 output and specify the value to be γ1.
3. When a voltage of 0V is applied to pin 45, measure the amplitude of pin 19 output and specify the value to be γ2.
4. γ1, γ2 are defined as follows:
γ2=γ1-Measured value (mVP-P)

ISS Sync separation input sensitivity current

When current flows from pin 42, measure the flow current with the burst gate pulse of P8SCP eliminated.

VIF, SIF, VIDEO, CHROMA, DEFLECTION FOR NTSC

BGP1 Burst gate pulse timing 1

BGP2 Burst gate pulse timing 2, BGPW Burst gate pulse width

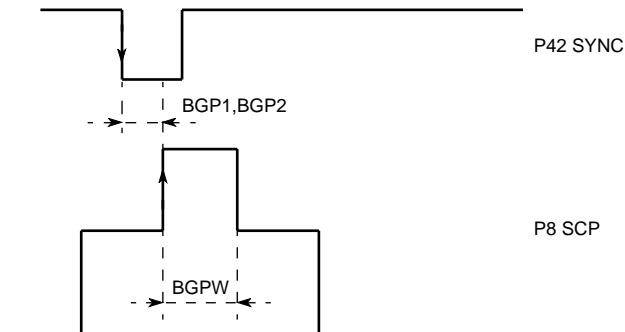

FH Horizontal free running frequency

Measure the output frequency at pin 10 when no signal is input .

FPH1 Horizontal pull-in range 1

FPH2 Horizontal pull-in range 2

Change the frequency of SGc and measure the frequency at the moment when the output signal at pin 10 and the input signal at pin 42 are pulled in. The horizontal pull-in range is measured by comparing with 15.734kHz.

HPT1 Horizontal pulse timing 1

HPT2 Horizontal pulse timing 2

HPT3 Horizontal pulse timing 3

$$\begin{aligned} \text{HPT2} &= \text{Hphase data (0) - HPT1} \\ \text{HPT3} &= \text{Hphase data (15) - HPT1} \end{aligned}$$

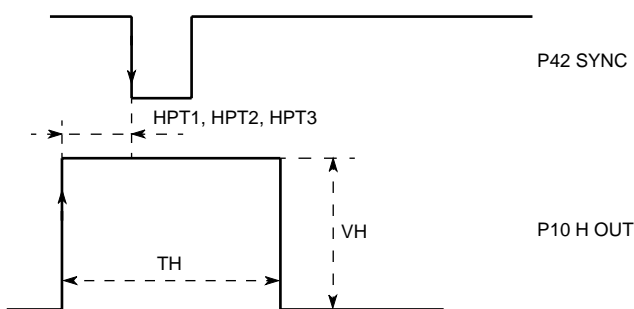

TH Horizontal pulse width, VH Horizontal pulse amplitude

HSTO Horizontal pulse stop function

Confirm that the horizontal output is high when the horizontal stop switch is on.

AFCG AFC gain

1. Measure AFC on which is the output amplitude of pin 12 when AFC switch is on and AFC off which is that when the switch is off.
2. AFCG is defined as follows:

$$\text{AFCG} = 20 \log \frac{\text{AFC}_{\text{on}} (\text{V}_{\text{P-P}})}{\text{AFC}_{\text{off}} (\text{V}_{\text{P-P}})} \text{ (dB)}$$

FV Vertical free running frequency

Measure the output frequency at pin 14 when no signal is input.

SW Service SW operation

Measure the output DC voltage at pin 14 when the service switch is on.

FPV Vertical pull-in range

Decrease the frequency of SGd and measure the frequency when output waveform at pin 14 is pulled in.

VW Vertical pulse width (free running)

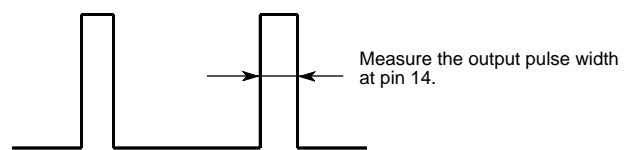

VBLKW Vertical blanking width

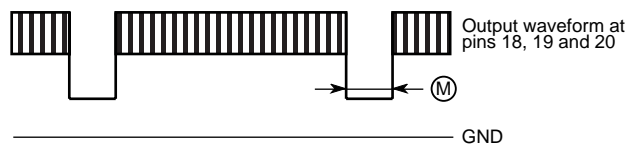

WVSS Vertical sync.detection minimum width

Change the input pulse width of SGd and measure the input pulse width at the moment when the output signal at pin 14 is pulled in.

FBPI FBP inv OUT

Measure the Hi and Lo voltages of the pin 13 output pulse.

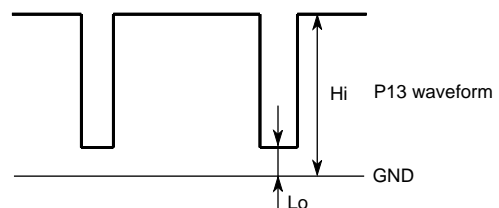

VIF, SIF, VIDEO, CHROMA, DEFLECTION FOR NTSC

Note: The timing and pulse width of the horizontal blanking pulse should be as shown in the following figure by adjusting the variable resistor of the single shot multi vibrator.

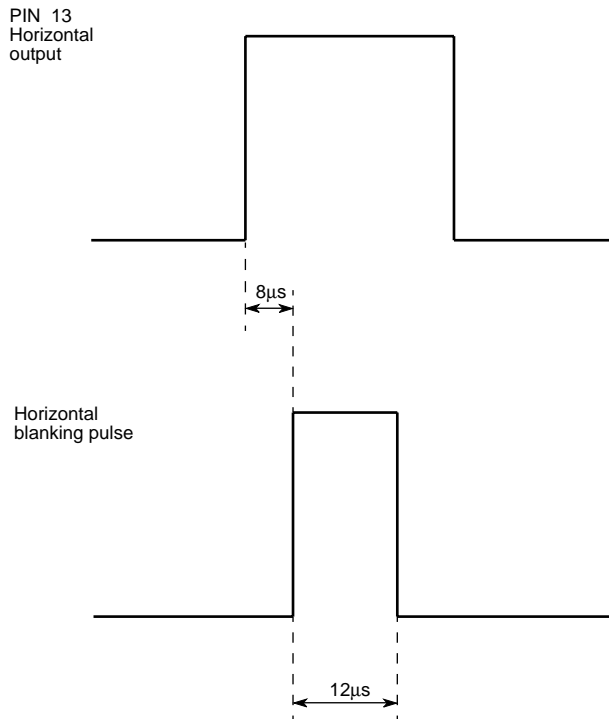

The variable resistor at pin 15 of the TTL IC, M74LS221P, is used to fix the timing at $8\mu\text{s}$ and that at pin 7 is used to fix the pulse width at $12\mu\text{s}$.

*Coil adjustment

VCO COIL

1. Input CW ($f_0=45.75\text{MHz}$, $V_i=90\text{dB}\mu$) to input pin A.
2. Set the DC voltage at pin 58 (AFT OUT) to $1/2V_{cc}$ (4.0V) by adjusting VCO coil.

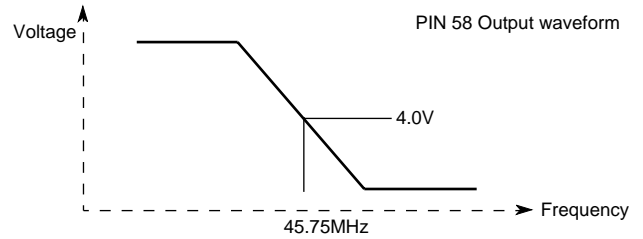

Note: VCO coil should always be adjusted as above before using this IC.

M52775FP

VIF, SIF, VIDEO, CHROMA, DEFLECTION FOR NTSC

I²C BUS FORMATS

(1) Slave address: A6 A5 A4 A3 A2 A1 A0 R/W
 1 0 1 1 1 0 1 0 (=BAH)

(2) Slave address format:

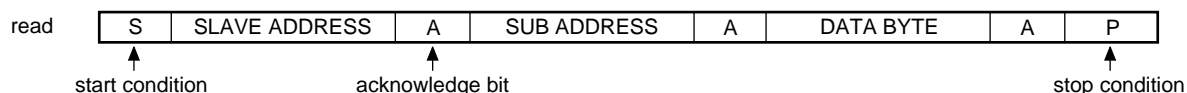

(3) Sub address byte and data byte format:

read

| | No. | Functions | BIT | SUB ADD | Data byte | | | | | | | |
|-------------|-----|---------------|-----|---------|-----------|----------|----------|--------|------------|----------|--------|------|
| | | | | | D7 | D6 | D5 | D4 | D3 | D2 | D1 | D0 |
| VIF/SIF | 1 | DELAY ADJ | 6 | 00H | 0 | – | A05 | A04 | A03 | A02 | A01 | A00 |
| | 4 | AUDIO SW | 1 | 01H | | AUDIO SW | | | | | | |
| | 6 | DEFEAT | 1 | 04H | | DEFEAT | | | | | | |
| | 7 | AUDIO ATT | 7 | 03H | 0 | A36 | A35 | A34 | A33 | A32 | A31 | A30 |
| VIDEO | 8 | VIDEO TONE | 6 | 04H | 0 | – | A45 | A44 | A43 | A42 | A41 | A40 |
| | 9 | CONTRAST | 7 | 05H | 0 | A56 | A55 | A54 | A53 | A52 | A51 | A50 |
| | 10 | DL time ADJ | 2 | 06H | 0 | – | 0 | – | – | – | A61 | A60 |
| | 25 | DL fine ADJ. | 1 | 02H | | | | | | | DLfine | |
| | 11 | TV/EXT SW | 1 | 06H | | | | | | TV/EXT | | |
| | 12 | Y/C SW | 1 | 06H | | | | | Y/C IN | | | |
| | 13 | Black Stretch | 1 | 06H | | | | black | | | | |
| | 14 | TRAP SW | 1 | 02H | | | TRAP | | | | | |
| | 38 | TRAP ADJ 1 | 1 | 10H | | | TADJ1 | | | | | |
| | 40 | TRAP ADJ 2 | 1 | 02H | | | | TADJ2 | | | | |
| CHROMA | 36 | VIDEO MUTE | 1 | 0BH | | V MUTE | | | | | | |
| | 15 | TINT | 7 | 07H | 0 | A76 | A75 | A74 | A73 | A72 | A71 | A70 |
| | 16 | COLOR | 7 | 08H | 0 | A86 | A85 | A84 | A83 | A82 | A81 | A80 |
| INTER-FACE | 26 | KILLER OFF | 1 | 09H | | | | | | KILL OFF | | |
| | 19 | BRIGHT | 7 | 0AH | 0 | AA6 | AA5 | AA4 | AA3 | AA2 | AA1 | AA0 |
| | 20 | DRIVE (R) | 6 | 0BH | 0 | – | AB5 | AB4 | AB3 | AB2 | AB1 | AB0 |
| | 21 | DRIVE (B) | 6 | 0CH | 0 | 0 | AC5 | AC4 | AC3 | AC2 | AC1 | AC0 |
| | 22 | CUT OFF (R) | 8 | 0DH | AD7 | AD6 | AD5 | AD4 | AD3 | AD2 | AD1 | AD0 |
| | 23 | CUT OFF (G) | 8 | 0EH | AE7 | AE6 | AE5 | AE4 | AE3 | AE2 | AE1 | AE0 |
| | 24 | CUT OFF (B) | 8 | 0FH | AF7 | AF6 | AF5 | AF4 | AF3 | AF2 | AF1 | A100 |
| DEFLEC-TION | 27 | AFC-2 H PHASE | 4 | 09H | 0 | A96 | A95 | A94 | A93 | – | – | – |
| | 33 | SERVICE SW | 1 | 13H | | | | | Service SW | | | |
| | 34 | H STOP | 1 | 13H | | | | H STOP | | | | |
| | 35 | AFC GAIN | 1 | 13H | | | AFC GAIN | | | | | |
| | 42 | H fo ADJ | 1 | 06H | | HADJ | | | | | | |
| | 32 | 2 WINDOW SW | 1 | 12H | | | 2WS | | | | | |

VIF, SIF, VIDEO, CHROMA, DEFLECTION FOR NTSC

DATA BYTE CONDITIONS AT SW

| | Functions | Data | Condition | Initial condition | |
|------------------|------------------|------------|-----------|-------------------|-------------|
| IF | AUDIO SW | AUDIO SW | 0 | TV | TV |
| | | | 1 | EXT | |
| | DEFEAT | DEFEAT | 0 | OFF | OFF |
| | | | 1 | ON | |
| VIDEO | DL time ADJ | A61, A60 | 0 0 | 220nsec | 420nsec |
| | | | 0 1 | 320nsec | |
| | | | 1 0 | 420nsec | |
| | | | 1 1 | 420nsec | |
| | DL time fine ADJ | DL fine | 0 | +50nsec | +0nsec |
| | | | 1 | +0nsec | |
| | TV/EXT | TV/EXT | 0 | TV | TV |
| | | | 1 | EXT | |
| | Y/C IN | Y/C IN | 0 | Y/C | Y/C |
| | | | 1 | TV or EXT | |
| | black stretch | black | 0 | OFF | OFF |
| | | | 1 | ON | |
| | TRAP SW | TRAP | 0 | OFF | OFF |
| | | | 1 | ON | |
| | TRAP fine adj. 1 | TADJ1 | 0 | OFF | OFF |
| | | | 1 | ON | |
| TRAP fine adj. 2 | TADJ2 | 0 | OFF | ON | |
| | | 1 | ON | | |
| VIDEO MUTE | V MUTE | 0 | OFF | OFF | |
| | | 1 | ON | | |
| CHROMA | KILLER OFF | | 0 | Normal | Normal |
| | | | 1 | KILLER OFF | |
| | | | | | |
| DEFLECTION | Service SW | Service SW | 0 | Normal mode | Normal mode |
| | | | 1 | Service mode | |
| | H STOP | H STOP | 0 | H out | H out |
| | | | 1 | H stop | |
| | AFC GAIN | AFC GAIN | 0 | NORMAL | NORMAL |
| | | | 1 | HIGH | |
| | H fo ADJ | H ADJ | 0 | fo down | fo down |
| | | | 1 | fo up | |
| 2 WINDOW | 2 WINDOW SW | 0 | Normal | Normal | |
| | | 1 | 2 WINDOW | | |

VIF, SIF, VIDEO, CHROMA, DEFLECTION FOR NTSC

DATA BYTE CONDITIONS AT D/A

| | Functions | BIT | Data | Condition | Initial condition |
|------------|---------------|-----|----------|-----------|-------------------|
| IF | DELAY ADJ | 6 | 0 to 63 | | 32 |
| | AUDIO ATT | 7 | 0 to 127 | | 32 |
| VIDEO | VIDEO TONE | 6 | 0 to 63 | | 0 |
| | contrast cont | 7 | 0 to 127 | | 32 |
| CHROMA | tint cont | 7 | 0 to 127 | | 64 |
| | color cont | 7 | 0 to 127 | | 32 |
| INTERFACE | bright cont | 7 | 0 to 127 | | 32 |
| | drive (R) | 6 | 0 to 63 | | 32 |
| | drive (B) | 6 | 0 to 63 | | 32 |
| | cut off (R) | 8 | 0 to 255 | | 128 |
| | cut off (G) | 8 | 0 to 255 | | 128 |
| | cut off (B) | 8 | 0 to 255 | | 128 |
| DEFLECTION | AFC-2 H phase | 4 | 0 to 15 | | 10 |

I²C BUS CONTROL SECTION SDA, SCL CHARACTERISTICS

| Symbol | Parameter | Limits | | Unit |
|---------------------|---|--------|------|------|
| | | Min. | Max. | |
| V _{IL} | Min. input low voltage | -0.5 | 1.5 | V |
| V _{IH} | Max. input high voltage | 3.0 | 5.5 | V |
| f _{SCL} | SCL clock frequency | 0.0 | 100 | kHz |
| t _{BUF} | Time the bus must be free before a new transmission can start | 4.7 | – | µs |
| t _{HD:STA} | Hold time start condition. After this period the first clock pulse is generated | 4.0 | – | µs |
| t _{LOW} | The low period of the clock | 4.7 | – | µs |
| t _{HIGH} | The high period of the clock | 4.0 | – | µs |
| t _{SU:STA} | Setup time for start condition (Only relevant for a repeated start condition) | 4.7 | – | µs |
| t _{HD:DAT} | Hold time DATA | 0.0 | – | µs |
| t _{SU:DAT} | Set-up time DATA | 250 | – | ns |
| t _r | Rise time of both SDA and SCL lines | – | 1000 | ns |
| t _f | Fall time of both SDA and SCL lines | – | 300 | ns |
| t _{SU:STO} | Set-up time for stop condition | 4.0 | – | µs |

TIMING DIAGRAM

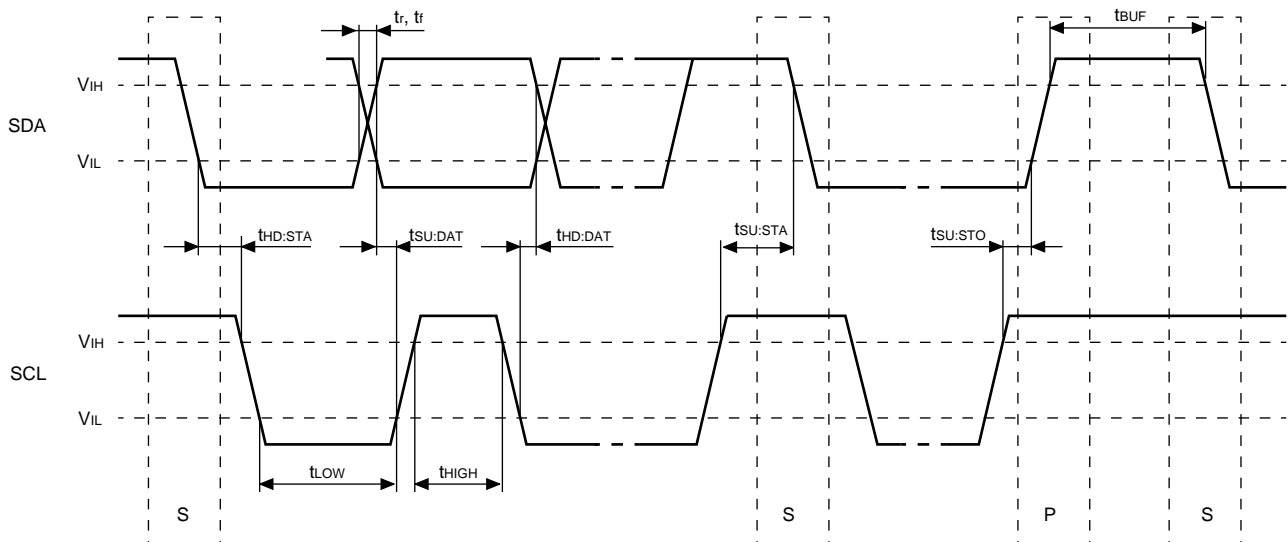

VIF, SIF, VIDEO, CHROMA, DEFLECTION FOR NTSC

**INPUT SIGNAL
VIF/SIF**

| SG No. | Signals (50Ω termination) |
|--------|--|
| 1 | f ₀ =45.75MHz 90dBμ fm=20kHz AM77.8% |
| 3 | f ₀ =45.75MHz 90dBμ CW |
| 4 | f ₁ =45.75MHz 90dBμ CW (Mixed signal) f ₂ =44±5MHz 70dBμ CW (Mixed signal) |
| 5 | f ₀ =45.75MHz variable fm=20kHz AM77.8% |
| 6 | f ₀ =45.75MHz fm=20kHz AM16% level variable |
| 7 | f ₀ =45.75MHz 80dBμ CW |
| 8 | f ₀ =45.75MHz 110dBμ CW |
| 9 | f ₀ =45.75±5MHz 90dBμ CW |
| 10 | f ₀ =44.75MHz 90dBμ CW |
| 11 | f ₀ =46.75MHz 90dBμ CW |
| 12 | f ₁ =45.75MHz 90dBμ CW (Mixed signal) f ₂ =41.25MHz 80dBμ CW (Mixed signal) f ₃ =42.17MHz 80dBμ CW (Mixed signal) |
| 13 | f ₀ =45.75MHz standard 10-step modulation Sync ratio 28.6% AM=87.5%video modulation Sync chip level 90dBμ |
| 14 | f ₀ =45.75MHz 93dBμ CW |
| 15 | f ₀ =45.75MHz 73dBμ CW |
| 16 | f ₀ =4.5MHz 100dBμ fm=400Hz FM±25kHz dev |
| 17 | f ₀ =4.5MHz 50dBμ CW |
| 20 | f ₀ =4.5MHz 100dBμ fm=400Hz AM30% |
| 22 | f=1kHz 1V _{P-P} CW |

**INPUT SIGNAL PARAMETERS INCLUDING
INPUT SIGNALS**

1. Input signal name is two alphanumeric characters.

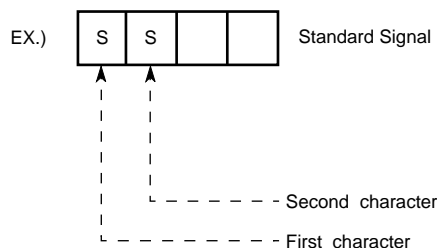

First character: Standard=S, Nonstandard=V
(Modified parts should be specified.)

Second character: Meaning of signal

2. Structure of input color signal

The following figure shows the structure of color signal.

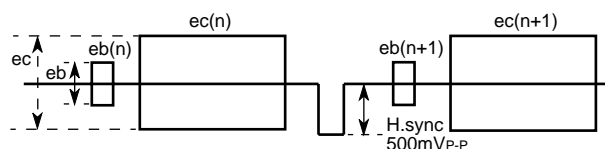

1) When S (standard) is used as the first character, the standard color bar signal of each system is applied. H.sync should be added for input clamp.

2) Amplitude and frequency of burst are represented as ed. In case of standard signal, the amplitude is 285mV_{P-P}.

3) Amplitude and frequency of chroma are represented as ec. In case of standard signal, the amplitude is 570mV_{P-P} and the frequency is 3.579545MHz.

VIF, SIF, VIDEO, CHROMA, DEFLECTION FOR NTSC

VIDEO/INTERFACE

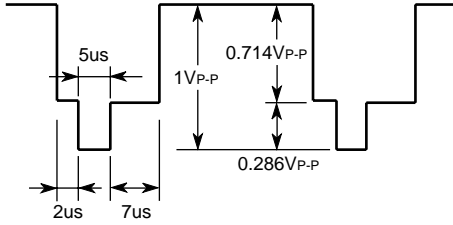
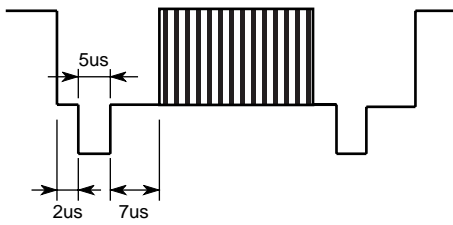
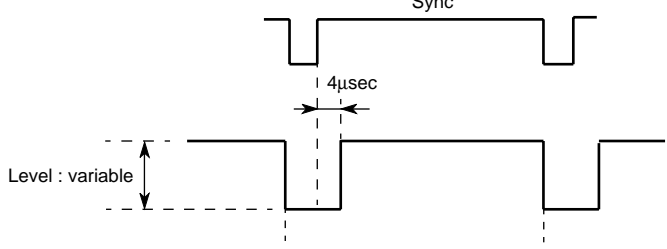
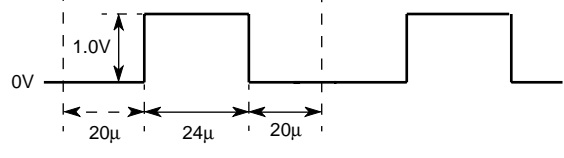
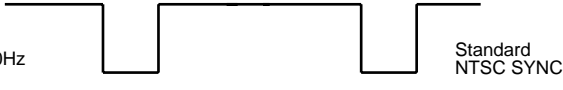
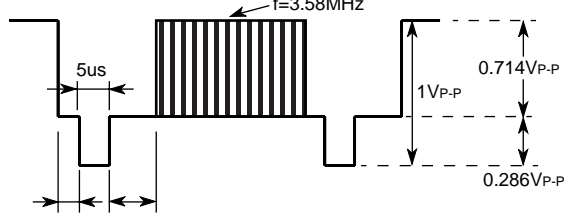
| SG No. | Signal (50Ω termination) |
|--------|--|
| SGA | <p>NTSC system APL100% standard video signal should be input as sync separation input as shown in the figure. The vertical signal should be interlaced at 60Hz.</p>  |
| SGB | <p>The frequency and amplitude of signal Lumi can be changed by signal SGA. The typical amplitude is 0.714mVp-p.</p>  |
| SGC |  <p>Level : variable</p> |
| SGD |  <p>0V</p> <p>1.0V</p> <p>20µ</p> <p>24µ</p> <p>20µ</p> |
| SGS | <p>Level : variable typ=0.3Vp-p H=15.734kHz, V=60Hz</p>  <p>Standard NTSC SYNC</p> |
| SGF |  <p>f=3.58MHz</p> <p>5µs</p> <p>1Vp-p</p> <p>0.714Vp-p</p> <p>0.286Vp-p</p> |

VIF, SIF, VIDEO, CHROMA, DEFLECTION FOR NTSC

DEFLECTION

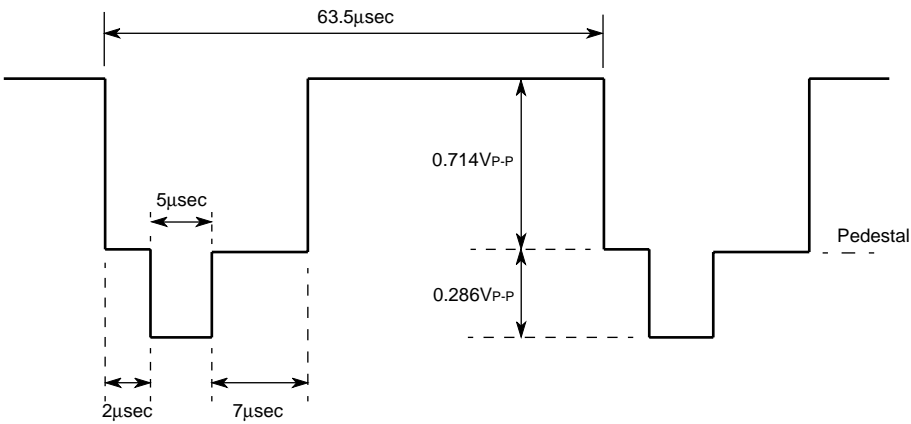
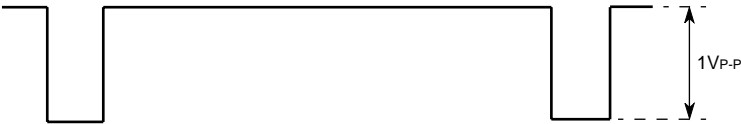
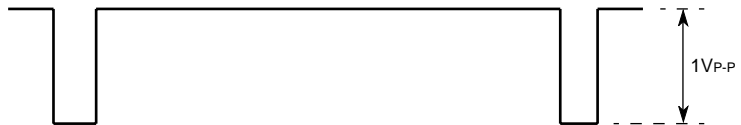
| SG No. | Signal (50Ω termination) |
|--------|--|
| SGa | <p>The input signal should be NTSC system APL-variable video signal. Vertical should be interlaced at 60Hz.</p>  <p>The diagram shows a video signal waveform. Key parameters are: <ul style="list-style-type: none"> Line duration: 63.5 μsec Vertical sync pulse width: 5 μsec Vertical sync pulse rise/fall time: 2 μsec Vertical sync pulse width (to start of line): 7 μsec Peak-to-peak amplitude of the sync pulse: 0.286 V_{P-P} Peak-to-peak amplitude of the video signal: 0.714 V_{P-P} A dashed line indicates the pedestal level. </p> |
| SGb | <p>Duty90% Frequency:variable Level:variable (Typ. :1V_{P-P})</p>  <p>The diagram shows a square wave pulse with a 90% duty cycle. The peak-to-peak amplitude is 1 V_{P-P}.</p> |
| SGc | <p>Duty95% Frequency:variable Level:variable (Typ. :1V_{P-P}) Duty: variable (95%)</p>  <p>The diagram shows a square wave pulse with a 95% duty cycle. The peak-to-peak amplitude is 1 V_{P-P}.</p> |

M52775FP

VIF, SIF, VIDEO, CHROMA, DEFLECTION FOR NTSC

TEST CIRCUIT

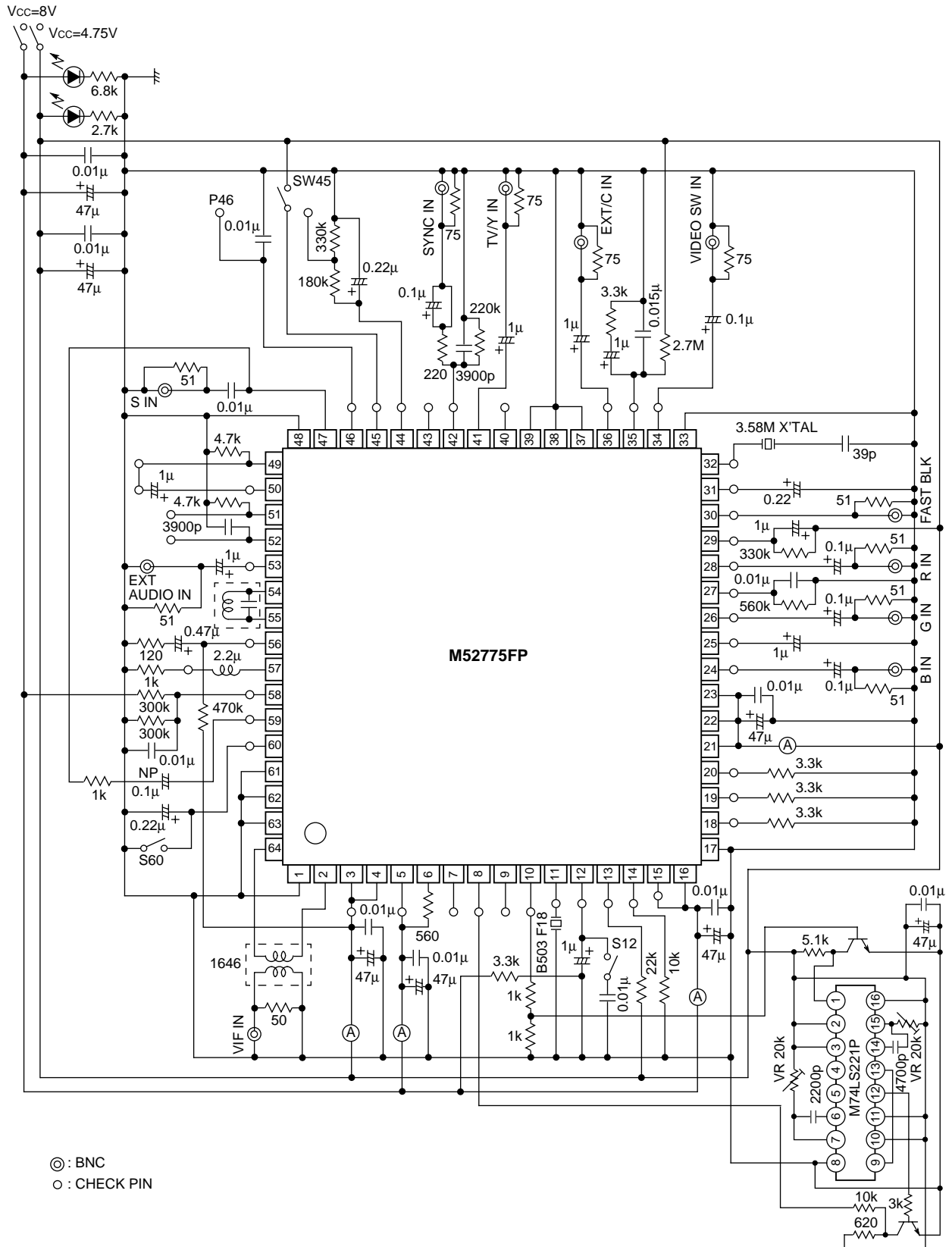

⊙ : BNC
○ : CHECK PIN

Units Resistance : Ω
Capacitance : F

TYPICAL CHARACTERISTICS

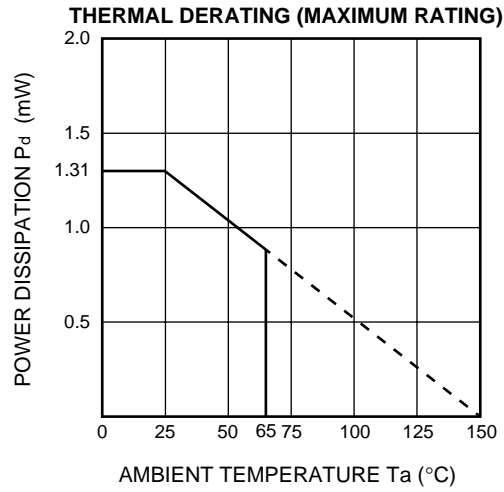

APPLICATION EXAMPLE

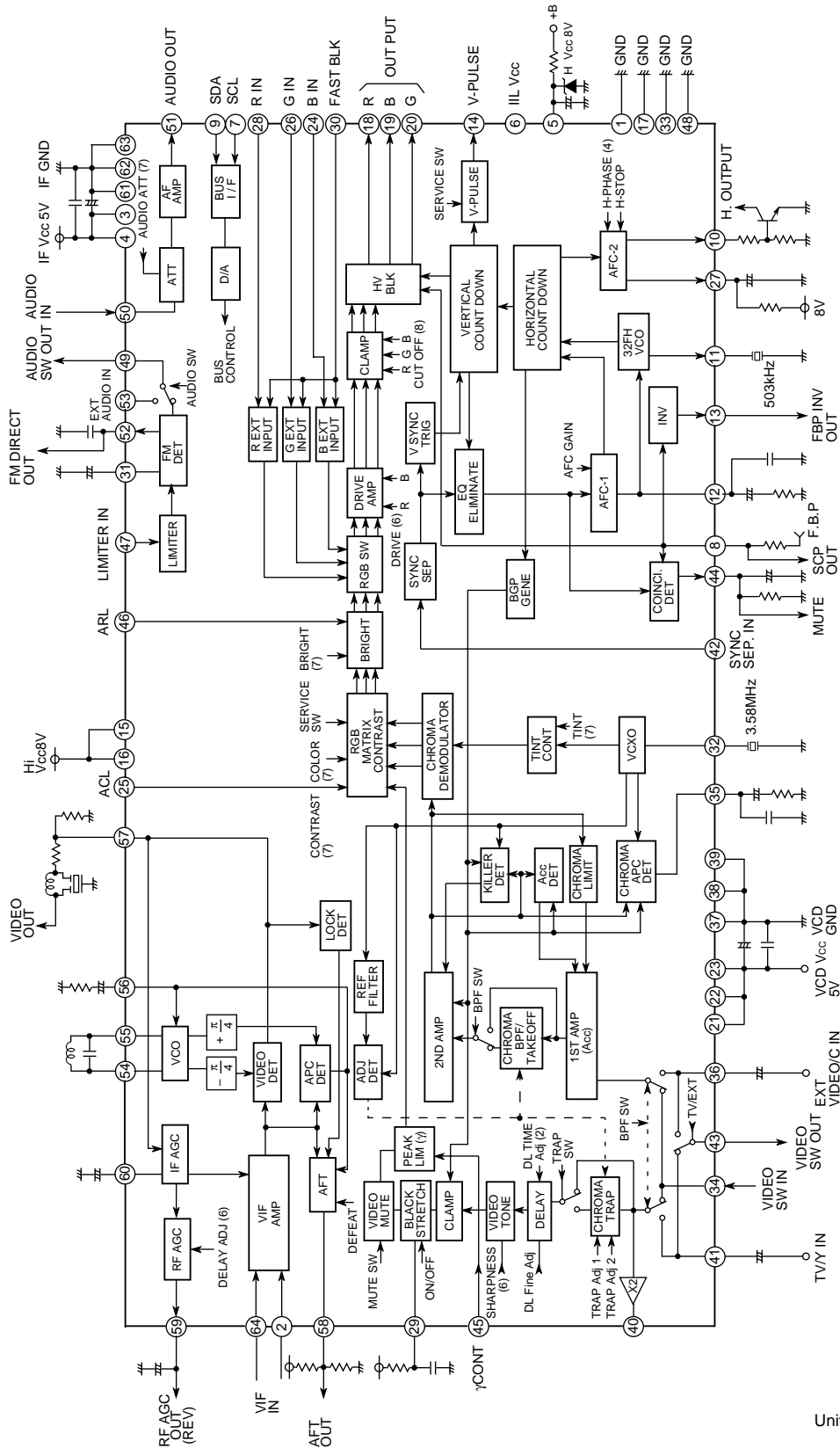

DESCRIPTION OF PIN

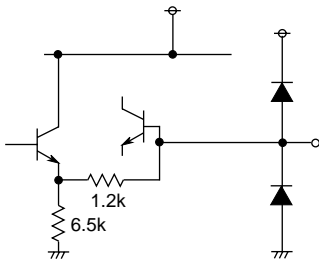
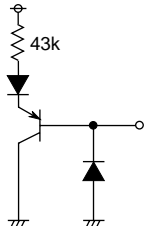
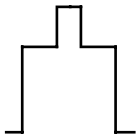
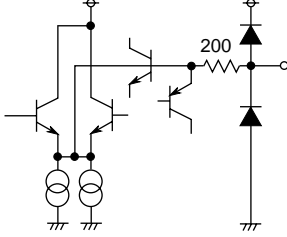
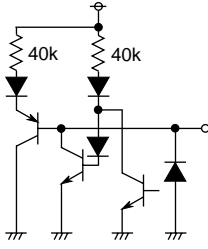
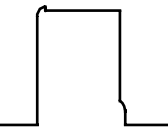
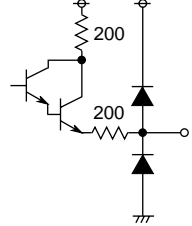
| Pin No. | Name | Pin wave | Peripheral circuit of pins | Pin voltage (V) | Remark |
|---------|--------------------|---|--|---------------------|---------------------|
| 1 | GND | — | — | — | |
| 2 64 | IF IN | — |  | 1.45 | |
| 3 4 | IF Vcc1 IF Vcc2 | — | — | 4.75 | |
| 5 | H Vcc | — | — | 8.0 | |
| 6 | ILL Vcc | — | — | 1.5 | |
| 7 | SCL | — |  | — | |
| 8 | FBP IN |  |  | 4.20 3.1 1.55 | BGP HBLK VBLK |
| 9 | SDA | — |  | — | |
| 10 | H OUT |  |  | 3.70 0 | H L |

VIF, SIF, VIDEO, CHROMA, DEFLECTION FOR NTSC

DESCRIPTION OF PIN (cont.)

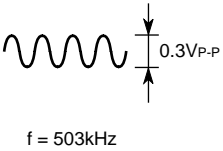
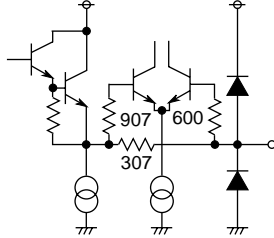
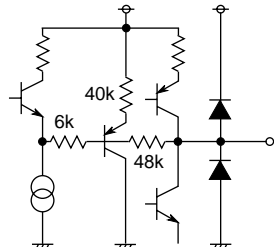
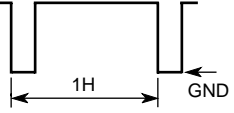
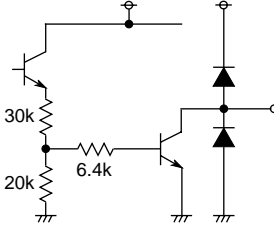
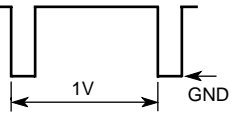
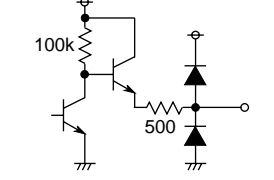
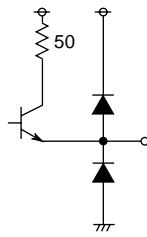
| Pin No. | Name | Pin wave | Peripheral circuit of pins | Pin voltage (V) | Remark |
|----------------|----------------------------------|--|--|-----------------|--------|
| 11 | H OSC |  <p>0.3V_{p-p} f = 503kHz</p> |  | 3.2 | |
| 12 | AFC1 FILTER | - |  | 5.1 | |
| 13 | FBP INV OUT |  <p>1H GND</p> |  | 8.0 0.2 | H L |
| 14 | V PULSE |  <p>1V GND</p> |  | 6.5 0 | H L |
| 15 | Hi Vcc1 | - | - | 8.0 | |
| 16 | Hi Vcc2 | - | - | 8.0 | |
| 17 | GND | - | - | 0 | |
| 18 19 20 | R OUT G OUT B OUT | - |  | 2.5 0 | H L |
| 21 22 23 | VCD Vcc1 VCD Vcc2 VCD Vcc3 | - | - | 4.75 | |

M52775FP

VIF, SIF, VIDEO, CHROMA, DEFLECTION FOR NTSC

DESCRIPTION OF PIN (cont.)

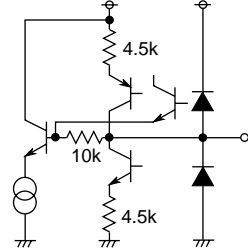
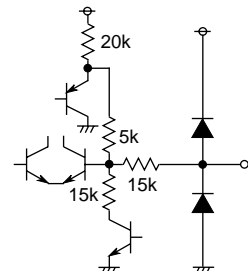
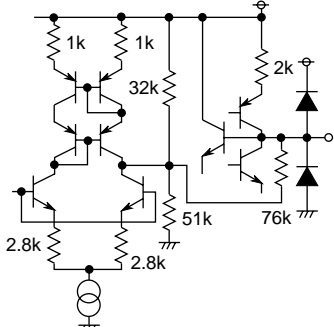
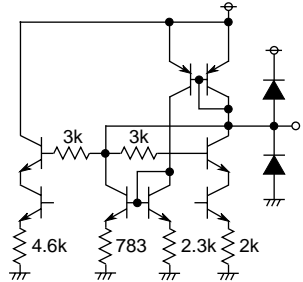
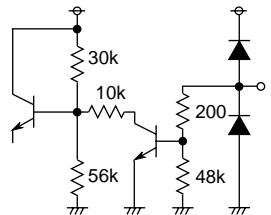
| Pin No. | Name | Pin wave | Peripheral circuit of pins | Pin voltage (V) | Remark |
|----------------|-----------------------|----------|--|-----------------|--------|
| 24 26 28 | B IN G IN R IN | - |  | 2.6 | |
| 25 | CONTRAST CONT. | - |  | 3.1 | |
| 27 | AFC2 FILTER | - |  | 5.4 | |
| 29 | BLACK PEAK HOLD | - |  | 2.2 | |
| 30 | FAST BLK | - |  | 0 | |

M52775FP

VIF, SIF, VIDEO, CHROMA, DEFLECTION FOR NTSC

DESCRIPTION OF PIN (cont.)

| Pin No. | Name | Pin wave | Peripheral circuit of pins | Pin voltage (V) | Remark |
|----------------|-------------------|--|----------------------------|-----------------|--------|
| 31 | AUDIO BYPASS | - | | 2.7 | |
| 32 | X-TAL 3.58 | $f = 3.58\text{MHz}$ 0.1V _{P-P} | | 2.7 | |
| 33 | GND | - | - | 0 | |
| 34 | VIDEO SW IN | - | | 2.1 | |
| 35 | CHROMA APC FILTER | - | | 2.9 | |
| 36 | EXT/C IN | - | | 2.0 | |
| 37 38 39 | VCD GND | - | - | 0 | |

M52775FP

VIF, SIF, VIDEO, CHROMA, DEFLECTION FOR NTSC

DESCRIPTION OF PIN (cont.)

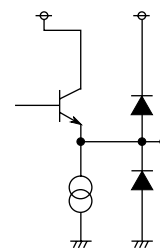
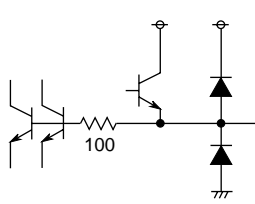
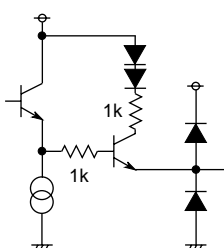
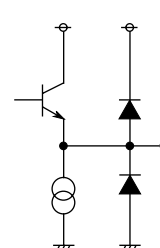
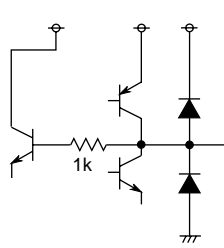
| Pin No. | Name | Pin wave | Peripheral circuit of pins | Pin voltage (V) | Remark |
|---------|-------------------|----------|--|-----------------|--------|
| 40 | Y SW OUT | - |  | 2.0 | |
| 41 | TV/Y IN | - |  | 2.0 | |
| 42 | SYNC SEP IN | - |  | 5.9 | |
| 43 | VIDEOSW OUT | - |  | 1.4 | |
| 44 | COINCI- DENCE | - |  | 0.2 | |

VIF, SIF, VIDEO, CHROMA, DEFLECTION FOR NTSC

DESCRIPTION OF PIN (cont.)

| Pin No. | Name | Pin wave | Peripheral circuit of pins | Pin voltage (V) | Remark |
|---------|----------------|----------|----------------------------|-----------------|--------|
| 45 | γ -CONT | - | | 3.0 | |
| 46 | ABL | - | | 2.2 | |
| 47 | LIMITER IN | - | | 1.9 | |
| 48 | GND | - | - | 0 | |
| 49 | AUDIO SW OUT | - | | 2.4 | |
| 50 | AUDIO IN | - | | 2.4 | |

VIF, SIF, VIDEO, CHROMA, DEFLECTION FOR NTSC

DESCRIPTION OF PIN (cont.)

| Pin No. | Name | Pin wave | Peripheral circuit of pins | Pin voltage (V) | Remark |
|----------|------------------|--|----------------------------|-----------------|--------|
| 51 | AUDIO OUT | - | | 3.3 | |
| 52 | FM DIRECT OUT | - | | 2.4 | |
| 53 | EXT AUDIO IN | - | | 1.9 | |
| 54 55 | VCO | $f = 45.75\text{MHz}$ 0.28V _{P-P} | | 4.0 | |
| 56 | VIDEO APC FILTER | - | | 2.6 | |

VIF, SIF, VIDEO, CHROMA, DEFLECTION FOR NTSC

DESCRIPTION OF PIN (cont.)

| Pin No. | Name | Pin wave | Peripheral circuit of pins | Pin voltage (V) | Remark |
|----------------|---------------|----------|----------------------------|-----------------|--------|
| 57 | VIDEO OUT | - | | 3.6 | |
| 58 | AFT OUT | - | | 4.0 | |
| 59 | RF AGC OUT | - | | 7.7 | |
| 60 | IF AGC FILTER | - | | 4.2 | |
| 61 62 63 | IF GND | - | - | 0 | |