

PRELIMINARY

Notice. This is not a final specification.
Some parametric limits are subject to change.

MITSUBISHI ICs (AV COMMON)

M52791SP/FP

AV SWITCH with I2C BUS CONTROL

DESCRIPTION

The M52791 is AV switch semiconductor integrated circuit with I2C bus control .

This IC contains 1-channel of 4-input audio switches and 1-channel of 4-input video switches. Each audio switches and video switches can be controled independently .

The video switches contain amplifiers can be controled a gain of output 0dB or 6dB .

FEATURES

- Video and stereo sound switches in one package
- Wide frequency range (video switch).....DC~20MHz
- High separation (video switch)
.....Crosstalk -60dB (typ.) at 1MHz
- Two types of packages are provided : SDIP with a lead pitch of 1.778mm (M52791SP) ; and SSOP with a lead pitch of 0.8mm (M52791FP) .

APPLICATION

Video equipment

RECOMMENDED OPERATING CONDITION

Supply voltage	4.7V ~ 9.3V
Rated supply voltage	5V,9V
Maximum output current	49mA(at 9V)

PIN CONFIGURATION (TOP VIEW)

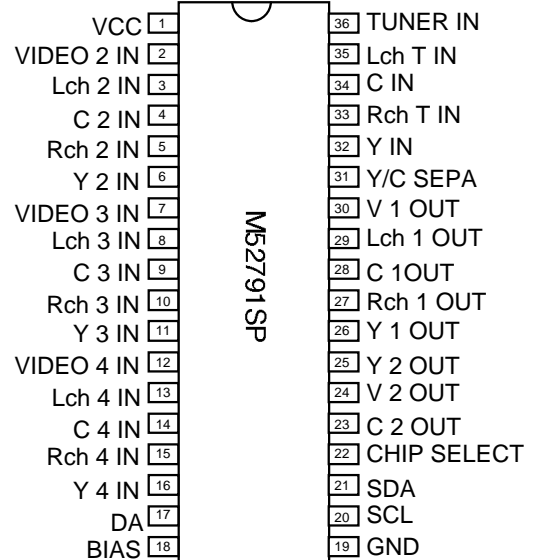

Outline 36P4E
(Lead pitch :1.778mm)

PIN CONFIGURATION (TOP VIEW)

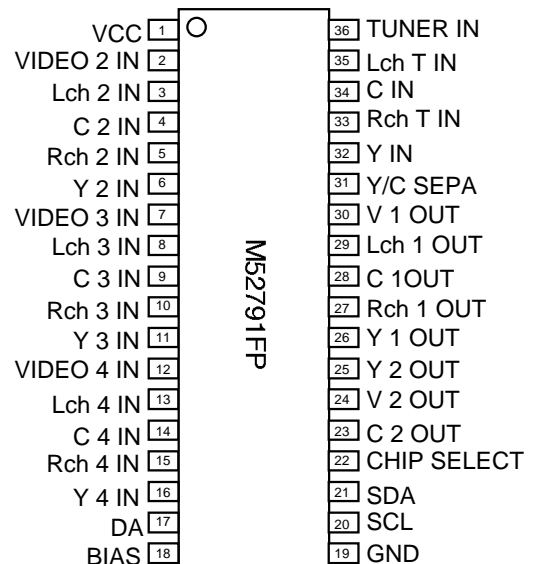

Outline 36P2R-D
(Lead pitch :0.8mm)

PRELIMINARY

Notice. This is not a final specification.
Some parametric limits are subject to change.

MITSUBISHI ICs (AV COMMON)

M52791SP/FP

AV SWITCH with I²C BUS CONTROL

BLOCK DIAGRAM

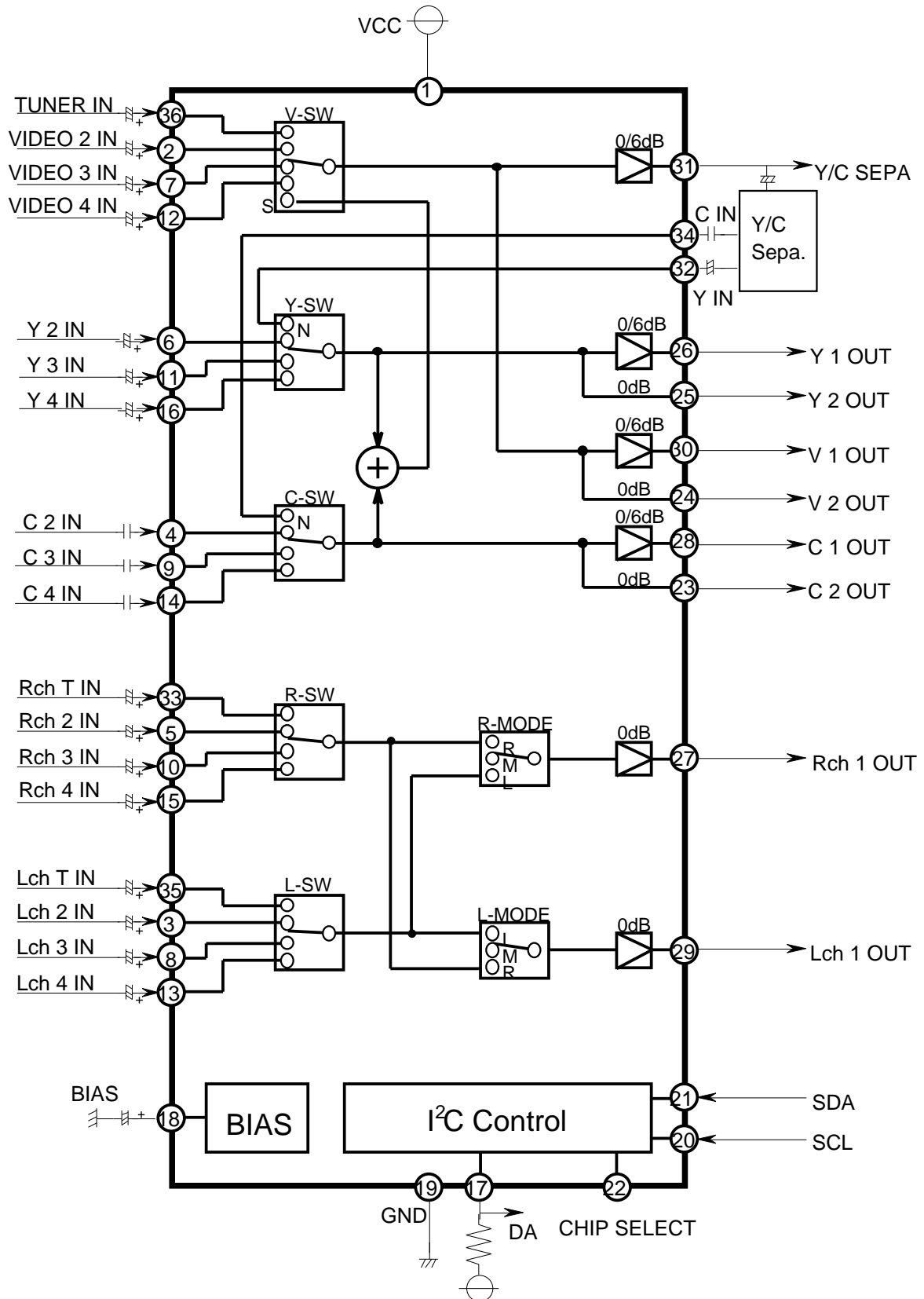

PRELIMINARY

Notice. This is not a final specification.
Some parametric limits are subject to change.

MITSUBISHI ICs (AV COMMON)

M52791SP/FP

AV SWITCH with I2C BUS CONTROL

DESCRIPTION OF PIN

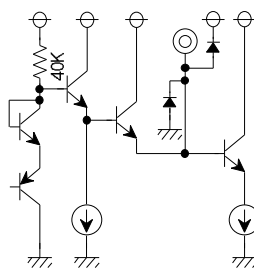
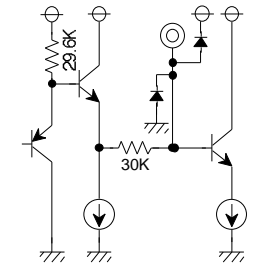
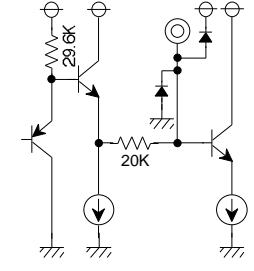
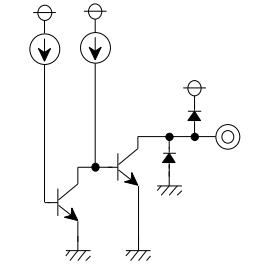
Pin No.	Name	Peripheral circuit pins	DC voltage(V)	Remarks
1	VCC		9V	5~9V
2	VIDEO 2 IN		3.6V	Clamp in
6	Y 2 IN			
7	VIDEO 3 IN			
11	Y 3 IN			
12	VIDEO 4 IN			
16	Y 4 IN			
32	Y IN			
36	TUNER IN			
3	Lch 2 IN		4.7V	
5	Rch 2 IN			
8	Lch 3 IN			
10	Rch 3 IN			
13	Lch 4 IN			
15	Rch 4 IN			
33	Rch T IN			
35	Lch T IN			
4	C 2 IN		4.7V	
9	C 3 IN			
14	C 4 IN			
34	C IN			
17	DA			VOL max.=0.4V (at Iin=1mA)

PRELIMINARY

Notice. This is not a final specification.
Some parametric limits are subject to change.

MITSUBISHI ICs (AV COMMON)

M52791SP/FP

AV SWITCH with I2C BUS CONTROL

DESCRIPTION OF PIN (cont.)

Pin No.	Name	Peripheral circuit pins	DC voltage(V)	Remarks
18	BIAS		4.2V	
19	GND			
20	SCL			$V_{IL\ max.}=1.5V$ $V_{IH\ min.}=3.0V$
21	SDA			$V_{IL\ max.}=1.5V$ $V_{IH\ min.}=3.0V$ $V_{OL\ max.}=0.4V$ (at $I_{in}=3mA$)
22	CHIP SELECT			SLAVE ADDRESS 0~1.5V-----90H 2.5V~V _{CC} ---92H OPEN-----90H

PRELIMINARY

Notice. This is not a final specification.
Some parametric limits are subject to change.

MITSUBISHI ICs (AV COMMON)

M52791SP/FP

AV SWITCH with I2C BUS CONTROL

DESCRIPTION OF PIN (cont.)

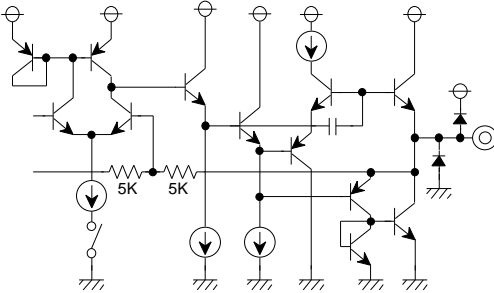
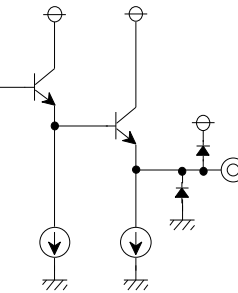
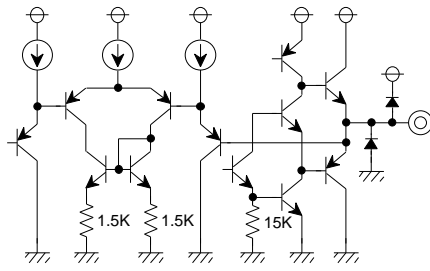
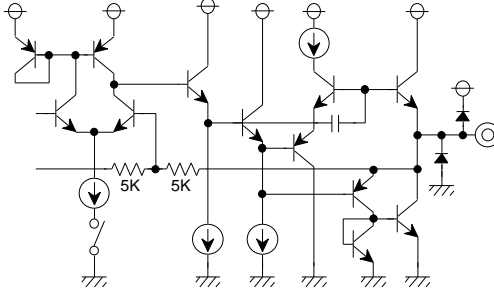
Pin No.	Name	Peripheral circuit pins	DC voltage(V)	Remarks
26 28 30	Y 1 OUT C 1 OUT V 1 OUT		C OUT 4.0V V OUT Y OUT SYNC CHIP DC=2.9V	
23 24 25	C 2 OUT V 2 OUT Y 2 OUT		C OUT 3.3V V OUT Y OUT SYNC CHIP DC=2.2V	
27 29	Rch 1 OUT Lch 1 OUT		4.0V	
31	Y/C SEPA		SYNC CHIP DC=2.9V	

PRELIMINARY

Notice. This is not a final specification.
Some parametric limits are subject to change.

MITSUBISHI ICs (AV COMMON)

M52791SP/FP

AV SWITCH with I2C BUS CONTROL

I²C BUS

I²C BUS (Inter IC BUS) is multi master bus system developed by PHILIPS . Two wires (SDA - serial data, SCL - serial clock) realize functions of start , stop , transferring data , synchronization and arbitration. The output stages of device connected to the bus must have an open drain or open collector in order to perform the wired-AND function .

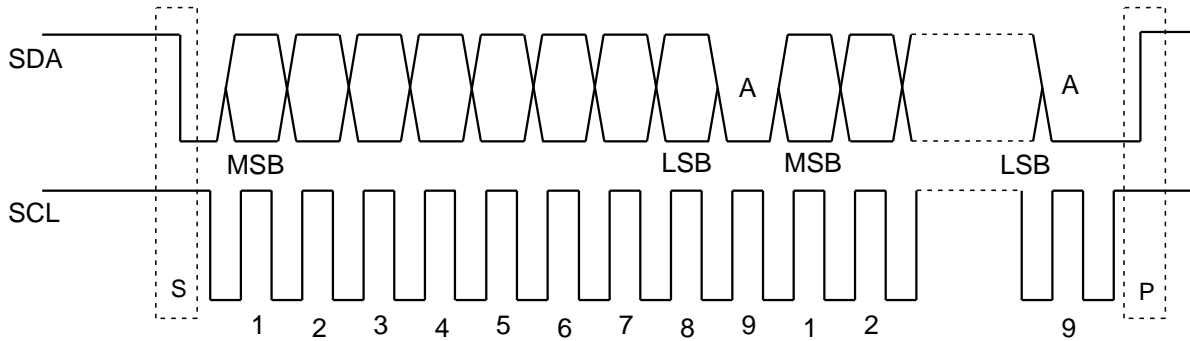

S ; Start condition, a high to low transition of the SDA line while SCL is high
P ; Stop condition, a low to high transition of the SDA line while SCL is high
A : Acknowledge

Every byte put on the SDA line must be 8-bits long . Each byte has to be followed by an acknowledge bit. Data is transferred with the most significant bit (MSB) first . The data on the SDA line must be stable during the HIGH period of the clock . The HIGH or LOW state of the data line can only change when the clock signal on the SCL line is LOW .

CONTROL

This IC controls 2-channel switches with 2-byte data (DATA1 and DATA2) . Video switches are controlled by DATA1 . audio switches are controlled by DATA2 .



S : Start
A : Acknowledge
P : Stop

SLAVE ADDRESS

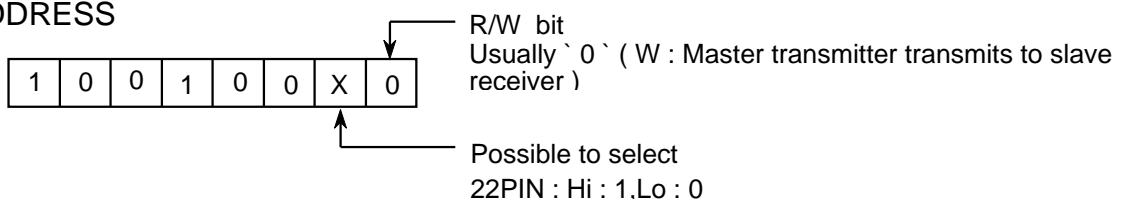

PRELIMINARY

Notice. This is not a final specification.
Some parametric limits are subject to change.

MITSUBISHI ICs (AV COMMON)

M52791SP/FP

AV SWITCH with I2C BUS CONTROL

Data byte format

M52791 FUNCTION TABLE

S	SLAVE ADDRESS	A	DATA(D7~D0)	A	DATA(DF~D8)	A	P
---	---------------	---	-------------	---	-------------	---	---

SLAVE ADDRESS

SLAVE ADDRESS	A6	A5	A4	A3	A2	A1	A0	R/W
	1	0	0	1	0	0	0/1	0

DATA1(D7~D0) CONT

DATA	D7	D6	D5	D4	D3	D2	D1	D0
CONT	0 FIX	0 FIX	SEPA AMP	Y/C AMP	V AMP1	S/N	VIDEO SW CONT	

VIDEO SW CONT

DATA			OUT		
S/N(S:1)	V-SW		V OUT	Y OUT	C OUT
D2	D1	D0	Y/C SEPA		
0	0	0	0 T IN	Y IN	C IN
0	0	0	1 V 2 IN	Y IN	C IN
0	1	0	0 V 3 IN	Y IN	C IN
0	1	1	1 V 4 IN	Y IN	C IN
1	0	0	0 Y/C MIX T	Y IN	C IN
1	0	1	1 Y/C MIX 2	Y 2 IN	C 2 IN
1	1	1	0 Y/C MIX 3	Y 3 IN	C 3 IN
1	1	1	1 Y/C MIX 4	Y 4 IN	C 4 IN

AMP GAIN CONT.

DATA	AMP	DATA	AMP	DATA	AMP
D5	SEPA AMP	D4	YC AMP	D3	V AMP
0	0dB	0	0dB	0	0dB
1	6dB	1	6dB	1	6dB

DATA2(DF~D8) CONT

DATA	DF	DE	DD	DC	DB	DA	D9	D8
CONT	AUDIO MODE		0 FIX	0 FIX	0 FIX	I/O	AUDIO SW CONT	

AUDIO SW CONT

MODE		MUTE		R/R		L/L		NORMAL	
DATA		OUT		OUT		OUT		OUT	
D9	D8	Lch OUT 1	Rch OUT 1	Lch OUT 1	Rch OUT 1	Lch OUT 1	Rch OUT 1	Lch OUT 1	Rch OUT 1
0	0	MUTE	MUTE	Rch T IN	Rch T IN	Lch T IN	Lch T IN	Lch T IN	Rch T IN
0	1	MUTE	MUTE	Rch 2 IN	Rch 2 IN	Lch 2 IN	Lch 2 IN	Lch 2 IN	Rch 2 IN
1	0	MUTE	MUTE	Rch 3 IN	Rch 3 IN	Lch 3 IN	Lch 3 IN	Lch 3 IN	Rch 3 IN
1	1	MUTE	MUTE	Rch 4 IN	Rch 4 IN	Lch 4 IN	Lch 4 IN	Lch 4 IN	Rch 4 IN

I/O CONT.

DATA	OUT
DA	DA OUT
0	HI
1	LO

AUDIO MODE CONT

DATA		MODE
DF	DE	
0	0	MUTE
0	1	R/R
1	0	L/L
1	1	NORMAL

PRELIMINARY

Notice. This is not a final specification.
Some parametric limits are subject to change.

MITSUBISHI ICs (AV COMMON)

M52791SP/FP

AV SWITCH with I2C BUS CONTROL

ELECTRICAL CHARACTERISTICS

(Ta=25°C, Vcc=9V, unless otherwise noted)

Parameter	Symbol	Test condition	Min.	Typ.	Max.	Unit
Supply voltage	Vcc		4.7	-	9.3	V
Circuit current	Icc	Vcc=9V, Vin=0Vp-p, RI=	-	49	64	mA
		Vcc=5V, Vin=0Vp-p, RI=	-	42	55	
VIDEO						
Voltage gain	G	f=100kHz, 1Vp-p (0dB)(T→V1OUT)	-0.5	0	0.5	dB
		f=100kHz, 1Vp-p (6dB)(T→V1OUT)	5.5	6	6.5	
		f=100kHz, 1Vp-p (0dB)(Y→V1OUT)	-0.5	0	0.5	
		f=100kHz, 1Vp-p (6dB)(Y→V1OUT)	5.5	6	6.5	
Frequency characteristics	F	f=10MHz/100kHz, 1Vp-p (0dB)(T→V1OUT)	-2.0	0	2.0	dB
		f=10MHz/100kHz, 1Vp-p (6dB)(T→V1OUT)	-2.0	0	2.0	
		f=10MHz/100kHz, 1Vp-p (0dB)(Y→V1OUT)	-2.0	0	2.0	
		f=10MHz/100kHz, 1Vp-p (6dB)(Y→V1OUT)	-2.0	0	2.0	
Dynamic Range	D	Vcc=9V(0dB)(T→V1OUT)	4	-	-	Vp-p
		Vcc=5V(0dB)(T→V1OUT)	2	-	-	
		Vcc=9V(0dB)(Y→V1OUT)	4	-	-	
		Vcc=5V(0dB)(Y→V1OUT)	2	-	-	
Input impedance	ZIC	(C, C2, C3, C4)	14	20	26	k
	ZIV	Clamp in(T, V2, V3, V4)	-	-	-	
	ZIY	Clamp in(Y, Y2, Y3, Y4)	-	-	-	
Crosstalk	CT	f=1MHz, 1Vp-p T→V1OUT (at V2 mode)	-	-60	-54	dB
AUDIO						
Voltage gain	G	f=1kHz, 1Vp-p (Vcc9V)(RT→R1OUT)	-0.5	0	0.5	dB
		f=1kHz, 1Vp-p (Vcc5V)(RT→R1OUT)	-0.5	0	0.5	
Frequency characteristics	F	f=100kHz/1kHz, 1Vp-p(RT→R1OUT)	-1	0	1	dB
Total harmonic distortion	THD	f=1kHz, 2Vp-p, at 400HzHPF+30kHzLPF (RT→R1OUT)	-	0.01	0.05	%
Dynamic Range	D	f=1kHz, Maximum with distortion<0.5% (RT→R1OUT)	5.5	6.0	-	Vp-p
Output DC offset voltage	VOFF	(MODE:RT, R2, R3, R4→R1OUT)	-20	0	20	mV
Input impedance	Z1	(RT, R2, R3, R4, LT, L2, L3, L4)	22	30	38	k
Crosstalk	CT	1kHz, 1Vp-p RT→R1OUT(at R2 mode)	-	-90	-84	dB

PRELIMINARY

Notice. This is not a final specification.
Some parametric limits are subject to change.

MITSUBISHI ICs (AV COMMON)

M52791SP/FP

AV SWITCH with I2C BUS CONTROL

ELECTRICAL CHARACTERISTICS

(Ta=25°C, Vcc=9V, unless otherwise noted)

Parameter	Symbol	Test condition	Min.	Typ.	Max.	Unit
I2C BUS CONTROL SIGNAL						
Max. input high voltage	V _{IH}		3.0	-	5.0	V
Min. input low voltage	V _{IL}		0.0	-	1.5	
Low level output voltage(SDA)	V _{OL}	SDA = 3mA	0.0	-	0.4	
High level input current	I _{IH}	SDA, SCL = 4.5 V	-10	-	10	μA
Low level input current	I _{IL}	SDA, SCL = 0.4 V	-10	-	10	
SCL clock frequency	f _{SCL}		0.0	-	100	kHz
Time of bus must be free before a new transmission can start	t _{BUF}		4.7	-	-	μS
Hold time at start condition	t _{HD;STA}		4.0	-	-	
The low period of the clock	t _{LOW}		4.7	-	-	
The high period of the clock	t _{HIGH}		4.0	-	-	
Setup time for start condition	t _{SU;STA}		4.7	-	-	
Hold time DATA	t _{HD;DAT}		5.0	-	-	nS
Setup time DATA	t _{SU;DAT}		250	-	-	
Rise time of both SDA and SCL line	t _R		-	-	1000	
Fall time of both SDA and SCL line	t _F		-	-	300	
Setup time for stop condition	t _{SU;STO}		4.0	-	-	μS

I²C BUS CONTROL SIGNAL

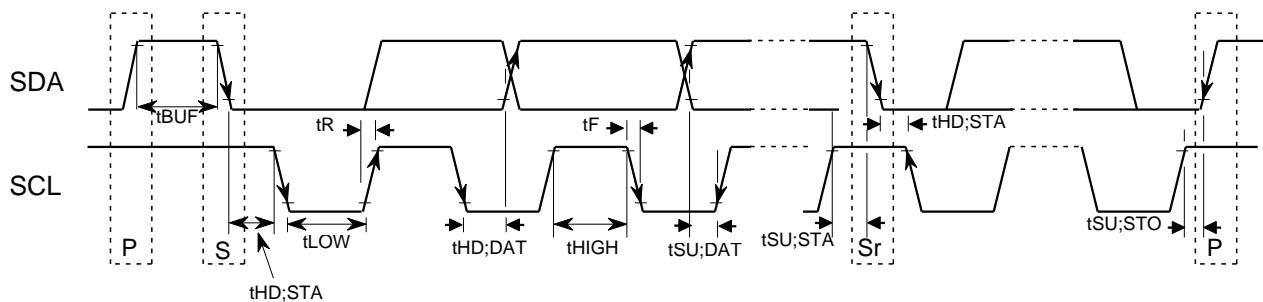

PRELIMINARY

Notice. This is not a final specification.
Some parametric limits are subject to change.

MITSUBISHI ICs (AV COMMON)

M52791SP/FP

AV SWITCH with I2C BUS CONTROL

Application Circuit Example

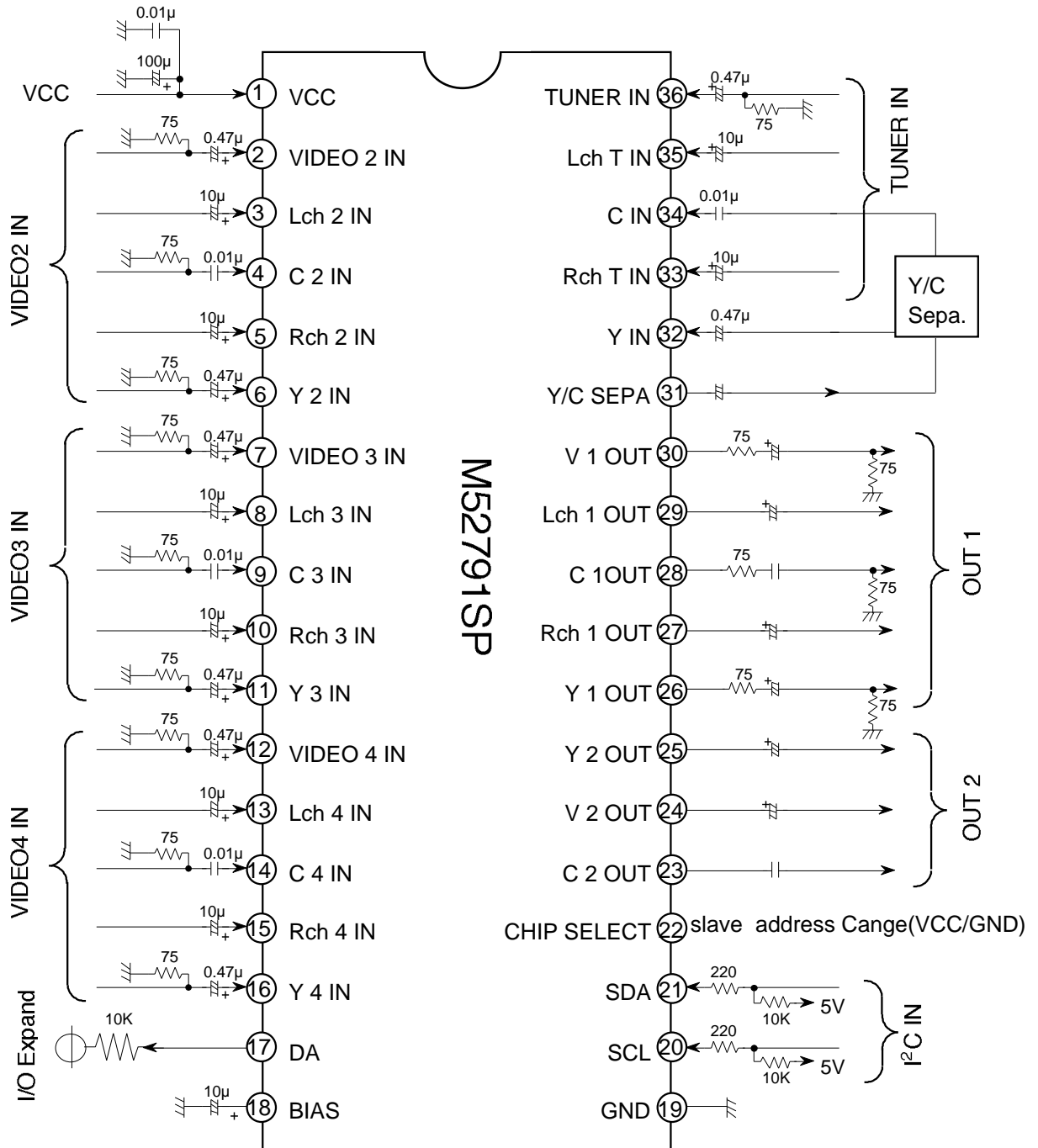

Note how to use this IC

- Input signal with sufficient low impedance to input terminal.
- The capacitance of output terminal as small as possible.
- Set the capacitance between Vcc and GND near the pins if possible.
- Assign an area as large as possible for grounding.

Power-on Reset

The M52791 has an internal power-on reset function that sets each control register to "0" during IC power ON.
The power-on reset VTH has 2.5V.