

# M57120L

HIGH VOLTAGE INPUT dc-dc CONVERTER

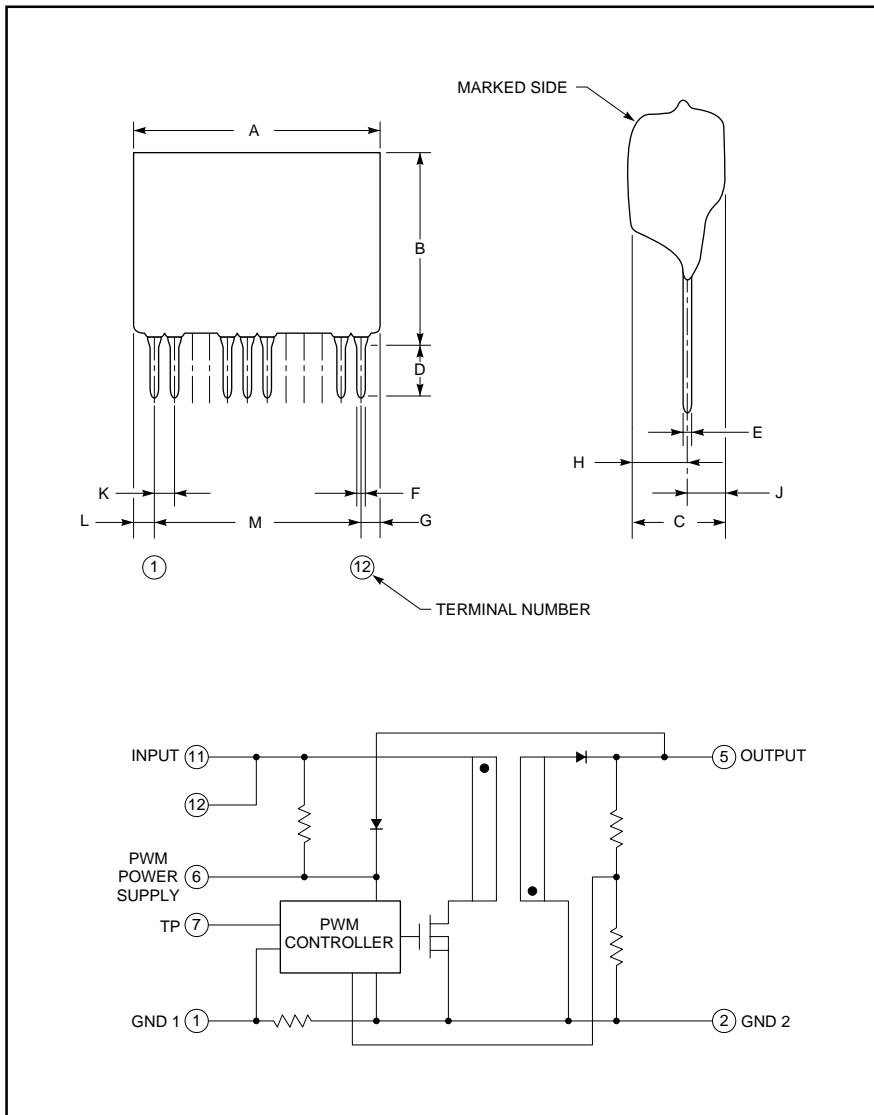

Outline Drawing and Circuit Diagram

Dimensions	Inches	Millimeters
A	1.46	37.0 MAX
B	1.46	39.0 MAX
C	.63	16.0 MAX
D	.18±.06	4.5±1.5
E	.01±.01	0.35±0.2
F	.02±0.004	0.55±0.1

Dimensions	Inches	Millimeters
G	0.16	4.0 MAX
H	0.37	9.5 MAX
J	0.26	6.5 MAX
K	0.1	2.54
L	.2	5.0 MAX
M	1.1	27.94

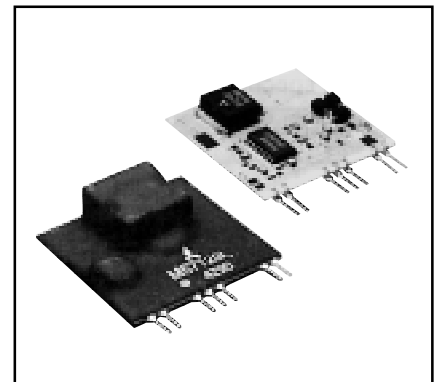

**Description:**

M57120L is a non-isolated DC-to-DC converter with a built-in transformer. Wide range of input voltage (DC 113V-400V) enables direct connection to rectified 120V and 240V AC. This device is best suited for use as a pre-regulator for standard DC-to-DC converters.

**Features:**

- Wide Range of Input Source Voltage (113V-400V DC)
- Built-in Surface-mount Transformer
- SIP Structure Enables Efficient use of PCB Area

**Applications:**

- Power Source for Standard DC-to-DC Converters
- Pre-regulator

**Ordering Information:**

M57120L

# M57120L

## HIGH VOLTAGE INPUT dc-dc CONVERTER

### Absolute Maximum Ratings, $T_a = 25\text{ }^\circ\text{C}$ unless otherwise specified

Characteristics	Symbol	Test Conditions	M57120L	Units
Input Voltage	$V_{IN}$	11, 12-1 pin	380	Volts
Operating Temperature	$T_{opr}$	There Should be	-10 ~ +75	$^\circ\text{C}$
Storage Temperature	$T_{stg}$	No Condensation	-20 ~ +85	$^\circ\text{C}$
Output Power	$P_{OW}$	-	4.4	Watts

### Electrical Characteristics, $V_{IN} = 280\text{V}$ , $T_a = 25\text{ }^\circ\text{C}$ unless otherwise specified

Characteristics	Symbol	Test Conditions	Min.	Typ.	Max.	Units
Input Source Voltage	$V_{IN}$	Direct Current	113	280	380	Volts
Circuit Current	$I_B$	$V_{IN} = 113\text{V}$	-	5.4	6.0	mA
		$V_{IN} = 280\text{V}$	-	4.9	5.5	mA
		$V_{IN} = 380\text{V}$	-	5.3	5.9	mA
Output Voltage	$V_O$	$I_L = 0 \sim 200\text{mA}$	18	20	22	Volts
Load Current	$I_L$	$V_{IN} = 113 \sim 380\text{V}$	-	200	220	mA
Input Regulation	Reg-in	$V_{IN} = 113 \sim 380\text{V}$	-	-0.8	-1.4	Volts
Output Regulation	Reg-out	$I_L = 0 \sim 200\text{mA}$	-	1.2	2.0	Volts

### Application Circuit

WHEN INPUT-OUTPUT GND ARE SEPARATED

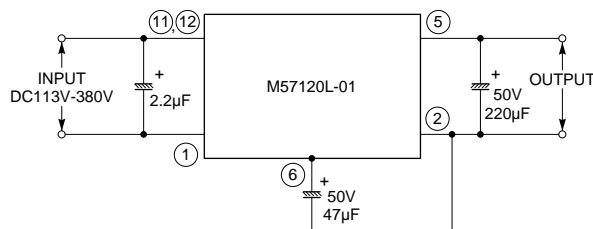

WHEN INPUT-OUTPUT GND ARE NOT SEPARATED

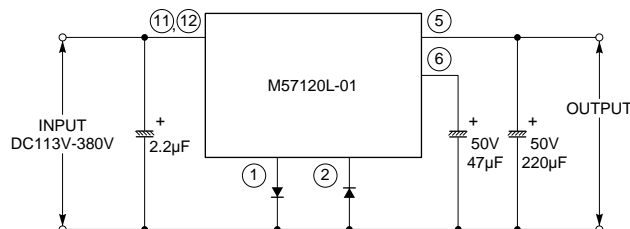

# M57120L

## HIGH VOLTAGE INPUT dc-dc CONVERTER

DERATING CURVE

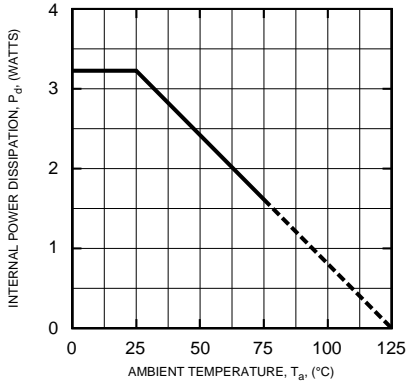

OUTPUT VOLTAGE - LOAD CURRENT CHARACTERISTICS

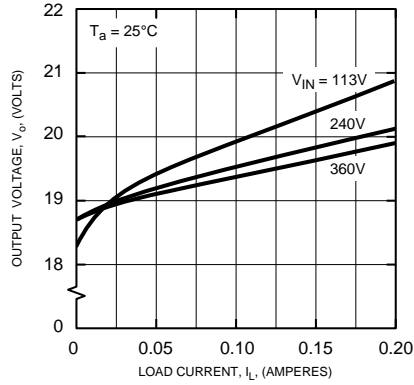

OUTPUT VOLTAGE - INPUT VOLTAGE CHARACTERISTICS

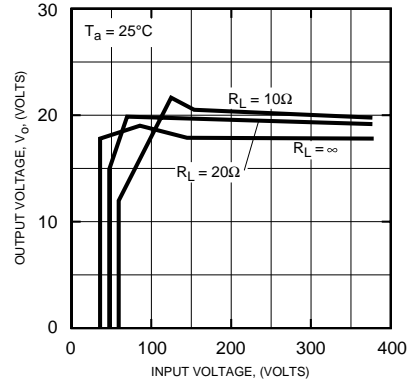

OUTPUT VOLTAGE - AMBIENT TEMPERATURE CHARACTERISTICS

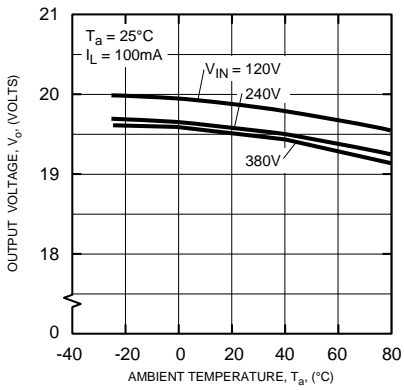

OUTPUT REGULATION

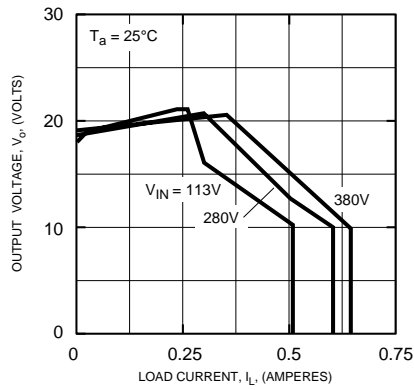

BIAS CURRENT AMBIENT TEMPERATURE CHARACTERISTICS

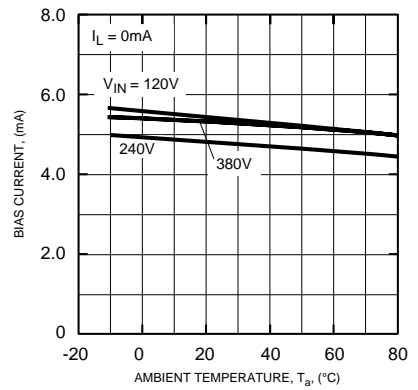

# M57120L

## HIGH VOLTAGE INPUT dc-dc CONVERTER

**BIAS CURRENT -  
INPUT VOLTAGE CHARACTERISTICS**

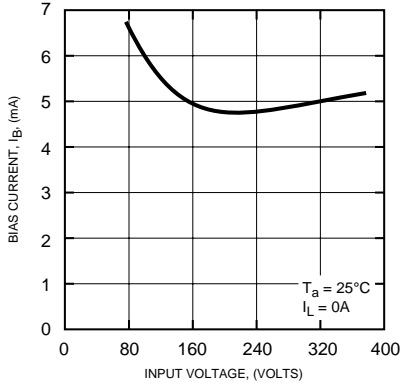

**START-UP TIME -  
INPUT VOLTAGE CHARACTERISTICS**

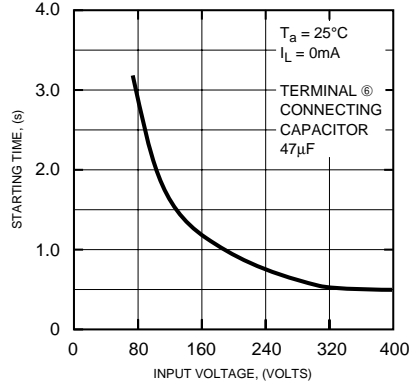

**EFFICIENCY - LOAD  
CURRENT CHARACTERISTICS**

