

M5K4164AL-12, -15

65 536-BIT (65 536-WORD BY 1-BIT) DYNAMIC RAM

DESCRIPTION

This is a family of 65 536-word by 1-bit dynamic RAMs, fabricated with the high performance N-channel silicongate MOS process, and is ideal for large-capacity memory systems where high speed, low power dissipation, and low costs are essential. The use of double-layer polysilicon process technology and a single-transistor dynamic storage cell provide high circuit density at reduced costs, and the use of dynamic circuitry including sense amplifiers assures low power dissipation. Multiplexed address inputs permit both a reduction in pins to the 16-pin zigzag inline package configuration and an increase in system densities. The M5K4164AL operates on a 5V power supply using the on-chip substrate bias generator.

FEATURES

- High speed

Type name	Access time (max) (ns)	Cycle time (min) (ns)	Power dissipation (typ) (mW)
M5K4164AL-12	120	220	175
M5K4164AL-15	150	260	150

- 16 pin zigzag inline package
- Single 5V±10% supply
- Low standby power dissipation: 22mW (max)
- Low operating power dissipation:
 - M5K4164AL-12 275mW (max)
 - M5K4164AL-15 250mW (max)
- Unlatched output enables two-dimensional chip selection and extended page boundary
- Early-write operation gives common I/O capability
- Read-modify-write, \overline{RAS} -only refresh, and page-mode capabilities

PIN CONFIGURATION (TOP VIEW)

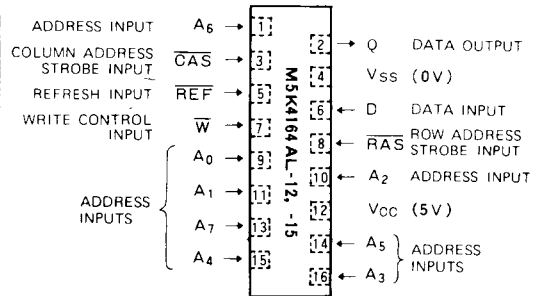

Outline 16P5A

- All input terminals have low input capacitance and are directly TTL-compatible
- Output is three-state and directly TTL-compatible
- 128 refresh cycles every 2ms (16K dynamic RAMs M5K4116P, S compatible)
- \overline{CAS} controlled output allows hidden refresh
- Output data can be held infinitely by \overline{CAS}

APPLICATION

- Main memory unit for computers
- Refresh memory for CRT

BLOCK DIAGRAM

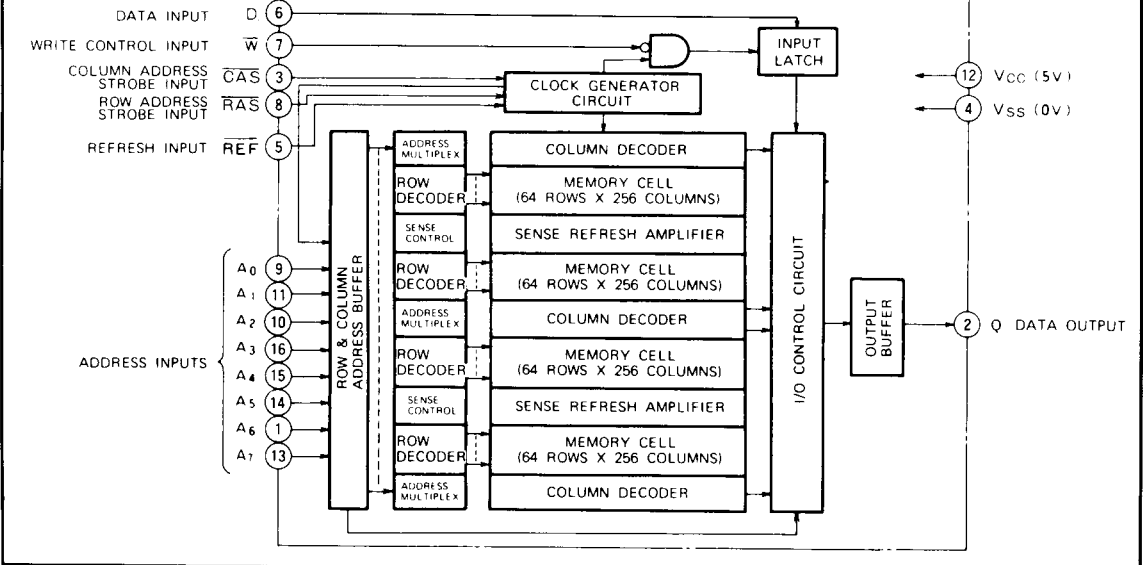

65 536-BIT (65 536-WORD BY 1-BIT) DYNAMIC RAM

FUNCTION

The M5K4164AL provides, in addition to normal read, write, and read-modify-write operations, a number of other functions, e.g., page mode, RAS-only refresh, and delayed-write. The input conditions for each are shown in Table 1.

Table 1 Input conditions for each mode

Operation	Inputs							Output	Refresh	Remarks
	RAS	CAS	W	D	Row address	Column address	REF	Q		
Read	ACT	ACT	NAC	DNC	APD	APD	NAC	VLD	YES	Page mode identical.
Write (Early write)	ACT	ACT	ACT	VLD	APD	APD	NAC	OPN	YES	
Read-modify-write	ACT	ACT	ACT	VLD	APD	APD	NAC	VLD	YES	
RAS-only refresh	ACT	NAC	DNC	DNC	APD	DNC	NAC	OPN	YES	
Hidden refresh	ACT	ACT	DNC	DNC	APD	DNC	NAC	VLD	YES	
Automatic refresh	NAC	DNC	DNC	DNC	DNC	DNC	ACT	OPN	YES	
Self refresh	NAC	DNC	DNC	DNC	DNC	DNC	ACT	OPN	YES	
Hidden automatic refresh	NAC	ACT	DNC	DNC	DNC	DNC	ACT	VLD	YES	
Hidden self refresh	NAC	ACT	DNC	DNC	DNC	DNC	ACT	VLD	YES	
Standby	NAC	DNC	DNC	DNC	DNC	DNC	NAC	OPN	NO	

Note: ACT : active, NAC : nonactive, DNC : don't care, VLD : valid, APD : applied, OPN : open.

SUMMARY OF OPERATIONS

Addressing

To select one of the 65 536 memory cells in the M5K4164AL the 16-bit address signal must be multiplexed into 8 address signals, which are then latched into the on-chip latch by two externally-applied clock pulses. First, the negative-going edge of the row-address-strobe pulse (RAS) latches the 8 row-address bits; next, the negative-going edge of the column-address-strobe pulse (CAS) latches the 8 column-address bits. Timing of the RAS and CAS clocks can be selected by either of the following two methods:

1. The delay time from RAS to CAS $t_{d(RAS-CAS)}$ is set between the minimum and maximum values of the limits. In this case, the internal CAS control signals are inhibited almost until $t_{d(RAS-CAS)max}$ ('gated CAS' operation). The external CAS signal can be applied with a margin not affecting the on-chip circuit operations, e.g. access time, and the address inputs can be easily changed from row address to column address.
2. The delay time $t_{d(RAS-CAS)}$ is set larger than the maximum value of the limits. In this case the internal inhibition of CAS has already been released, so that the internal CAS control signals are controlled by the externally applied CAS, which also controls the access time.

Data Input

Date to be written into a selected cell is strobed by the later of the two negative transitions of W input and CAS input. Thus when the W input makes its negative transition prior to CAS input (early write), the data input is strobed by CAS, and the negative transition of CAS is set as the reference point for set-up and hold times. In the read-write

or read-modify-write cycles, however, when the W input makes its negative transition after CAS, the W negative transition is set as the reference point for setup and hold times.

Data Output Control

The output of the M5K4164AL is in the high-impedance state when CAS is high. When the memory cycle in progress is a read, read-modify-write, or a delayed-write cycle, the data output will go from the high-impedance state to the active condition, and the data in the selected cell will be read. This data output will have the same polarity as the input data. Once the output has entered the active condition, this condition will be maintained until CAS goes high, irrespective of the condition of RAS.

The output will remain in the high-impedance state throughout the entire cycle in an early-write cycle.

These output conditions, of the M5K4164AL, which can readily be changed by controlling the timing of the write pulse in a write cycle, and the width of the CAS pulse in a read cycle, offer capabilities for a number of applications, as follows.

1. Common I/O Operation

If all write operations are performed in the early-write mode, input and output can be connected directly to give a common I/O data bus.

2. Data Output Hold

The data output can be held between read cycles, without lengthening the cycle time. This enables extremely flexible clock-timing settings for RAS and CAS.

65 536-BIT (65 536-WORD BY 1-BIT) DYNAMIC RAM**3. Two Methods of Chip Selection**

Since the output is not latched, $\overline{\text{CAS}}$ is not required to keep the outputs of selected chips in the matrix in a high-impedance state. This means that $\overline{\text{CAS}}$ and/or $\overline{\text{RAS}}$ can both be decoded for chip selection.

4. Extended-Page Boundary

By decoding $\overline{\text{CAS}}$, the page boundary can be extended beyond the 256 column locations in a single chip. In this case, $\overline{\text{RAS}}$ must be applied to all devices.

Page-Mode Operation

This operation allows for multiple-column addressing at the same row address, and eliminates the power dissipation associated with the negative-going edge of $\overline{\text{RAS}}$, because once the row address has been strobed, $\overline{\text{RAS}}$ is maintained. Also, the time required to strobe in the row address for the second and subsequent cycles is eliminated, thereby decreasing the access and cycle times.

Refresh

Each of the 128 rows ($A_0 \sim A_6$) of the M5K4164AL must be refreshed every 2 ms to maintain data. The methods of refreshing for the M5K4164AL are as follows.

1. Normal Refresh

Read cycle and Write cycle (early write, delayed write or read-modify-write) refresh the selected row as defined by the low order ($\overline{\text{RAS}}$) addresses. Any write cycle, of course, may change the state of the selected cell. Using a read, write, or read-modify-write cycle for refresh is not recommended for systems which utilize "wire-OR" outputs since output bus contention will occur.

2. $\overline{\text{RAS}}$ Only Refresh

A $\overline{\text{RAS}}$ -only refresh cycle is the recommended technique for most applications to provide for data retention. A $\overline{\text{RAS}}$ -only refresh cycle maintains the output in the high-impedance state with a typical power reduction of 20% over a read or write cycle.

3. Automatic Refresh

Pin 5 ($\overline{\text{REF}}$) has two special functions. The M5K4164AL has a refresh address counter, refresh address multiplexer and refresh timer for these operations. Automatic refresh is initiated by bringing $\overline{\text{REF}}$ low after $\overline{\text{RAS}}$ has precharged and is used during standard operation just like $\overline{\text{RAS}}$ -only refresh, except that sequential row addresses from an external counter are no longer necessary.

At the end of automatic refresh cycle, the internal refresh address counter will be automatically incremented. The output state of the refresh address counter is initiated by some eight $\overline{\text{REF}}$, $\overline{\text{RAS}}$ or $\overline{\text{RAS/CAS}}$ cycle after power is applied. Therefore, a special operation is not necessary to initiate it.

$\overline{\text{RAS}}$ must remain inactive during $\overline{\text{REF}}$ activated cycles. Likewise, $\overline{\text{REF}}$ must remain inactive during $\overline{\text{RAS}}$ generated cycle.

4. Self-Refresh

The other function of pin 5 ($\overline{\text{REF}}$) is self-refresh. Timing for self-refresh is quite similar to that for automatic refresh. As long as $\overline{\text{RAS}}$ remains high and $\overline{\text{REF}}$ remains low, the M5K4164AL will refresh itself. This internal sequence repeats asynchronously every 12 to 16 μs . After 2 ms, the on-chip refresh address counter has advanced through all the row addresses and refreshed the entire memory. Self-refresh is primarily intended for trouble free power-down operation.

For example, when battery backup is used to maintained data integrity in the memory, $\overline{\text{REF}}$ may be used to place the device in the self-refresh mode with no external timing signals necessary to keep the information alive.

In summary, the pin 5 ($\overline{\text{REF}}$) refresh function gives the user a feature that is free, save him hardware on the board, and in fact, will simplify his battery backup procedures, increase his battery life, and save him overall cost while giving him improved system performance.

There is an internal pullup resistor ($\approx 3M\Omega$) on pin 5, so if the pin 5 ($\overline{\text{REF}}$) function is not used, pin 5 may be left open (not connect) without affecting the normal operations.

5. Hidden Refresh

A feature of the M5K4164AL is that refresh cycles may be performed while maintaining valid data at the output pin by extending the $\overline{\text{CAS}}$ active time from a previous memory read cycle. This feature is referred to as hidden refresh.

Hidden refresh is performed by holding $\overline{\text{CAS}}$ at V_{IL} and taking $\overline{\text{RAS}}$ high and after a specified precharge period, executing a $\overline{\text{RAS}}$ -only cycling, automatic refresh and self-refresh, but with $\overline{\text{CAS}}$ held low.

The advantage of this refresh mode is that data can be held valid at the output data port indefinitely by leaving the $\overline{\text{CAS}}$ asserted. In many applications this eliminates the need for off-chip latches.

Power Dissipation

Most of the circuitry in the M5K4164AL is dynamic, and most of the power is dissipated when addresses are strobed. Both $\overline{\text{RAS}}$ and $\overline{\text{CAS}}$ are decoded and applied to the M5K4164AL as chip-select in the memory system, but if $\overline{\text{RAS}}$ is decoded, all unselected devices go into stand-by independent of the $\overline{\text{CAS}}$ condition, minimizing system power dissipation.

Power Supplies

The M5K4164AL operates on a single 5V power supply.

A wait of some 500 μs and eight or more dummy cycle is necessary after power is applied to the device before memory operation is achieved.

65 536-BIT (65 536-WORD BY 1-BIT) DYNAMIC RAM

ABSOLUTE MAXIMUM RATINGS

Symbol	Parameter	Conditions	Limits	Unit
V _{CC}	Supply voltage	With respect to V _{SS}	-1 ~ 7	V
V _I	Input voltage		-1 ~ 7	V
V _O	Output voltage		-1 ~ 7	V
I _O	Output current		50	mA
P _d	Power dissipation	T _a = 25°C	700	mW
T _{opr}	Operating free-air temperature range		0 ~ 70	°C
T _{stg}	Storage temperature range		-65 ~ 150	°C

RECOMMENDED OPERATING CONDITIONS (T_a = 0 ~ 70°C, unless otherwise noted) (Note 1)

Symbol	Parameter	Limits			Unit
		Min	Nom	Max	
V _{CC}	Supply voltage	4.5	5	5.5	V
V _{SS}	Supply voltage	0	0	0	V
V _{IH}	High-level input voltage, all inputs	2.4		6.5	V
V _{IL}	Low-level input voltage, all inputs	-2		0.8	V

Note 1 All voltage values are with respect to V_{SS}

ELECTRICAL CHARACTERISTICS (T_a = 0 ~ 70°C, V_{CC} = 5V ± 10%, V_{SS} = 0V, unless otherwise noted) (Note 2)

Symbol	Parameter	Test conditions	Limits			Unit	
			Min	Typ	Max		
V _{OH}	High-level output voltage	I _{OH} = -5mA	2.4		V _{CC}	V	
V _{OL}	Low-level output voltage	I _{OL} = 4.2mA	0		0.4	V	
I _{OZ}	Off-state output current	Q floating, 0V ≤ V _{OUT} ≤ 5.5V	-10		10	μA	
I _I	Input current	0V ≤ V _{IN} ≤ 6.5V, All other pins = 0V	-10		10	μA	
I _{CC1(AV)}	Average supply current from V _{CC} , operating (Note 3, 4)	M5K4164AL-12	R _{AS} , C _{AS} cycling		50	mA	
		M5K4164AL-15	t _{CR} = t _{OW} = min, output open		45	mA	
I _{CC2}	Supply current from V _{CC} , standby	R _{AS} = V _{IH} , output open			4	mA	
I _{CC3(AV)}	Average supply current from V _{CC} , refreshing (Note 3)	M5K4164AL-12	R _{AS} cycling, C _{AS} = V _{IH}		40	mA	
		M5K4164AL-15	t _{C(REF)} = min, output open		35	mA	
I _{CC4(AV)}	Average supply current from V _{CC} , page mode (Note 3, 4)	M5K4164AL-12	R _{AS} = V _{IL} , C _{AS} cycling		40	mA	
		M5K4164AL-15	t _{CPG} = min, output open		35	mA	
I _{CC5(AV)}	Average supply current from V _{CC} , automatic refreshing (Note 3)	M5K4164AL-12	R _{AS} = V _{IH} , R _{EF} cycling		40	mA	
		M5K4164AL-15	t _{C(REF)} = min, output open		35	mA	
I _{CC6(AV)}	Average supply current from V _{CC} , self refreshing	R _{AS} = V _{IH} , R _{EF} = V _{IL} , output open			8	mA	
C _{I(A)}	Input capacitance, address inputs	V _I = V _{SS} f = 1MHz V _I = 25mVrms			5	pF	
C _{I(D)}	Input capacitance, data input				5	pF	
C _{I(W)}	Input capacitance, write control input				7	pF	
C _{I(RAS)}	Input capacitance, R _{AS} input				10	pF	
C _{I(CAS)}	Input capacitance, C _{AS} input				10	pF	
C _{I(REF)}	Input capacitance, R _{EF} input				10	pF	
C _O	Output capacitance		V _O = V _{SS} , f = 1MHz, V _I = 25mVrms			7	pF

Note 2 Current flowing into an IC is positive, out is negative.

3 I_{CC1(AV)}, I_{CC3(AV)}, I_{CC4(AV)} and I_{CC5(AV)} are dependent on cycle rate. Maximum current is measured at the fastest cycle rate.

4 I_{CC1(AV)} and I_{CC4(AV)} are dependent on output loading. Specified values are obtained with the output open.

65 536-BIT (65 536-WORD BY 1-BIT) DYNAMIC RAM

TIMING REQUIREMENTS (For Read, Write, Read-Modify-Write, Refresh, and Page-Mode Cycle)

($T_a = 0 \sim 70^\circ\text{C}$, $V_{CC} = 5\text{V} \pm 10\%$, $V_{SS} = 0\text{V}$, unless otherwise noted, See notes 5, 6 and 7)

Symbol	Parameter	Alternative Symbol	M5K4164AL-12		M5K4164AL-15		Unit
			Limits		Limits		
			Min	Max	Min	Max	
t_{CRF}	Refresh cycle time	t_{REF}		2		2	ms
$t_W(\text{RAS})$	RAS high pulse width	t_{RP}	90		100		ns
$t_W(\text{RASL})$	RAS low pulse width	t_{RAS}	120	10000	150	10000	ns
$t_W(\text{CASL})$	CAS low pulse width	t_{CAS}	60	∞	75	∞	ns
$t_W(\text{CASH})$	CAS high pulse width (Note 8)	t_{CPN}	30		35		ns
$t_h(\text{RAS-CAS})$	CAS hold time after RAS	t_{CSH}	120		150		ns
$t_h(\text{CAS-RAS})$	RAS hold time after CAS	t_{RSH}	60		75		ns
$t_d(\text{CAS-RAS})$	Delay time, CAS to RAS (Note 9)	t_{CRP}	-20		-20		ns
$t_d(\text{RAS-CAS})$	Delay time, RAS to CAS (Note 10)	t_{RCD}	25	60	30	75	ns
$t_{SU}(\text{RA-RAS})$	Row address setup time before RAS	t_{ASR}	0		0		ns
$t_{SU}(\text{CA-CAS})$	Column address setup time before CAS	t_{ASC}	0		0		ns
$t_h(\text{RAS-RA})$	Row address hold time after RAS	t_{RAH}	15		20		ns
$t_h(\text{CAS-CA})$	Column address hold time after CAS	t_{CAH}	20		25		ns
$t_h(\text{RAS-CA})$	Column address hold time after RAS	t_{AR}	90		95		ns
t_{THL}	Transition time	t_T	3	35	3	50	ns
t_{TLH}							

- Note 5 An initial pause of 500 μ s is required after power-up followed by any eight REF, RAS or RAS/CAS cycles before proper device operation is achieved.
 Note 6 The switching characteristics are defined as $t_{THL} = t_{TLH} = 5\text{ns}$.
 Note 7 Reference levels of input signals are $V_{IH\text{ min}}$ and $V_{IL\text{ max}}$. Reference levels for transition time are also between V_{IH} and V_{IL} .
 Note 8 Except for page mode.
 Note 9 $t_d(\text{CAS-RAS})$ requirement is only applicable for RAS/CAS cycles preceded by a CAS only cycle (i.e., for systems where CAS has not been decoded with RAS).
 Note 10 Operation within the $t_d(\text{RAS-CAS})$ max limit insures that $t_a(\text{RAS})$ max can be met. $t_d(\text{RAS-CAS})$ max is specified reference point only, if $t_d(\text{RAS-CAS})$ is greater than the specified $t_d(\text{RAS-CAS})$ max limit, then access time is controlled exclusively by $t_a(\text{CAS})$.
 $t_d(\text{RAS-CAS})\text{ min} = t_h(\text{RAS-RA})\text{ min} + 2t_{THL}(t_{TLH}) + t_{SU}(\text{CA-CAS})\text{ min}$.

SWITCHING CHARACTERISTICS ($T_a = 0 \sim 70^\circ\text{C}$, $V_{CC} = 5\text{V} \pm 10\%$, $V_{SS} = 0\text{V}$, unless otherwise noted)

Read Cycle

Symbol	Parameter	Alternative Symbol	M5K4164AL-12		M5K4164AL-15		Unit
			Limits		Limits		
			Min	Max	Min	Max	
t_{CR}	Read cycle time	t_{RC}	220		260		ns
$t_{SU}(\text{R-CAS})$	Read setup time before CAS	t_{RCS}	0		0		ns
$t_h(\text{CAS-R})$	Read hold time after CAS (Note 11)	t_{RCH}	0		0		ns
$t_h(\text{RAS-R})$	Read hold time after RAS (Note 11)	t_{RRH}	10		20		ns
$t_{DIS}(\text{CAS})$	Output disable time (Note 12)	t_{OFF}	0	35	0	40	ns
$t_a(\text{CAS})$	CAS access time (Note 13)	t_{CAC}		60		75	ns
$t_a(\text{RAS})$	RAS access time (Note 14)	t_{RAC}		120		150	ns

- Note 11 Either $t_h(\text{RAS-R})$ or $t_h(\text{CAS-R})$ must be satisfied for a read cycle.
 Note 12 $t_{DIS}(\text{CAS})\text{ max}$ defines the time at which the output achieves the open circuit condition and is not reference to V_{OH} or V_{OL} .
 Note 13 This is the value when $t_d(\text{RAS-CAS}) \geq t_d(\text{RAS-CAS})\text{ max}$. Test conditions: Load = 2T TL, $C_L = 100\text{pF}$.
 Note 14 This is the value when $t_d(\text{RAS-CAS}) < t_d(\text{RAS-CAS})\text{ max}$. When $t_d(\text{RAS-CAS}) \geq t_d(\text{RAS-CAS})\text{ max}$, $t_a(\text{RAS})$ will increase by the amount that $t_d(\text{RAS-CAS})$ exceeds the value shown. Test conditions: Load = 2T TL, $C_L = 100\text{pF}$.

Write Cycle

Symbol	Parameter	Alternative Symbol	M5K4164AL-12		M5K4164AL-15		Unit
			Limits		Limits		
			Min	Max	Min	Max	
t_{CW}	Write cycle time	t_{RC}	220		260		ns
$t_{SU}(\text{W-CAS})$	Write setup time before CAS (Note 17)	t_{WCS}	-5		-5		ns
$t_h(\text{CAS-W})$	Write hold time after CAS	t_{WCH}	40		45		ns
$t_h(\text{RAS-W})$	Write hold time after RAS	t_{WCR}	90		95		ns
$t_h(\text{W-RAS})$	RAS hold time after write	t_{RWL}	40		45		ns
$t_h(\text{W-CAS})$	CAS hold time after write	t_{CWL}	40		45		ns
$t_W(\text{W})$	Write pulse width	t_{WP}	40		45		ns
$t_{SU}(\text{D-CAS})$	Data-in setup time before CAS	t_{DS}	0		0		ns
$t_h(\text{CAS-D})$	Data-in hold time after CAS	t_{DH}	40		45		ns
$t_h(\text{RAS-D})$	Data-in hold time after RAS	t_{DHR}	90		95		ns

65 536-BIT (65 536-WORD BY 1-BIT) DYNAMIC RAM

Read-Write and Read-Modify-Write Cycles

Symbol	Parameter	Alternative Symbol	M5K4164AL-12		M5K4164AL-15		Unit
			Limits		Limits		
			Min	Max	Min	Max	
t _{CRW}	Read-write cycle time (Note 15)	t _{RWC}	245		280		ns
t _{CRMW}	Read-modify-write cycle time (Note 16)	t _{RMWC}	265		310		ns
t _{h (W-RAS)}	RAS hold time after write	t _{RWL}	40		45		ns
t _{h (W-CAS)}	CAS hold time after write	t _{CWL}	40		45		ns
t _{w (W)}	Write pulse width	t _{WP}	40		45		ns
t _{SU (R-CAS)}	Read setup time before CAS	t _{RCS}	0		0		ns
t _{d (RAS-W)}	Delay time, RAS to write (Note 17)	t _{RWD}	100		120		ns
t _{d (CAS-W)}	Delay time, CAS to write (Note 17)	t _{CWD}	40		60		ns
t _{SU (D-W)}	Data-in setup time before write	t _{DS}	0		0		ns
t _{h (W-D)}	Data-in hold time after write	t _{DH}	40		45		ns
t _{dS (CAS)}	Output disable time	t _{OFF}	0	35	0	40	ns
t _{a (CAS)}	CAS access time (Note 13)	t _{CAC}		60		75	ns
t _{a (RAS)}	RAS access time (Note 14)	t _{RAC}		120		150	ns

Note 15: t_{CRW min} is defined as t_{CRW min} = t_{d (RAS-W)} + t_{h (W-RAS)} + t_{w (RASH)} + 3t_{TLH(t_{THL})}

16: t_{CRMW min} is defined as t_{CRMW min} = t_{a (RAS) max} + t_{h (W-RAS)} + t_{w (RASH)} + 3t_{TLH(t_{THL})}

17: t_{SU (W-CAS)}, t_{d (RAS-W)}, and t_{d (CAS-W)} do not define the limits of operation, but are included as electrical characteristics only.

When t_{SU (W-CAS)} ≥ t_{SU (W-CAS) min}, an early-write cycle is performed, and the data output keeps the high-impedance state.

When t_{d (RAS-W)} ≥ t_{d (RAS-W) min}, and t_{d (CAS-W)} ≥ t_{SU (W-CAS) min} a read-write cycle is performed, and the data of the selected address will be read out on the data output.

For all conditions other than those described above, the condition of data output (at access time and until CAS goes back to V_{IH}) is not defined.

Page-Mode Cycle

Symbol	Parameter	Alternative Symbol	M5K4164AL-12		M5K4164AL-15		Unit
			Limits		Limits		
			Min	Max	Min	Max	
t _{CPGR}	Page-mode read cycle time	t _{PC}	140		145		ns
t _{CPGW}	Page-Mode write cycle time	t _{PC}	140		145		ns
t _{CPGRW}	Page-Mode read-write cycle time	—	150		180		ns
t _{CPGRMW}	Page-Mode read-modify-write cycle time	—	170		195		ns
t _{w (CASH)}	CAS high pulse width	t _{CP}	55		60		ns

Automatic Refresh Cycle

Symbol	Parameter	Alternative Symbol	M5K4164AL-12		M5K4164AL-15		Unit
			Limits		Limits		
			Min	Max	Min	Max	
t _{C (REF)}	Automatic Refresh cycle time	t _{FC}	220		260		ns
t _{d (RAS-REF)}	Delay time, RAS to REF	t _{RFD}	90		100		ns
t _{w (REFL)}	REF low pulse width	t _{FP}	60	8000	60	8000	ns
t _{w (REFH)}	REF high pulse width	t _{FI}	30		30		ns
t _{d (REF-RAS)}	Delay time, REF to RAS	t _{FSR}	30		30		ns
t _{SU (REF-RAS)}	REF pulse setup time before RAS	t _{FRD}	250		295		ns

Self-Refresh Cycle

Symbol	Parameter	Alternative Symbol	M5K4164AL-12		M5K4164AL-15		Unit
			Limits		Limits		
			Min	Max	Min	Max	
t _{d (RAS-REF)}	Delay time, RAS to REF	t _{RFD}	90		100		ns
t _{w (REFL)}	REF low pulse width	t _{FBP}	8000	∞	8000	∞	ns
t _{d (REF-RAS)}	Delay time, REF to RAS	t _{FBR}	250		295		ns

65 536-BIT (65 536-WORD BY 1-BIT) DYNAMIC RAM

TIMING DIAGRAMS (Note 18)

Read Cycle (Note 19)

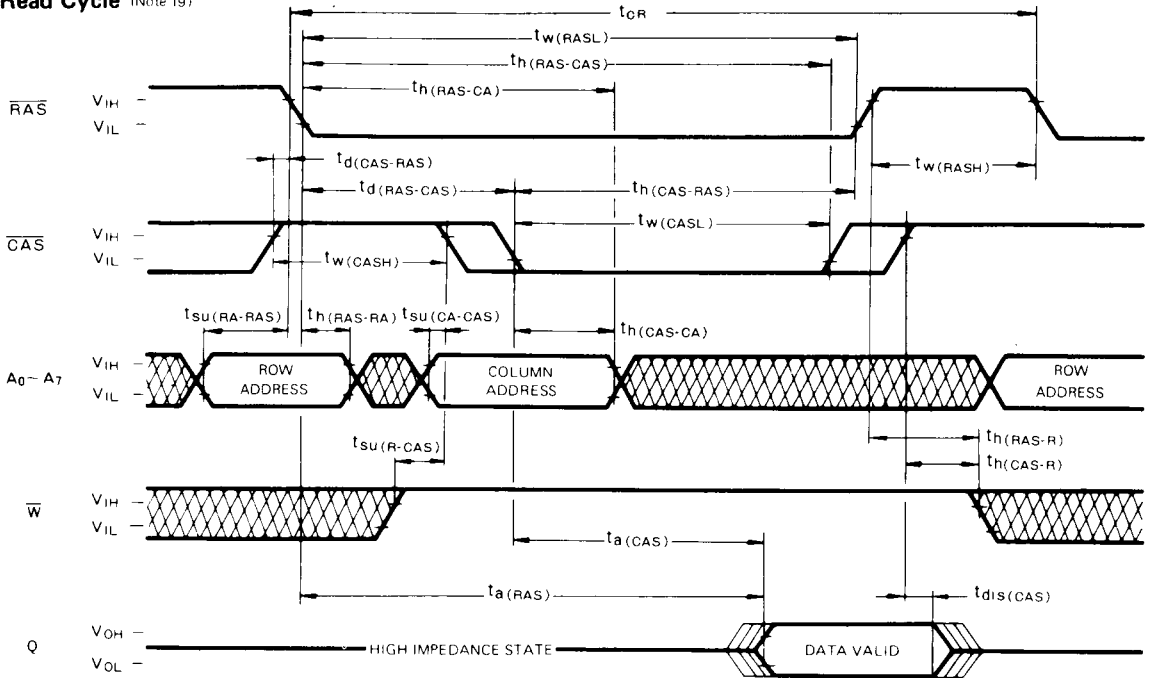

Write Cycle (Early Write) (Note 19)

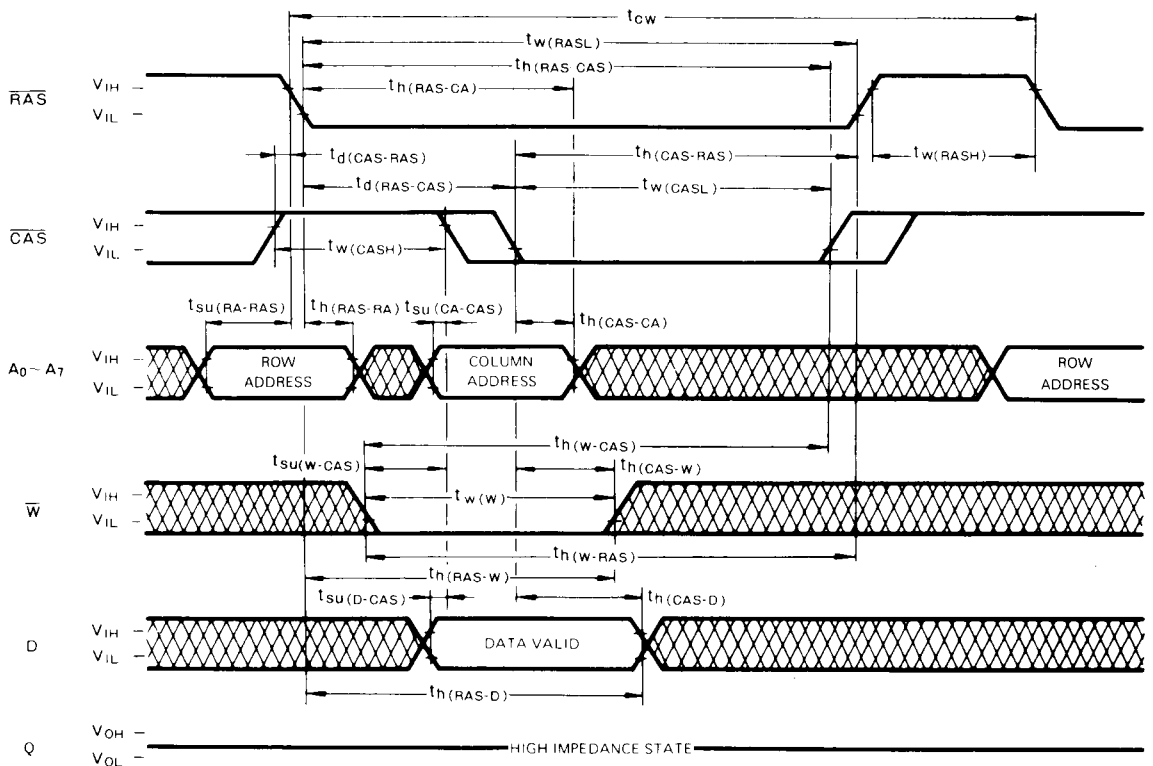

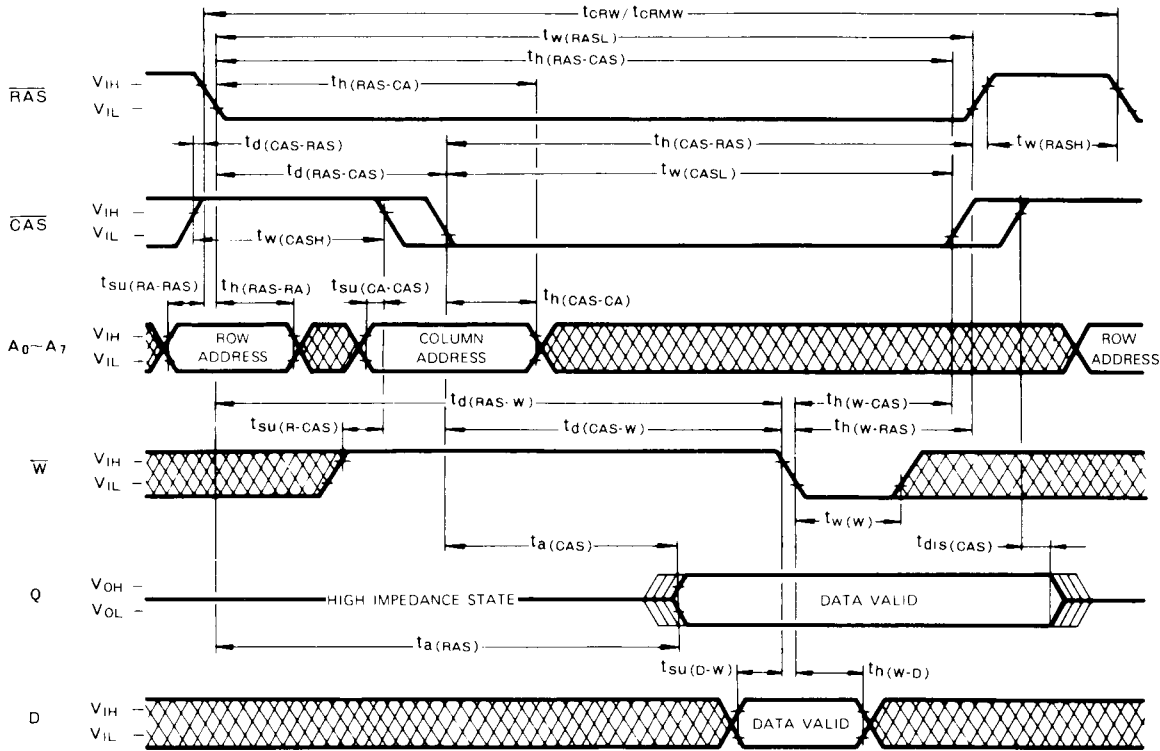

65 536-BIT (65 536-WORD BY 1-BIT) DYNAMIC RAM

Read-Write and Read-Modify-Write Cycles (Note 19)

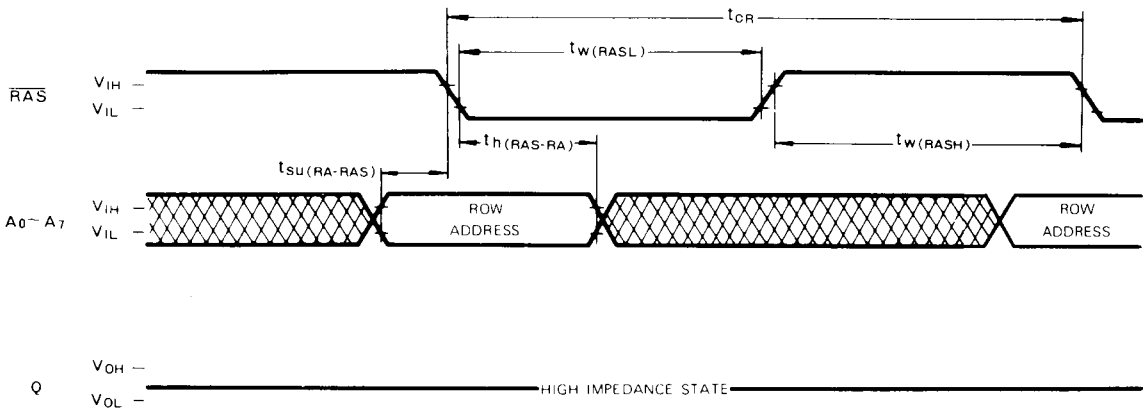

RAS-Only Refresh Cycle (Note 20)

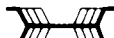

Note 18  Indicates the don't care input
 The center line indicates the high-impedance state

Note 19. REF = VIH
 20. CAS = REF = VIH, W, D = don't care.
 A7 may be VIH or VIL.

65 536-BIT (65 536-WORD BY 1-BIT) DYNAMIC RAM

Page-Mode Read Cycle (Note 19)

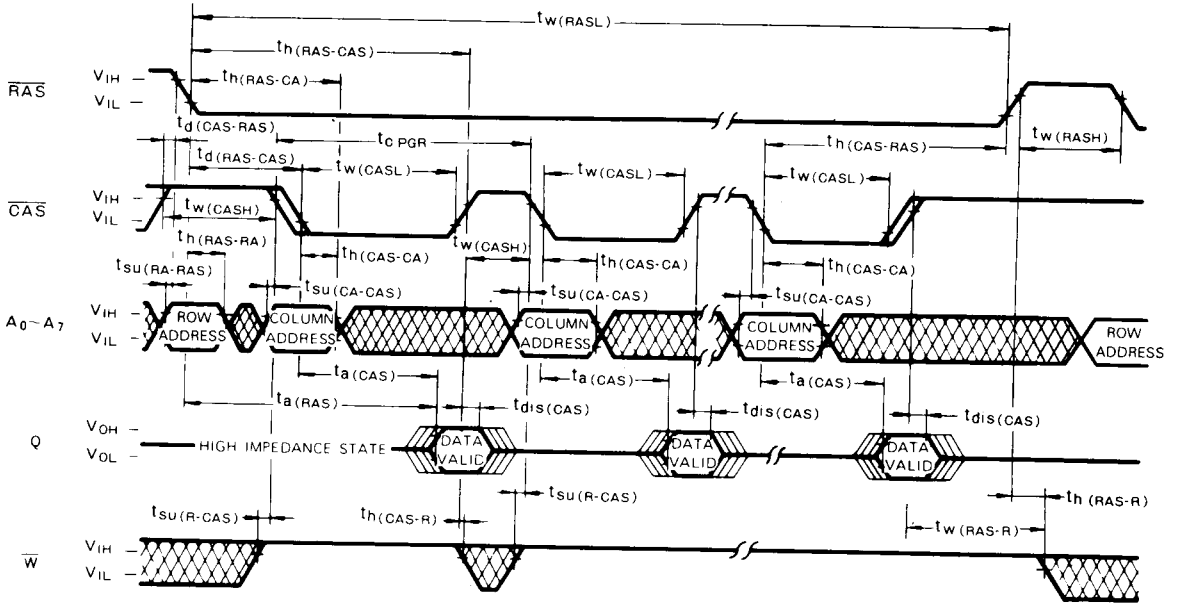

Page-Mode Write Cycle (Note 19)

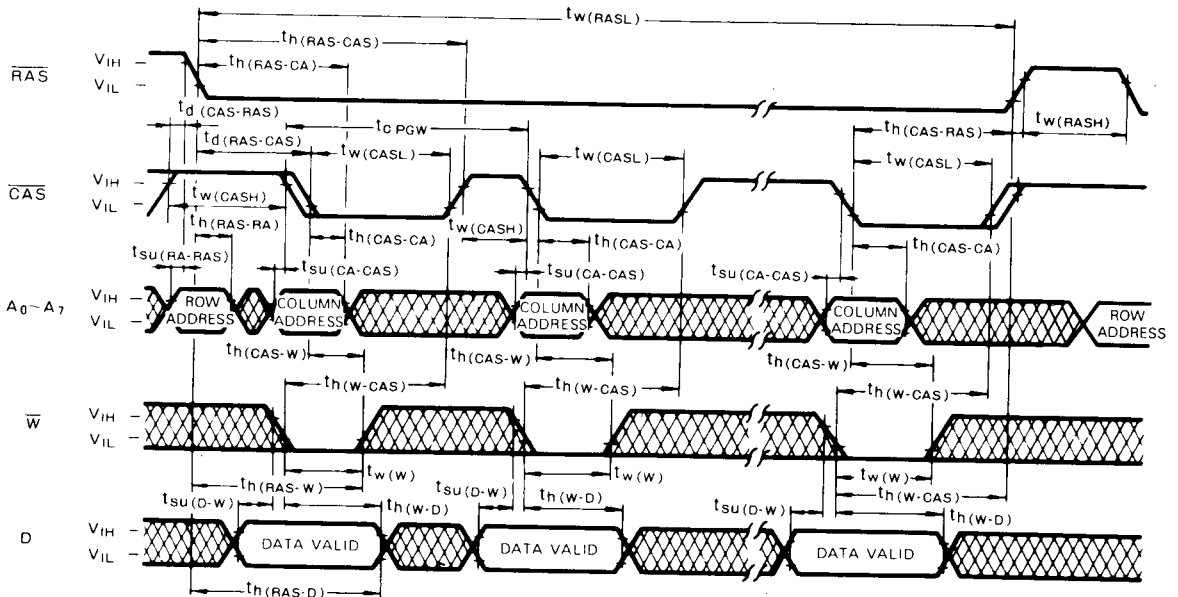

65 536-BIT (65 536-WORD BY 1-BIT) DYNAMIC RAM

Automatic Pulse Refresh Cycle (Multiple Pulse) (Note 21)

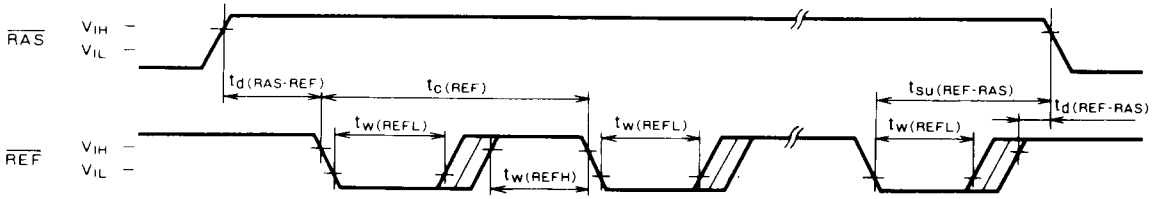

Automatic Pulse Refresh Cycle (Single Pulse) (Note 21)

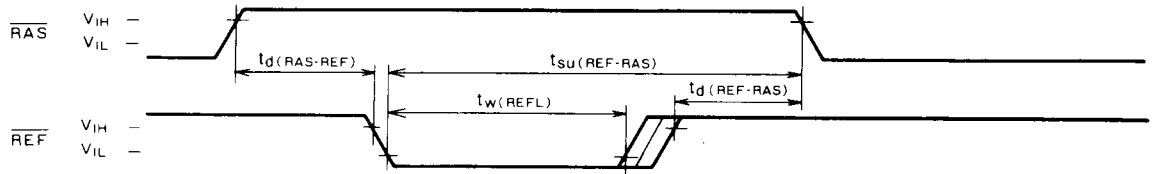

Self-Refresh Cycle (Note 21)

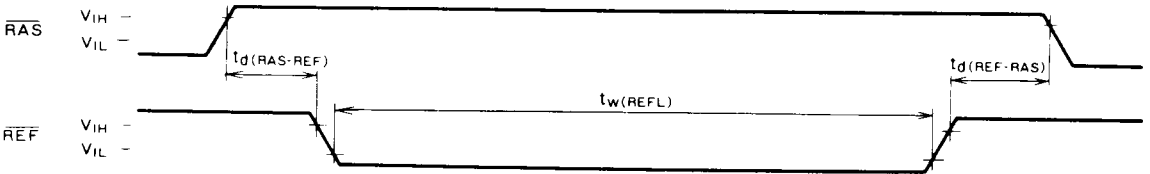

Note 21 $\overline{\text{CAS}}$, Addresses, D and $\overline{\text{W}}$ are don't care.

Hidden Automatic Pulse Refresh Cycle

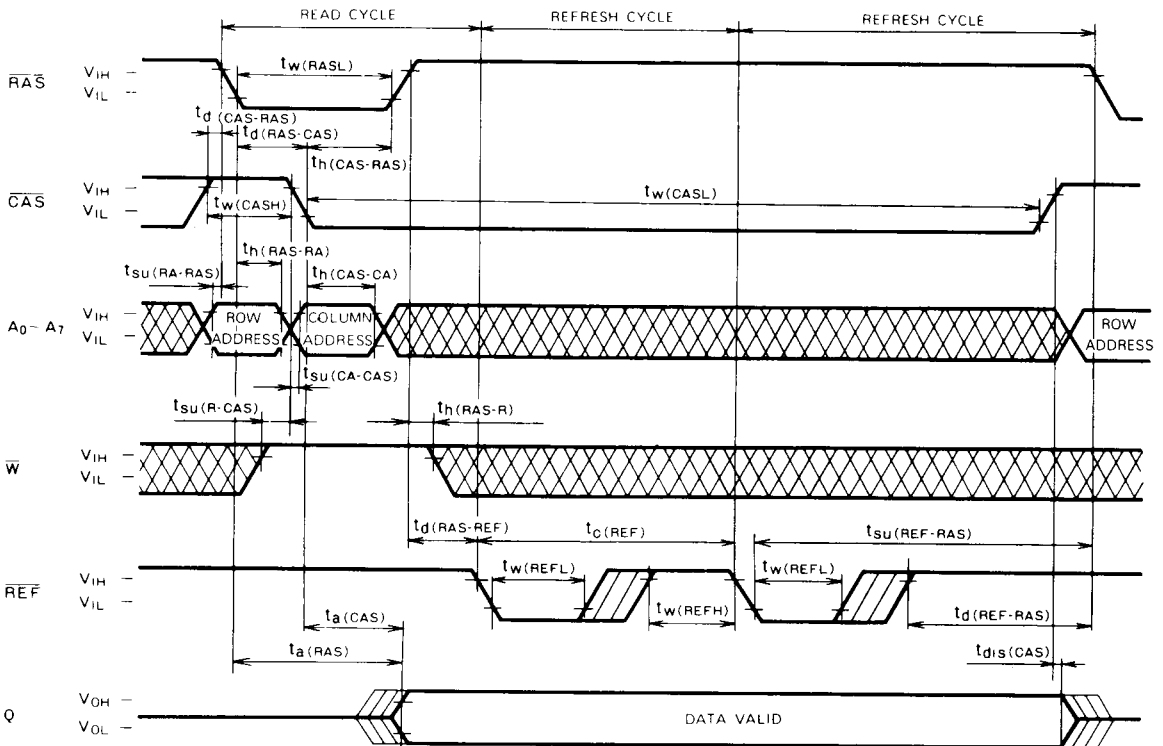

65 536-BIT (65 536-WORD BY 1-BIT) DYNAMIC RAM

Hidden Self-Refresh Cycle

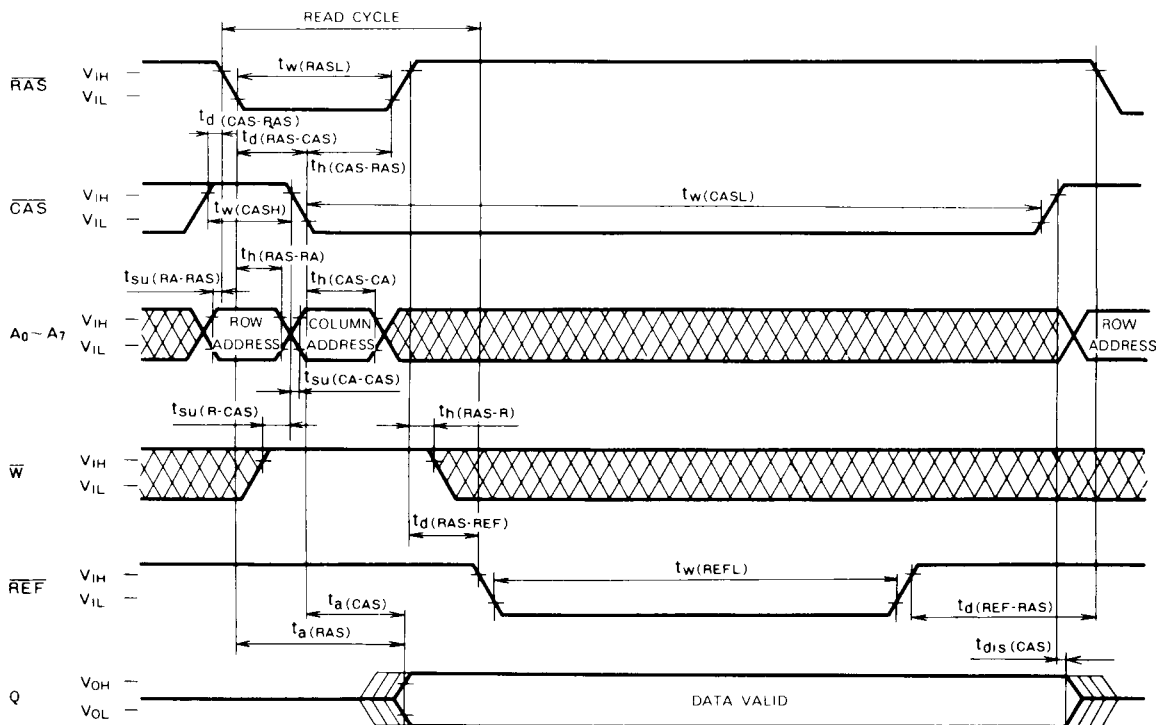

Note 22 If the pin 5 (\overline{REF}) function is not used, pin 5 may be left open (not connect).

Hidden Refresh Cycle (Note 19)

