

M5M417400CJ,TP-5,-6,-7,-5S,-6S,-7S

FAST PAGE MODE 16777216-BIT (4194304-WORD BY 4-BIT) DYNAMIC RAM

DESCRIPTION

This is a family of 4194304-word by 4-bit dynamic RAMS, fabricated with the high performance CMOS process, and is ideal for large-capacity memory systems where high speed, low power dissipation, and low costs are essential.

The use of double-layer metal process combined with twin-well CMOS technology and a single-transistor dynamic storage stacked capacitor cell provide high circuit density at reduced costs. Multiplexed address inputs permit both a reduction in pins and an increase in system densities.

FEATURES

Type Name	\overline{RAS} access time (max.ns)	\overline{CAS} access time (max.ns)	Address access time (max.ns)	\overline{OE} access time (max.ns)	Cycle time (min.ns)	Power dissipation (typ.mW)
M5M417400CXX-5,-5S	50	13	25	13	90	655
M5M417400CXX-6,-6S	60	15	30	15	110	540
M5M417400CXX-7,-7S	70	20	35	20	130	475

XX=J, TP

- Standard 26 pin SOJ, 26 pin TSOP
- Single 5V ± 10% supply
- Low stand-by power dissipation
 5.5mW(Max)CMOS Input level
 2.2mW (Max)*CMOS Input level
- Low operating power dissipation
 M5M417400Cxx-5,-5S 800.0mW (Max)
 M5M417400Cxx-6,-6S 660.0mW (Max)
 M5M417400Cxx-7,-7S 580.0mW (Max)
- Self refresh capability *
 self refresh current 200.0 μ A(Max)
- Fast-page mode, Read-modify-write, \overline{RAS} -only refresh
- \overline{CAS} before \overline{RAS} refresh, Hidden refresh capabilities
 Early-write mode and \overline{OE} to control output buffer impedance
- All inputs, output TTL compatible and low capacitance
- 2048 refresh cycles every 32ms ($A_0 \sim A_{10}$)
 *Applicable to self refresh version (M5M417400CJ,TP-5S,-6S,-7S :option) only

APPLICATION

Main memory unit for computers, Microcomputer memory, Refresh memory for CRT

PIN DESCRIPTION

Pin name	Function
$A_0 \sim A_{11}$	Address inputs
$DQ_1 \sim DQ_4$	Data inputs / outputs
RAS	Row address strobe input
CAS	Column address strobe input
\overline{W}	Write control input
\overline{OE}	Output enable input
V_{CC}	Power supply (+5V)
V_{SS}	Ground (0V)

PIN CONFIGURATION (TOP VIEW)

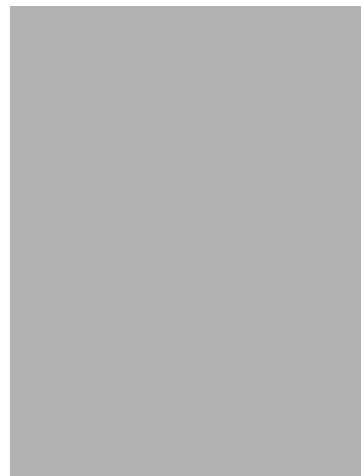

Outline 26P0D-B (300mil SOJ)

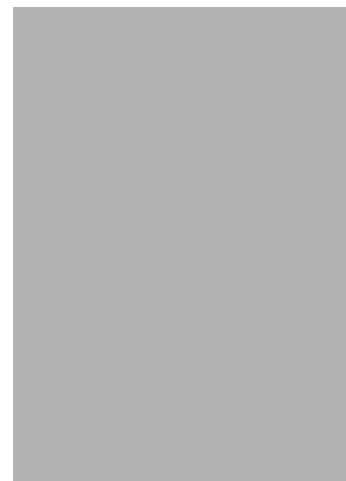

Outline 26P3D-E (300mil TSOP)

NC: NO CONNECTION

M5M417400CJ,TP-5,-6,-7,-5S,-6S,-7S

FAST PAGE MODE 16777216-BIT (4194304-WORD BY 4-BIT) DYNAMIC RAM

FUNCTION

The M5M417400CJ,TP provide, in addition to normal read, write, and read-modify-write operations, a number of other functions, e.g., fast page mode, $\overline{\text{RAS}}$ -only refresh, and delayed-write. The input conditions for each are shown in Table 1.

Table 1 Input conditions for each mode

Operation	Inputs						Input/Output		Refresh	Remark
	RAS	CAS	W	OE	Row address	Column address	Input	Output		
Read	ACT	ACT	NAC	ACT	APD	APD	OPN	VLD	YES	Fast page mode identical
Write (Early write)	ACT	ACT	ACT	DNC	APD	APD	VLD	OPN	YES	
Write (Delayed write)	ACT	ACT	ACT	DNC	APD	APD	VLD	IVD	YES	
Read-modify-write	ACT	ACT	ACT	ACT	APD	APD	VLD	VLD	YES	
$\overline{\text{RAS}}$ -only refresh	ACT	NAC	DNC	DNC	APD	DNC	DNC	OPN	YES	
Hidden refresh	ACT	ACT	NAC	ACT	APD	DNC	OPN	VLD	YES	
Self refresh	ACT	ACT	NAC	DNC	DNC	DNC	DNC	OPN	YES	
CAS before $\overline{\text{RAS}}$ refresh	ACT	ACT	NAC	DNC	DNC	DNC	DNC	OPN	YES	
Stand-by	NAC	DNC	DNC	DNC	DNC	DNC	DNC	OPN	NO	

Note: ACT: active, NAC: nonactive, DNC: don't care, VLD: valid, IVD: invalid, APD: applied, OPN: open

BLOCK DIAGRAM

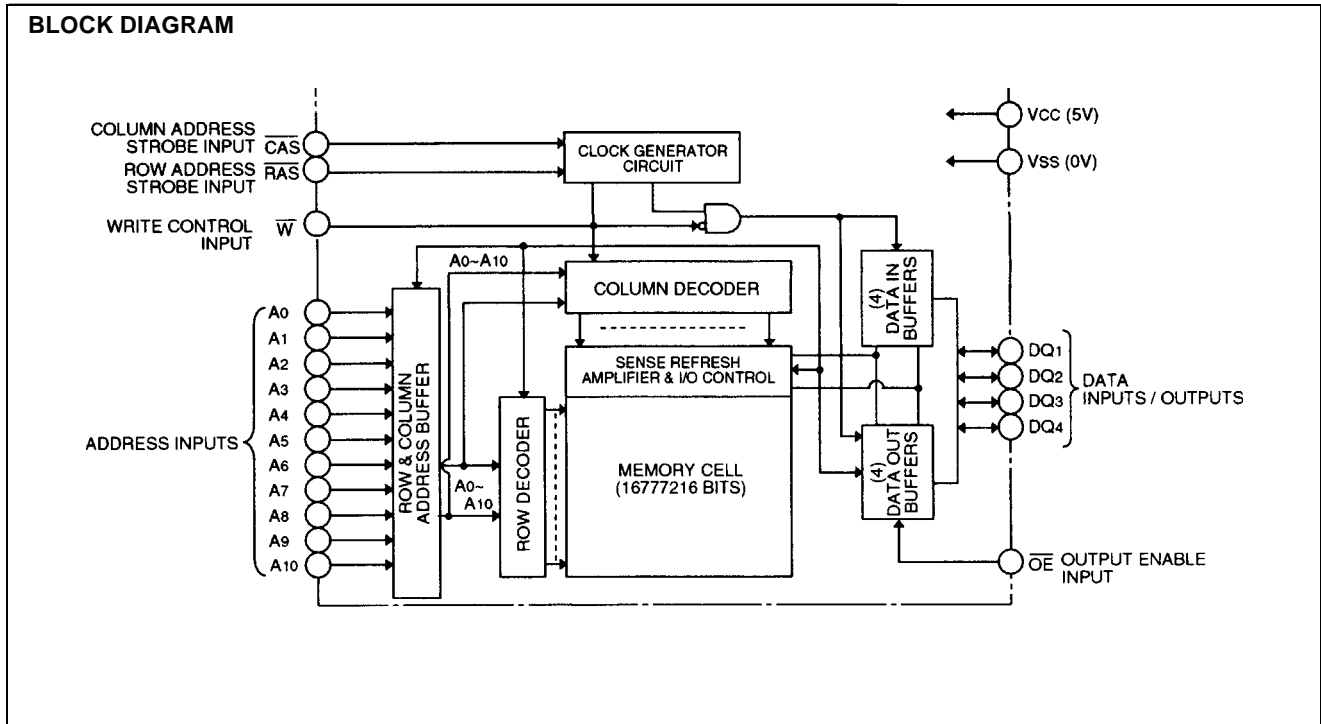

M5M417400CJ,TP-5,-6,-7,-5S,-6S,-7S

FAST PAGE MODE 16777216-BIT (4194304-WORD BY 4-BIT) DYNAMIC RAM

ABSOLUTE MAXIMUM RATINGS

Symbol	Parameter	Conditions	Ratings	Unit
V _{CC}	Supply voltage	With respect to V _{SS}	-1 ~ 7	V
V _I	Input voltage		-1 ~ 7	V
V _O	Output voltage		-1 ~ 7	V
I _O	Output current		50	mA
P _d	Power dissipation	T _a = 25°C	1000	mW
T _{opr}	Operating temperature		0 ~ 70	°C
T _{stg}	Storage temperature		-65 ~ 150	°C

RECOMMENDED OPERATING CONDITIONS

(T_a = 0 ~ 70°C, unless otherwise noted) (Note 1)

Symbol	Parameter	Limits			Unit
		Min	Nom	Max	
V _{CC}	Supply voltage	4.5	5	5.5	V
V _{SS}	Supply voltage	0	0	0	V
V _{IH}	High-level input voltage, all inputs	2.4		5.5	V
V _{IL}	Low-level input voltage, all inputs	-1.0**		0.8	V

Note 1: All voltage values are with respect to V_{SS}.

** : V_{IL(min.)} is -2.0V when undershoot width is less than 25ns. (Undershoot width is with respect to V_{SS}.)

ELECTRICAL CHARACTERISTICS

(T_a = 0 ~ 70°C, V_{CC} = 5V ± 10%, V_{SS} = 0V, unless otherwise noted) (Note 2)

Symbol	Parameter	Test conditions	Limits			Unit
			Min	Typ	Max	
V _{OH}	High-level output voltage	I _{OH} = -5.0mA	2.4		V _{CC}	V
V _{OL}	Low-level output voltage	I _{OL} = 4.2mA	0		0.4	V
I _{OZ}	Off-state output current	Q floating 0V ≤ V _{OUT} ≤ 5.5V	-10		10	μA
I _I	Input current	0V ≤ V _{IN} ≤ 5.5V, Other inputs pins = 0V	-10		10	μA
I _{CC1(AV)}	Average supply current from V _{CC} , operating (Note 3,4)	M5M417400C-5,-5S	R _{AS} , C _{AS} cycling t _{RC} = t _{WC} = min. output open		145	mA
		M5M417400C-6,-6S			120	
		M5M417400C-7,-7S			105	
I _{CC2}	Supply current from V _{CC} , stand-by (Note 5)	R _{AS} = C _{AS} = V _{IH} , output open			2	mA
		R _{AS} = C _{AS} ≥ V _{CC} - 0.2V			0.5	
I _{CC3(AV)}	Average supply current from V _{CC} , refreshing (Note 3)	M5M417400C-5,-5S	R _{AS} cycling, C _{AS} = V _{IH} t _{RC} = min. output open		145	mA
		M5M417400C-6,-6S			120	
		M5M417400C-7,-7S			105	
I _{CC4(AV)}	Average supply current from V _{CC} , Fast-Page-Mode (Note 3,4)	M5M417400C-5,-5S	R _{AS} = V _{IL} , C _{AS} cycling t _{PC} = min. output open		80	mA
		M5M417400C-6,-6S			70	
		M5M417400C-7,-7S			60	
I _{CC6(AV)}	Average supply current from V _{CC} , C _{AS} before R _{AS} refresh mode (Note 3)	M5M417400C-5,-5S	C _{AS} before R _{AS} refresh cycling t _{RC} = min. output open		145	mA
		M5M417400C-6,-6S			120	
		M5M417400C-7,-7S			105	

Note 2: Current flowing into an IC is positive, out is negative.

3: I_{CC1(AV)}, I_{CC3(AV)}, I_{CC4(AV)} and I_{CC6(AV)} are dependent on cycle rate. Maximum current is measured at the fastest cycle rate.

4: I_{CC1(AV)} and I_{CC4(AV)} are dependent on output loading. Specified values are obtained with the output open.

M5M417400CJ,TP-5,-6,-7,-5S,-6S,-7S

FAST PAGE MODE 16777216-BIT (4194304-WORD BY 4-BIT) DYNAMIC RAM

CAPACITANCE

(Ta = 0 ~ 70°C, V_{CC} = 5V ± 10%, V_{SS} = 0V, unless otherwise noted)

Symbol	Parameter	Test conditions	Limits			Unit
			Min	Typ	Max	
C _{I(A)}	Input capacitance, address inputs	V _I = V _{SS} f = 1MHz V _I = 25mVrms			5	pF
C _{I(OE)}	Input capacitance, \overline{OE} input				7	pF
C _{I(\overline{W})}	Input capacitance, write control input				7	pF
C _{I(\overline{RAS})}	Input capacitance, \overline{RAS} input				7	pF
C _{I(CAS)}	Input capacitance, CAS input				7	pF
C _{I/O}	Input/Output capacitance, data ports				8	pF

SWITCHING CHARACTERISTICS

(Ta = 0 ~ 70°C, V_{CC} = 5V ± 10%, V_{SS} = 0V, unless otherwise noted, see notes 5, 12, 13)

Symbol	Parameter	Limits						Unit
		M5M417400C-5,-5S		M5M417400C-6,-6S		M5M417400C-7,-7S		
		Min	Max	Min	Max	Min	Max	
t _{CAC}	Access time from \overline{CAS} (Note 6, 7)		13		15		20	ns
t _{RAC}	Access time from \overline{RAS} (Note 6, 8)		50		60		70	ns
t _{AA}	Column address access time (Note 6, 9)		25		30		35	ns
t _{CPA}	Access time from \overline{CAS} precharge (Note 6, 10)		30		35		40	ns
t _{OEa}	Access time from OE (Note 6)		13		15		20	ns
t _{CLZ}	Output low impedance time from \overline{CAS} low (Note 6)	5		5		5		ns
t _{OFF}	Output disable time after \overline{CAS} high (Note 11)	0	13	0	15	0	15	ns
t _{OEZ}	Output disable time after \overline{OE} high (Note 11)	0	13	0	15	0	15	ns

- Note 5: An initial pause of 500 μ s is required after power-up followed by a minimum of eight initialization \overline{RAS} cycles. The initialization cycles should be done either by \overline{RAS} -only refresh cycles or by \overline{CAS} before \overline{RAS} refresh cycles only.
 Note the \overline{RAS} may be cycled during the initial pause. And any 8 \overline{RAS} or $\overline{RAS}/\overline{CAS}$ cycles are required after prolonged periods (greater than 32ms) of \overline{RAS} inactivity before proper device operation is achieved.
 After the initialization cycles, \overline{RAS} should be kept either higher than V_{IH(min)} or lower than V_{IL(max)} except \overline{RAS} transition time.
- 6: Measured with a load circuit equivalent to 2 TTL loads and 100pF.
 7: Assumes that t_{RCD} ≥ t_{RCD(max)} and t_{ASC} ≥ t_{ASC(max)}.
 8: Assumes that t_{RCD} ≤ t_{RCD(max)} and t_{RAD} ≤ t_{RAD(max)}. If t_{RCD} or t_{RAD} is greater than the maximum recommended value shown in this table, t_{RAC} will increase by amount that t_{RCD} exceeds the value shown.
 9: Assumes that t_{RAD} ≥ t_{RAD(max)} and t_{ASC} ≤ t_{ASC(max)}.
 10: Assumes that t_{CP} ≤ t_{CP(max)} and t_{ASC} ≥ t_{ASC(max)}.
 11: t_{OFF(max)} and t_{OEZ(max)} defines the time at which the output achieves the high impedance state (I_{OUT} ≤ | ± 10 μ A |) and is not reference to V_{OH(min)} or V_{OL(max)}.

M5M417400CJ,TP-5,-6,-7,-5S,-6S,-7S

FAST PAGE MODE 1677216-BIT (4194304-WORD BY 4-BIT) DYNAMIC RAM

TIMING REQUIREMENTS (For Read, Write, Read-Modify-Write, Refresh, and Fast-Page Mode Cycles)

(Ta = 0 ~ 70°C, V_{CC} = 5V ± 10%, V_{SS} = 0V, unless otherwise noted. See notes 12, 13)

Symbol	Parameter	Limits						Unit
		M5M417400C-5,-5S		M5M417400C-6,-6S		M5M417400C-7,-7S		
		Min	Max	Min	Max	Min	Max	
t _{REF}	Refresh cycle time		32		32		32	ms
t _{RP}	\overline{RAS} high pulse width	30		40		50		ns
t _{RCD}	Delay time, \overline{RAS} low to \overline{CAS} low (Note 14)	18	37	20	45	20	50	ns
t _{CRP}	Delay time, \overline{CAS} high to \overline{RAS} low	10		10		10		ns
t _{RPC}	Delay time, RAS high to CAS low	0		0		0		ns
t _{CPN}	\overline{CAS} high pulse width	10		10		10		ns
t _{RAD}	Column address delay time from \overline{RAS} low (Note 15)	13	25	15	30	15	35	ns
t _{ASR}	Row address setup time before \overline{RAS} low	0		0		0		ns
t _{ASC}	Column address setup time before \overline{CAS} low (Note 16)	0	10	0	10	0	10	ns
t _{RAH}	Row address hold time after RAS low	8		10		10		ns
t _{CAH}	Column address hold time after \overline{CAS} low	13		15		15		ns
t _{DZC}	Delay time, data to \overline{CAS} low (Note 17)	0		0		0		ns
t _{DZO}	Delay time, data to \overline{OE} low (Note 17)	0		0		0		ns
t _{CDD}	Delay time, \overline{CAS} high to data (Note 18)	13		15		15		ns
t _{ODD}	Delay time, \overline{OE} high to data (Note 18)	13		15		15		ns
t _T	Transition time (Note 19)	1	50	1	50	1	50	ns

Note 12: The timing requirements are assumed t_T = 5ns.

13: V_{IH(min)} and V_{IL(max)} are reference levels for measuring timing of input signals.

14: t_{RCD(max)} is specified as a reference point only. If t_{RCD} is less than t_{RCD(max)}, access time is t_{RAC}. If t_{RCD} is greater than t_{RCD(max)}, access time is controlled exclusively by t_{CAC} or t_{AA}. t_{RCD(min)} is specified as t_{RAH(min)} + 2t_H + t_{ASC(min)}.

15: t_{RAD(max)} is specified as a reference point only. If t_{RAD} ≥ t_{RAD(max)} and t_{ASC} ≤ t_{ASC(max)}, access time is controlled exclusively by t_{AA}.

16: t_{ASC(max)} is specified as a reference point only. If t_{RCD} ≥ t_{RCD(max)} and t_{ASC} ≥ t_{ASC(max)}, access time is controlled exclusively by t_{CAC}.

17: Either t_{DZC} or t_{DZO} must be satisfied.

18: Either t_{CDD} or t_{ODD} must be satisfied.

19: t_T is measured between V_{IH(min)} and V_{IL(max)}.

Read and Refresh Cycles

Symbol	Parameter	Limits						Unit
		M5M417400C-5,-5S		M5M417400C-6,-6S		M5M417400C-7,-7S		
		Min	Max	Min	Max	Min	Max	
t _{RC}	Read cycle time	90		110		130		ns
t _{RAS}	\overline{RAS} low pulse width	50	10000	60	10000	70	10000	ns
t _{CAS}	\overline{CAS} low pulse width	13	10000	15	10000	20	10000	ns
t _{CSH}	\overline{CAS} hold time after \overline{RAS} low	50		60		70		ns
t _{RSH}	\overline{RAS} hold time after \overline{CAS} low	13		15		20		ns
t _{RCS}	Read setup time after \overline{CAS} high	0		0		0		ns
t _{RCH}	Read hold time after \overline{CAS} low (Note 20)	0		0		0		ns
t _{RRH}	Read hold time after \overline{RAS} low (Note 20)	10		10		10		ns
t _{RAL}	Column address to \overline{RAS} hold time	25		30		35		ns
t _{OCH}	\overline{CAS} hold time after \overline{OE} low	13		15		20		ns
t _{ORH}	\overline{RAS} hold time after \overline{OE} low	13		15		20		ns

Note 20: Either t_{RCH} or t_{RRH} must be satisfied for a read cycle.

M5M417400CJ,TP-5,-6,-7,-5S,-6S,-7S

FAST PAGE MODE 1677216-BIT (4194304-WORD BY 4-BIT) DYNAMIC RAM

Write Cycle (Early Write and Delayed Write)

Symbol	Parameter	Limits						Unit
		M5M417400C-5,-5S		M5M417400C-6,-6S		M5M417400C-7,-7S		
		Min	Max	Min	Max	Min	Max	
t _{WC}	Write cycle time	90		110		130		ns
t _{RAS}	\overline{RAS} low pulse width	50	10000	60	10000	70	10000	ns
t _{CAS}	\overline{CAS} low pulse width	13	10000	15	10000	20	10000	ns
t _{CSH}	\overline{CAS} hold time after \overline{RAS} low	50		60		70		ns
t _{RSH}	\overline{RAS} hold time after \overline{CAS} low	13		15		20		ns
t _{WCS}	Write setup time before \overline{CAS} low (Note 22)	0		0		0		ns
t _{WCH}	Write hold time after \overline{CAS} low	8		10		10		ns
t _{CWL}	\overline{CAS} hold time after \overline{W} low	13		15		20		ns
t _{RWL}	\overline{RAS} hold time after \overline{W} low	13		15		20		ns
t _{WP}	Write pulse width	8		10		10		ns
t _{DS}	Data setup time before \overline{CAS} low or \overline{W} low	0		0		0		ns
t _{DH}	Data hold time after \overline{CAS} low or \overline{W} low	8		10		15		ns
t _{OEH}	\overline{OE} hold time after \overline{W} low	13		15		20		ns

Read-Write and Read-Modify-Write Cycles

Symbol	Parameter	Limits						Unit
		M5M417400C-5,-5S		M5M417400C-6,-6S		M5M417400C-7,-7S		
		Min	Max	Min	Max	Min	Max	
t _{RWC}	Read write/read modify write cycle time (Note 21)	131		155		180		ns
t _{RAS}	\overline{RAS} low pulse width	91	10000	105	10000	120	10000	ns
t _{CAS}	\overline{CAS} low pulse width	54	10000	60	10000	70	10000	ns
t _{CSH}	\overline{CAS} hold time after \overline{RAS} low	91		105		120		ns
t _{RSH}	\overline{RAS} hold time after \overline{CAS} low	54		60		70		ns
t _{RCS}	Read setup time before \overline{CAS} low	0		0		0		ns
t _{CWD}	Delay time, \overline{CAS} low to \overline{W} low (Note 22)	36		40		45		ns
t _{RWD}	Delay time, \overline{RAS} low to \overline{W} low (Note 22)	73		85		95		ns
t _{AWD}	Delay time, address to \overline{W} low (Note 22)	48		55		60		ns
t _{CWL}	\overline{CAS} hold time after \overline{W} low	13		15		20		ns
t _{RWL}	\overline{RAS} hold time after \overline{W} low	13		15		20		ns
t _{WP}	Write pulse width	8		10		10		ns
t _{DS}	Data setup time before \overline{W} low	0		0		0		ns
t _{DH}	Data hold time after \overline{W} low	8		10		15		ns
t _{OEH}	\overline{OE} hold time after \overline{W} low	13		15		15		ns

Note 21: t_{RWC} is specified as t_{RWC(min)} = t_{RAC(max)} + t_{ODD(min)} + t_{RWL(min)} + t_{RP(min)} + 5t_r.

Note 22: t_{WCS}, t_{CWD}, t_{RWD} and t_{AWD} and t_{CPWD} are specified as reference points only. If t_{WCS} ≥ t_{WCS(min)} the cycle is an early write cycle and the DQ pins will remain high impedance throughout the entire cycle. If t_{CWD} ≥ t_{CWD(min)}, t_{RWD} ≥ t_{RWD(min)}, t_{AWD} ≥ t_{AWD(min)} and t_{CPWD} ≥ t_{CPWD(min)} (for fast page mode cycle only), the cycle is a read-modify-write cycle and the DQ will contain the data read from the selected address. If neither of the above condition (delayed write) of the DQ (at access time and until \overline{CAS} or \overline{OE} goes back to V_{IH}) is indeterminate.

M5M417400CJ,TP-5,-6,-7,-5S,-6S,-7S

FAST PAGE MODE 1677216-BIT (4194304-WORD BY 4-BIT) DYNAMIC RAM

Fast-Page Mode Cycle (Read, Early Write, Read-Write, Read-Modify-Write Cycle)

(Note 23)

Symbol	Parameter	Limits						Unit
		M5M417400C-5,-5S		M5M417400C-6,-6S		M5M417400C-7,-7S		
		Min	Max	Min	Max	Min	Max	
t _{PC}	Fast page mode read/write cycle time	35		40		45		ns
t _{PRWC}	Fast page mode read write/read modify write cycle time	76		85		95		ns
t _{RAS}	RAS low pulse width for read write cycle (Note 24)	85	125000	100	125000	115	125000	ns
t _{CP}	CAS high pulse width (Note 25)	8	12	10	15	10	15	ns
t _{CPRH}	RAS hold time after CAS precharge	30		35		40		ns
t _{CPWD}	Delay time, CAS precharge to W low (Note 22)	53		60		65		ns

Note 23: All previously specified timing requirements and switching characteristics are applicable to their respective fast page mode cycle.

24: t_{RAS(min)} is specified as two cycles of CAS input are performed.

25: t_{CP(max)} is specified as a reference point only.

CAS before RAS Refresh Cycle

(Note 26)

Symbol	Parameter	Limits						Unit
		M5M417400C-5,-5S		M5M417400C-6,-6S		M5M417400C-7,-7S		
		Min	Max	Min	Max	Min	Max	
t _{CSR}	CAS setup time before RAS low	10		10		10		ns
t _{CHR}	CAS hold time after RAS low	10		10		15		ns
t _{RSR}	Read setup time before RAS low	10		10		10		ns
t _{RHR}	Read hold time after RAS low	10		10		15		ns

Note 26: Eight or more CAS before RAS cycles instead of eight RAS cycles are necessary for proper operation of CAS before RAS refresh mode.

SELF REFRESH SPECIFICATIONS

Self refresh devices are denoted by "S" after speed item, like -5S/-6S/-7S. The other characteristics and requirements than the below are same as normal devices.

ELECTRICAL CHARACTERISTICS

(Ta = 0 ~ 70°C, V_{CC} = 5V ± 10%, V_{SS} = 0V, unless otherwise noted) (Note 2)

Symbol	Parameter	Test conditions	Limits			Unit
			Min	Typ	Max	
I _{CC8(AV)}	Average supply current from VCC Slow-Refresh cycle (Note 5)	M5M417400C (S) CAS before RAS refresh cycling or RAS cycling & CAS ≤ 0.2V OE & WE ≤ 0.2V or OE & WE ≥ V _{CC} - 0.2V A ₀ ~ A ₁₀ ≤ 0.2V or A ₀ ~ A ₁₀ ≥ V _{CC} - 0.2V t _{REF} = 128ms (2048 cycles) output = OPEN t _{RAS} = t _{RASmin} . ~ 1μs			500	μA
I _{CC9(AV)}	Average supply current from VCC Slow-Refresh cycle (Note 5)	M5M417400C (S) RAS = CAS ≤ 0.2V output = OPEN			200	μA

M5M417400CJ,TP-5,-6,-7,-5S,-6S,-7S

FAST PAGE MODE 16777216-BIT (4194304-WORD BY 4-BIT) DYNAMIC RAM

TIMING REQUIREMENTS

(Ta = 0 – 70°C, V_{CC} = 5V ± 10%, V_{SS} = 0V, unless otherwise noted, see notes 12, 13)

Symbol	Parameter	Limits						Unit
		M5M417400C-5S		M5M417400C-6S		M5M417400C-7S		
		Min	Max	Min	Max	Min	Max	
t _{RASS}	Self Refresh $\overline{\text{RAS}}$ low pulse width	100		100		100		μs
t _{RP5}	Self Refresh RAS high precharge time	90		110		130		ns
t _{CHS}	Self Refresh $\overline{\text{RAS}}$ hold time	-50		-50		-50		ns
t _{RSR}	Read setup time before $\overline{\text{RAS}}$ low	10		10		10		ns
t _{RHR}	Read hold time after $\overline{\text{RAS}}$ low	10		10		15		ns

SELF REFRESH ENTRY & EXIT CONDITIONS

1. In case of distributed refresh

The last / first full refresh cycles (2K) must be made within t_{NS} / t_{SN} before / after self refresh, on the condition of t_{NS} ≤ 32ms and t_{SN} ≤ 32ms.

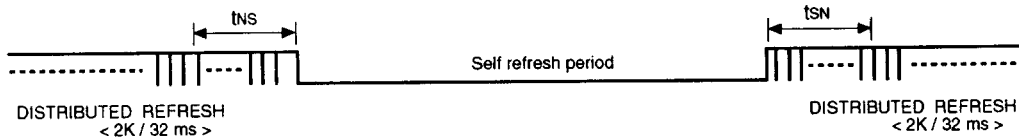

2. In case of burst refresh

The last / first full refresh cycles (2K) must be made within t_{NS} / t_{SN} before / after self refresh, on the condition of t_{NS} + t_{SN} ≤ 32ms.

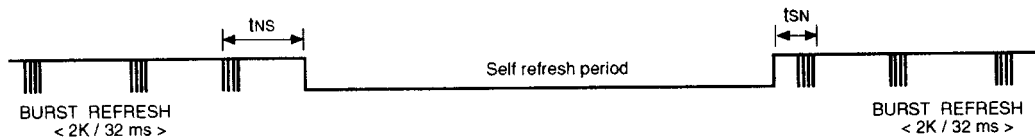

M5M417400CJ,TP-5,-6,-7,-5S,-6S,-7S

FAST PAGE MODE 16777216-BIT (4194304-WORD BY 4-BIT) DYNAMIC RAM

TEST Mode SET Cycle

Symbol	Parameter	Limits						Unit
		M5M417400C-5,-5S		M5M417400C-6,-6S		M5M417400C-7,-7S		
		Min	Max	Min	Max	Min	Max	
t_{WSR}	W setup time before RAS low	10		10		10		ns
t_{WHR}	\bar{W} hold time after \bar{RAS} low	10		10		15		ns

Note 27: The test mode function is initiated by a \bar{W} and CAS before \bar{RAS} cycle (WCBR cycle) as specified in timing diagram. The test mode function is terminated by either a \bar{CAS} before \bar{RAS} refresh cycle (CBR refresh cycle) or a \bar{RAS} only refresh cycle. During the test mode, the device is internally organized as 16-bits wide (1M bytes depth). No addressing of CA_0 and CA_1 is required. During a write cycle, data must be applied to all DQ (input) pins. The data can be different between DQ pins. The data on each DQ pin is written into 4-bits memory cells, respectively. During a read cycle, each DQ (output) pin shows the test result of the 4-bits, respectively. High state indicates that they are same. Low state indicates that they are not same. During the test mode operation, only WCBR cycle can be used to perform refresh.

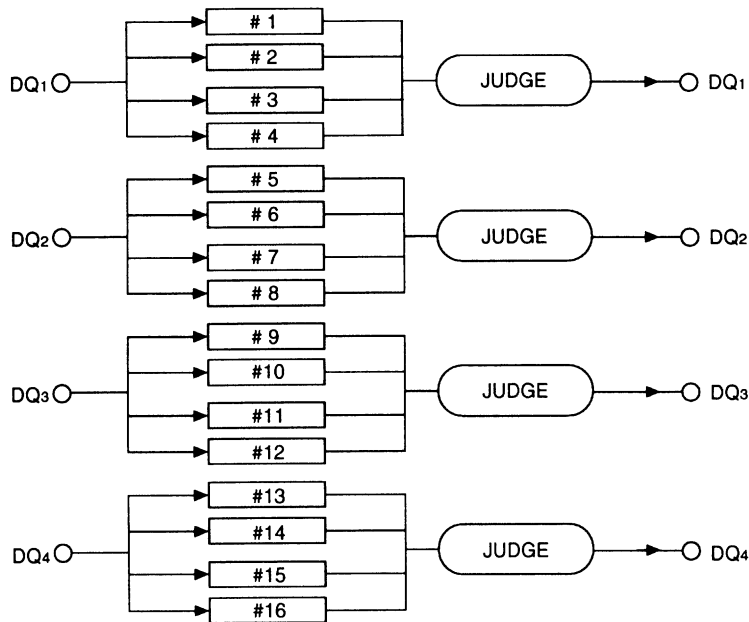

M5M417400CJ,TP-5,-6,-7,-5S,-6S,-7S

FAST PAGE MODE 1677216-BIT (4194304-WORD BY 4-BIT) DYNAMIC RAM

Timing Diagrams Read Cycle

(Note 28)

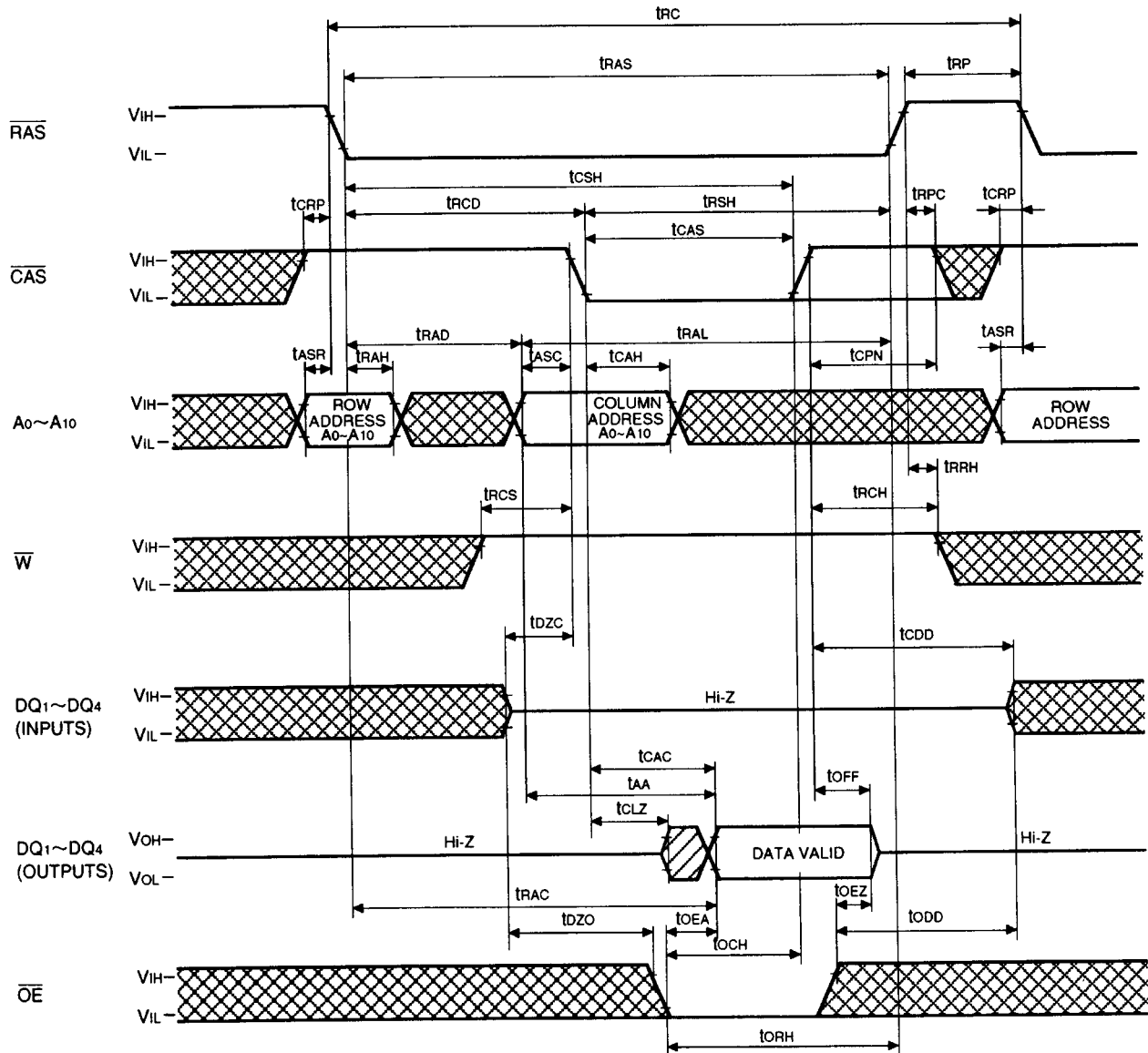

Note 28



Indicates the don't care input.
 $V_{IH(min)} \leq V_{IN} \leq V_{IH(max)}$ or $V_{IL(min)} \leq V_{IN} \leq V_{IL(max)}$



Indicates the invalid output.

M5M417400CJ,TP-5,-6,-7,-5S,-6S,-7S

FAST PAGE MODE 1677216-BIT (4194304-WORD BY 4-BIT) DYNAMIC RAM

Write Cycle (Early Write)

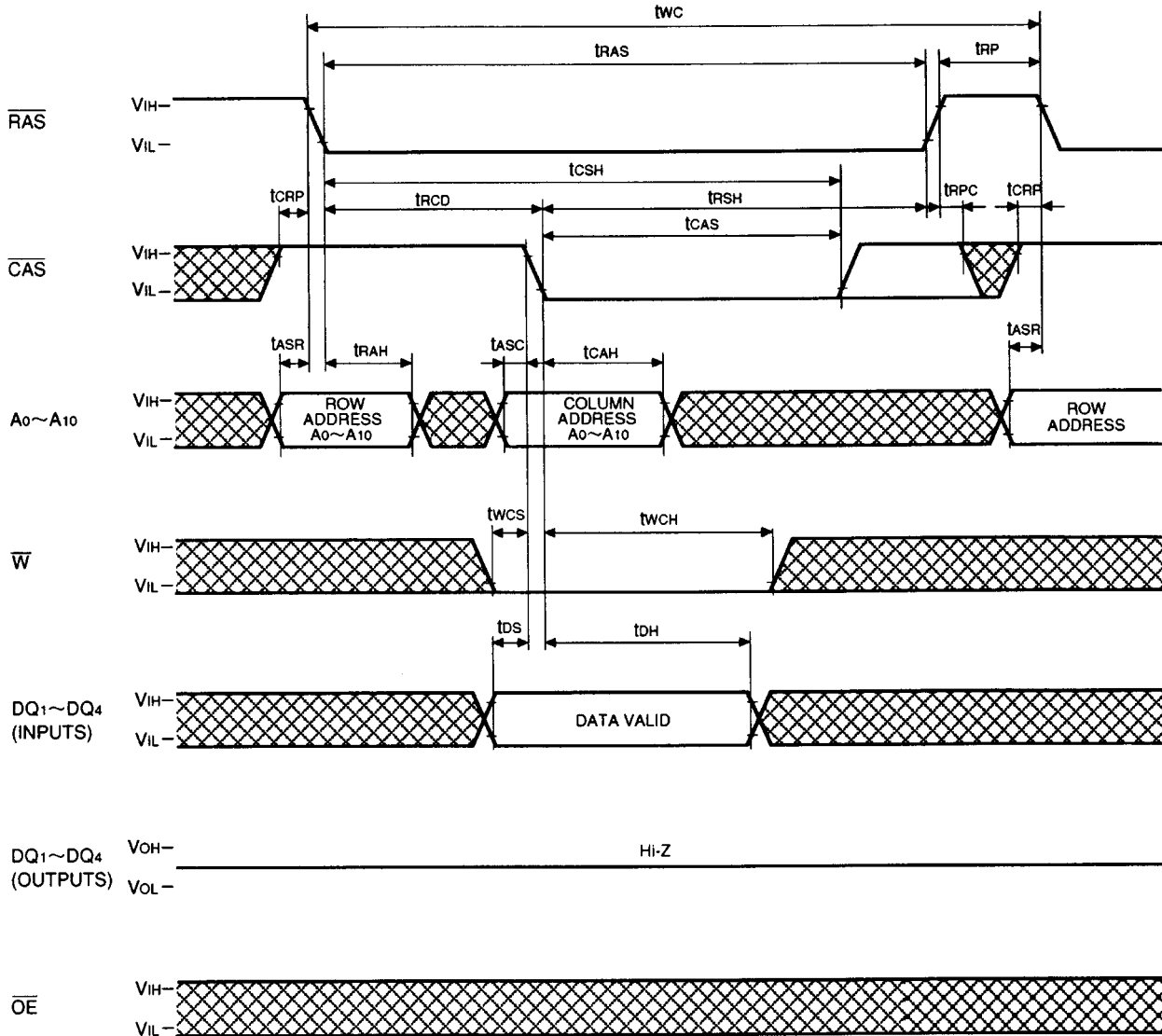

M5M417400CJ,TP-5,-6,-7,-5S,-6S,-7S

FAST PAGE MODE 16777216-BIT (4194304-WORD BY 4-BIT) DYNAMIC RAM

RAS-only Refresh Cycle

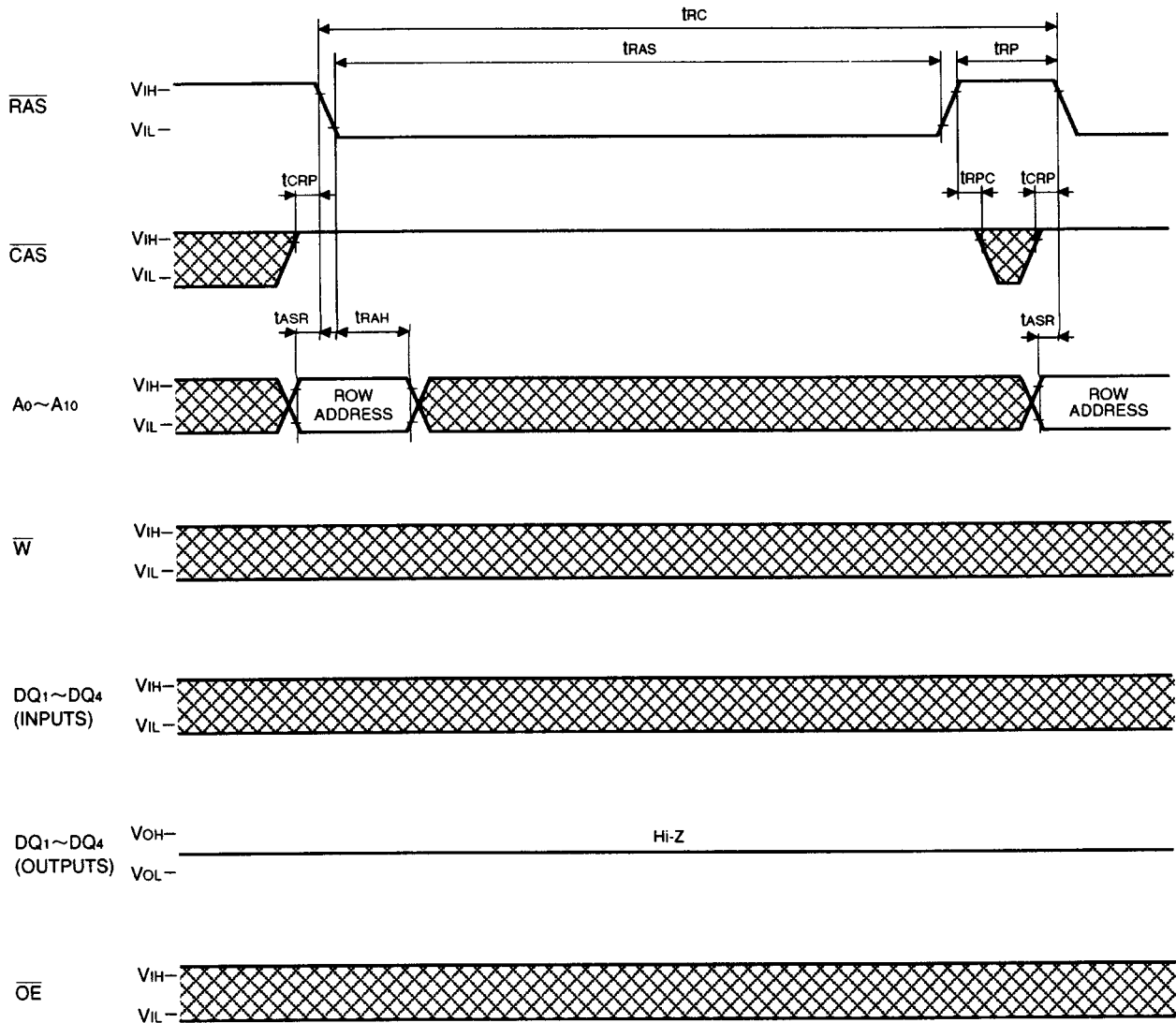

M5M417400CJ,TP-5,-6,-7,-5S,-6S,-7S

FAST PAGE MODE 16777216-BIT (4194304-WORD BY 4-BIT) DYNAMIC RAM

CAS before RAS Refresh Cycle, Slow Refresh Cycle

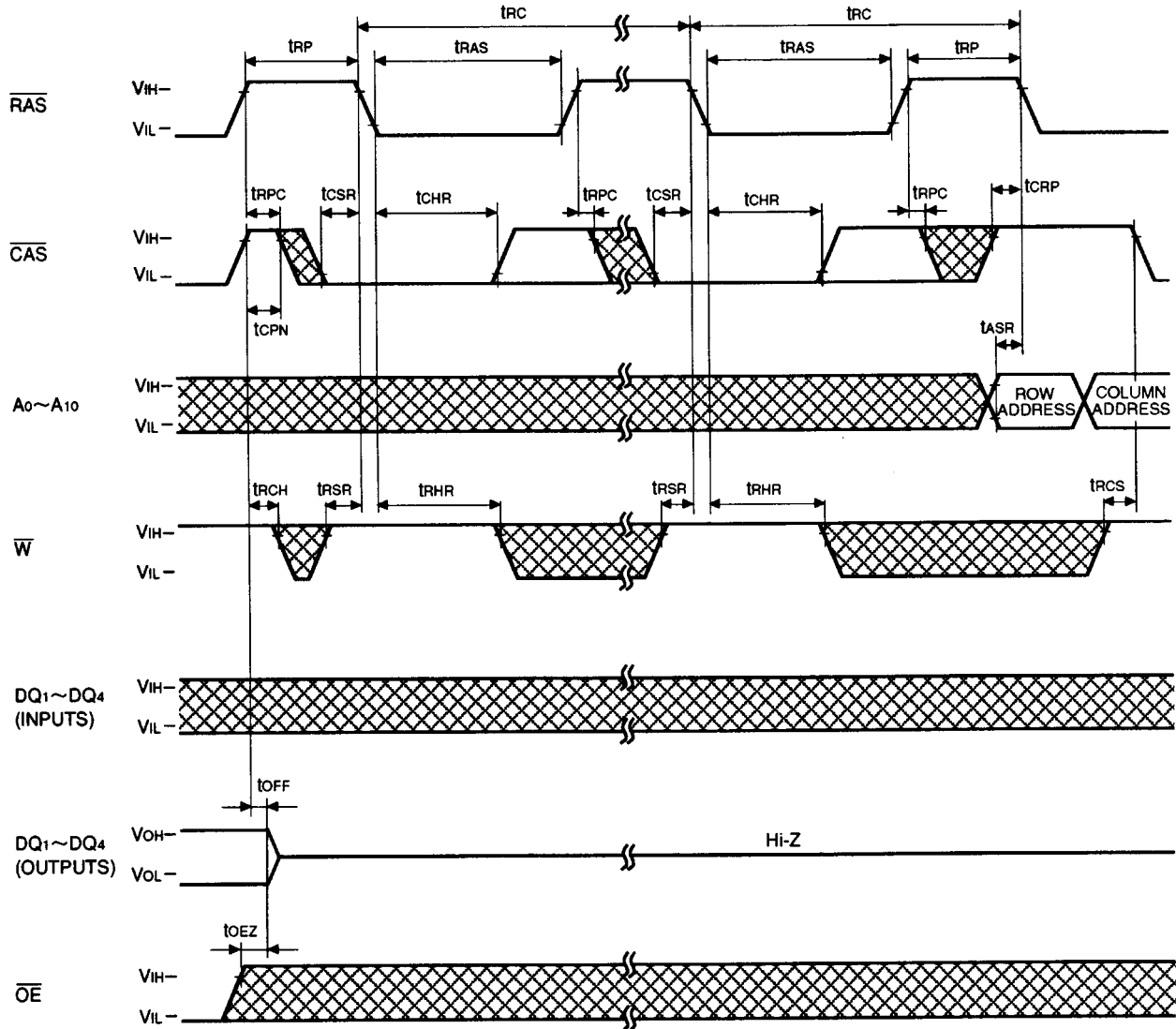

M5M417400CJ,TP-5,-6,-7,-5S,-6S,-7S

FAST PAGE MODE 1677216-BIT (4194304-WORD BY 4-BIT) DYNAMIC RAM

Hidden Refresh Cycle (Read)

(Note 29)

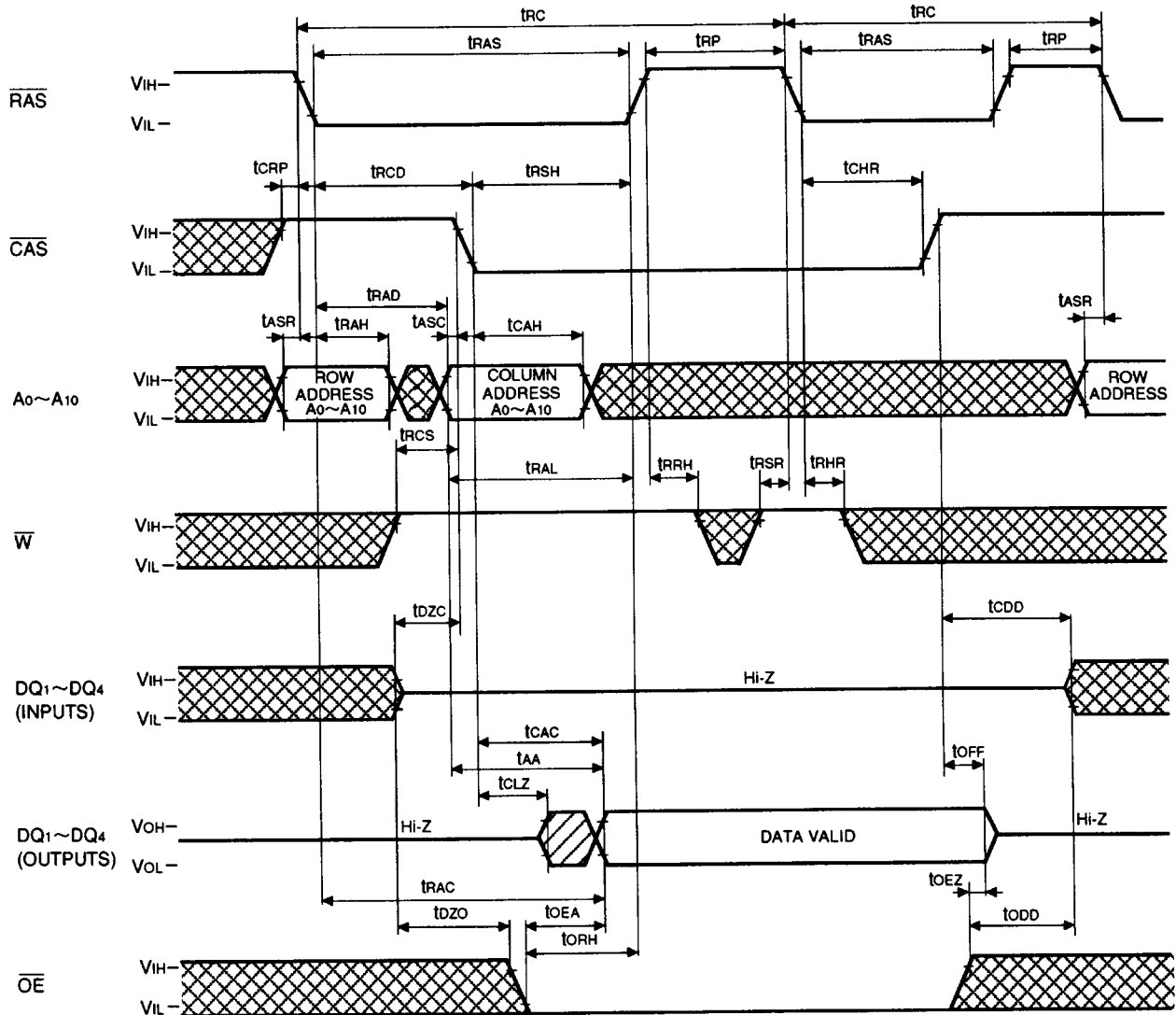

Note 29: Early write, delayed write, read write or read modify write cycle is applicable instead of read cycle.
 Timing requirements and output state are the same as that of each cycle shown above.
 And in any cycle, t_{RSR} & t_{RHR} should be satisfied not to enter TEST MODE.

M5M417400CJ,TP-5,-6,-7,-5S,-6S,-7S

FAST PAGE MODE 1677216-BIT (4194304-WORD BY 4-BIT) DYNAMIC RAM

Fast Page Mode Write Cycle (Early Write)

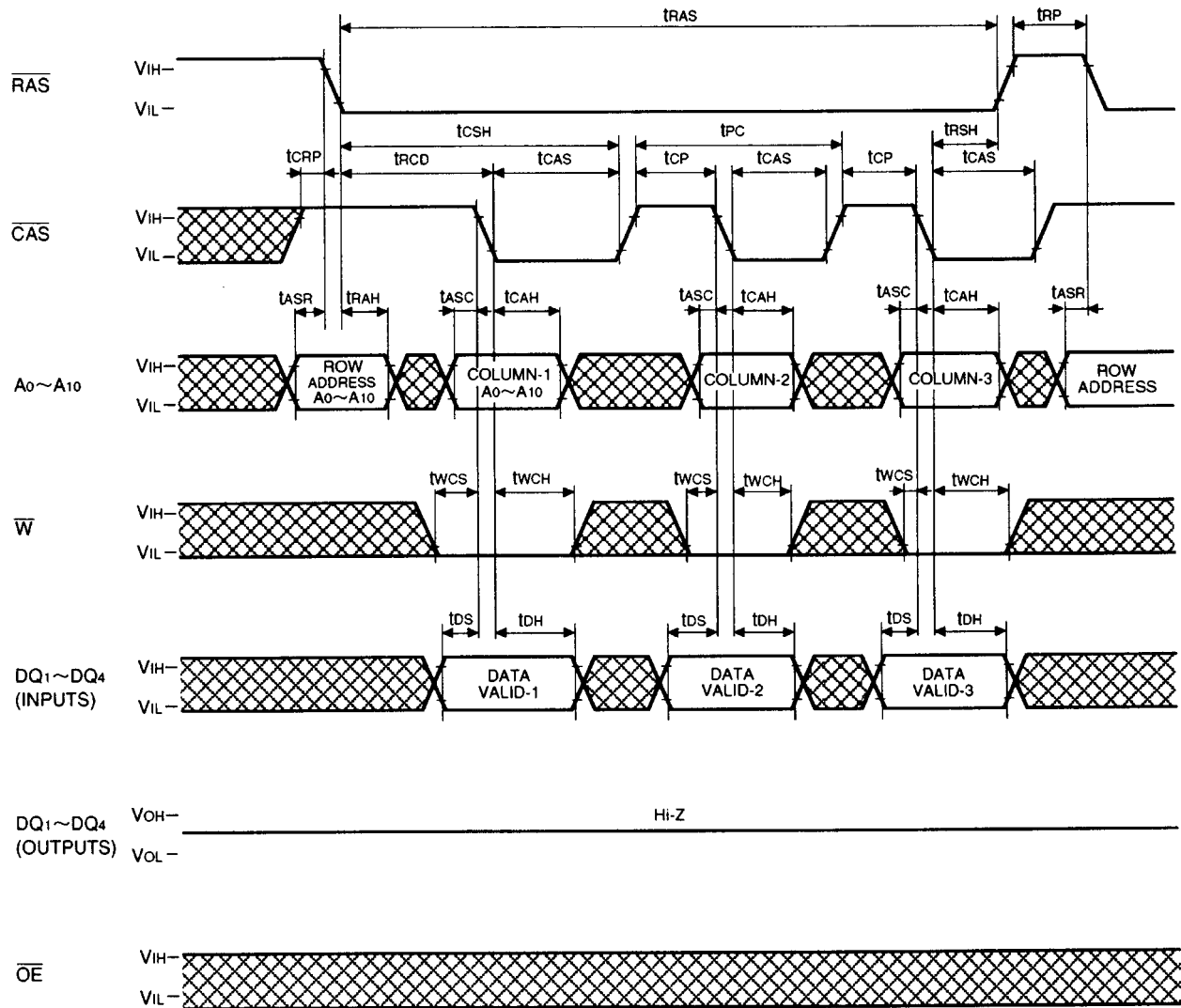

M5M417400CJ, TP-5, -6, -7, -5S, -6S, -7S

FAST PAGE MODE 1677216-BIT (4194304-WORD BY 4-BIT) DYNAMIC RAM

Fast Page Mode Read-Write, Read-Modify-Write Cycle

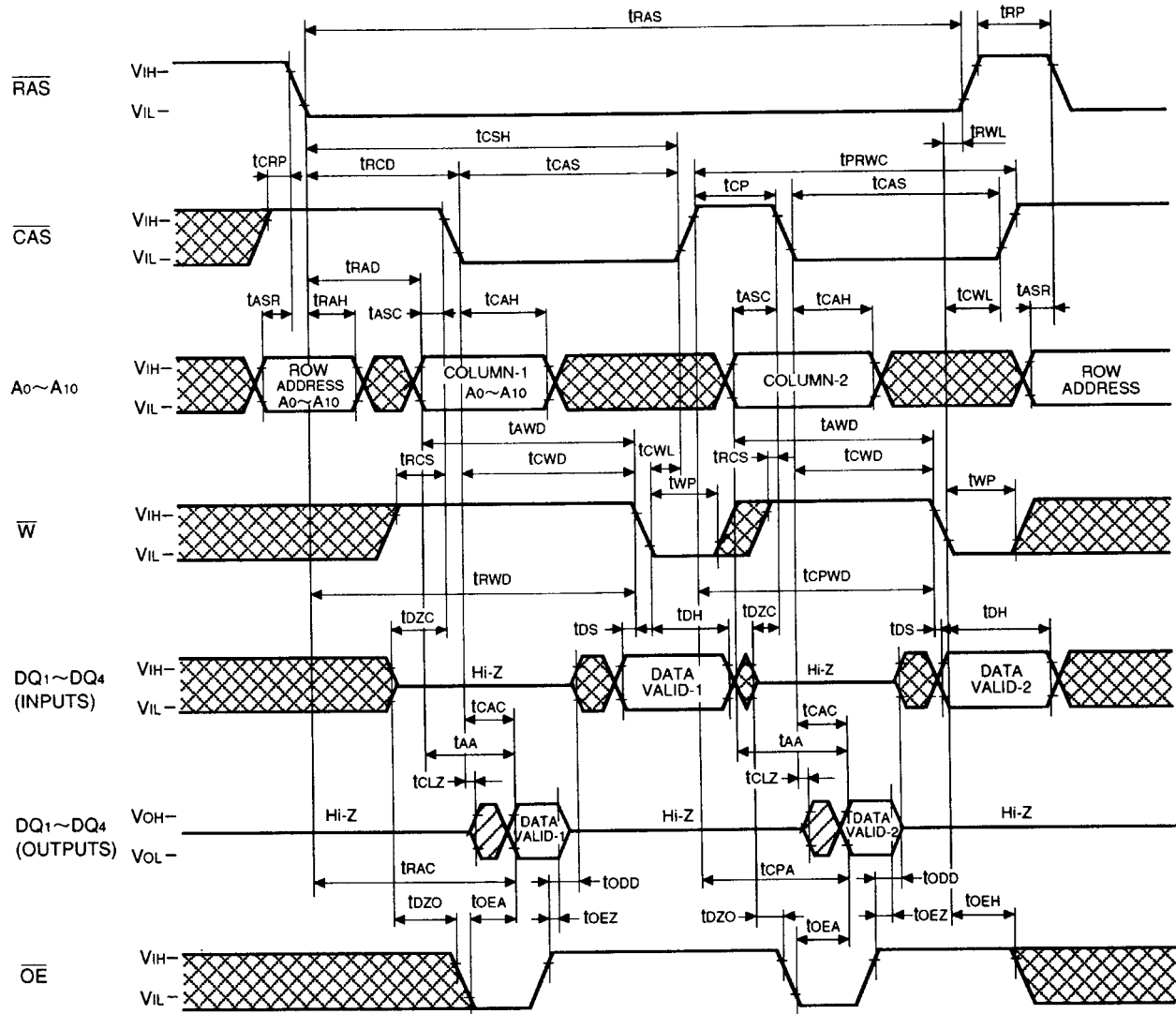

M5M417400CJ,TP-5,-6,-7,-5S,-6S,-7S

FAST PAGE MODE 16777216-BIT (4194304-WORD BY 4-BIT) DYNAMIC RAM

Self Refresh Cycle

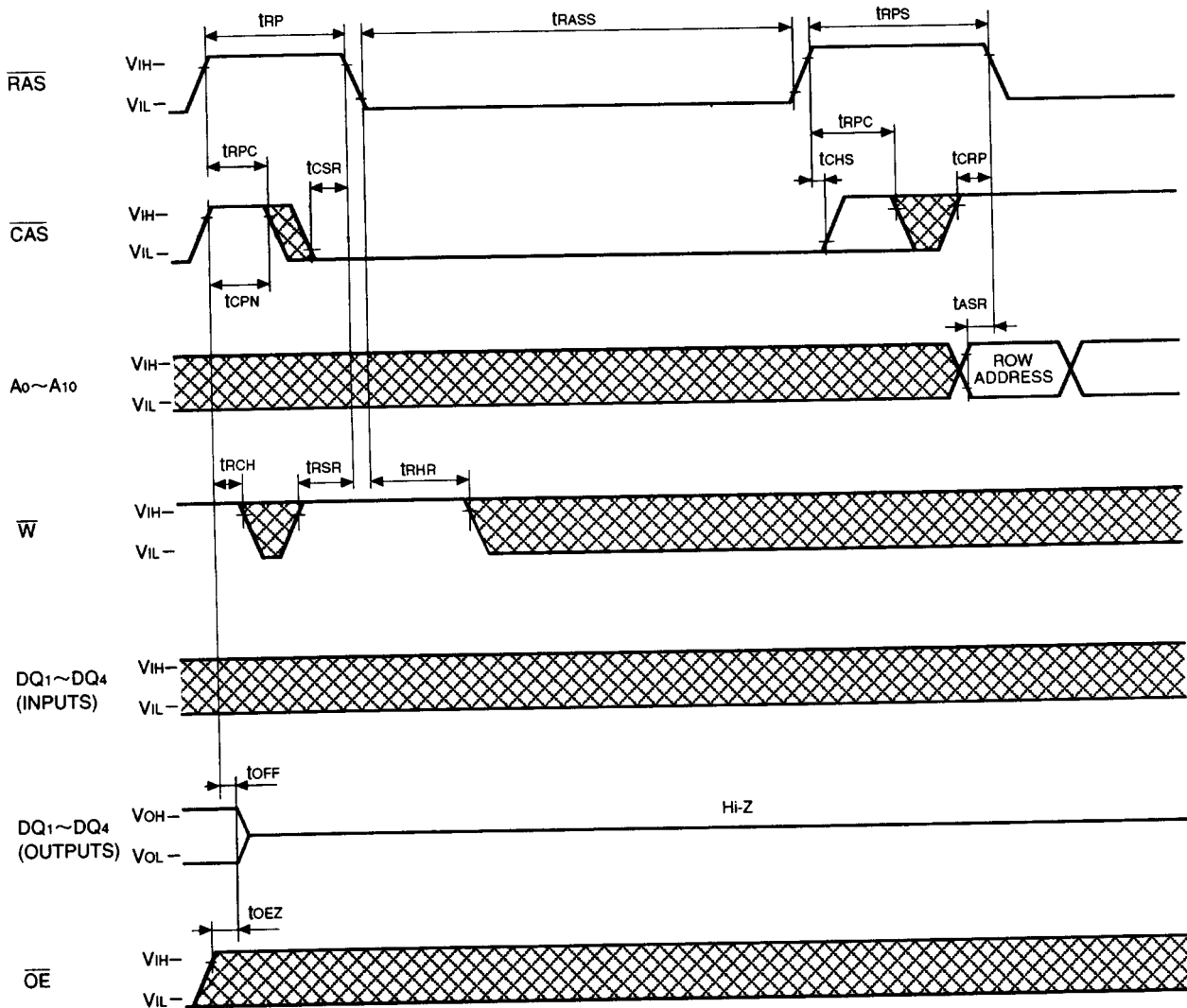

M5M417400CJ,TP-5,-6,-7,-5S,-6S,-7S

FAST PAGE MODE 1677216-BIT (4194304-WORD BY 4-BIT) DYNAMIC RAM

TEST Mode SET Cycle

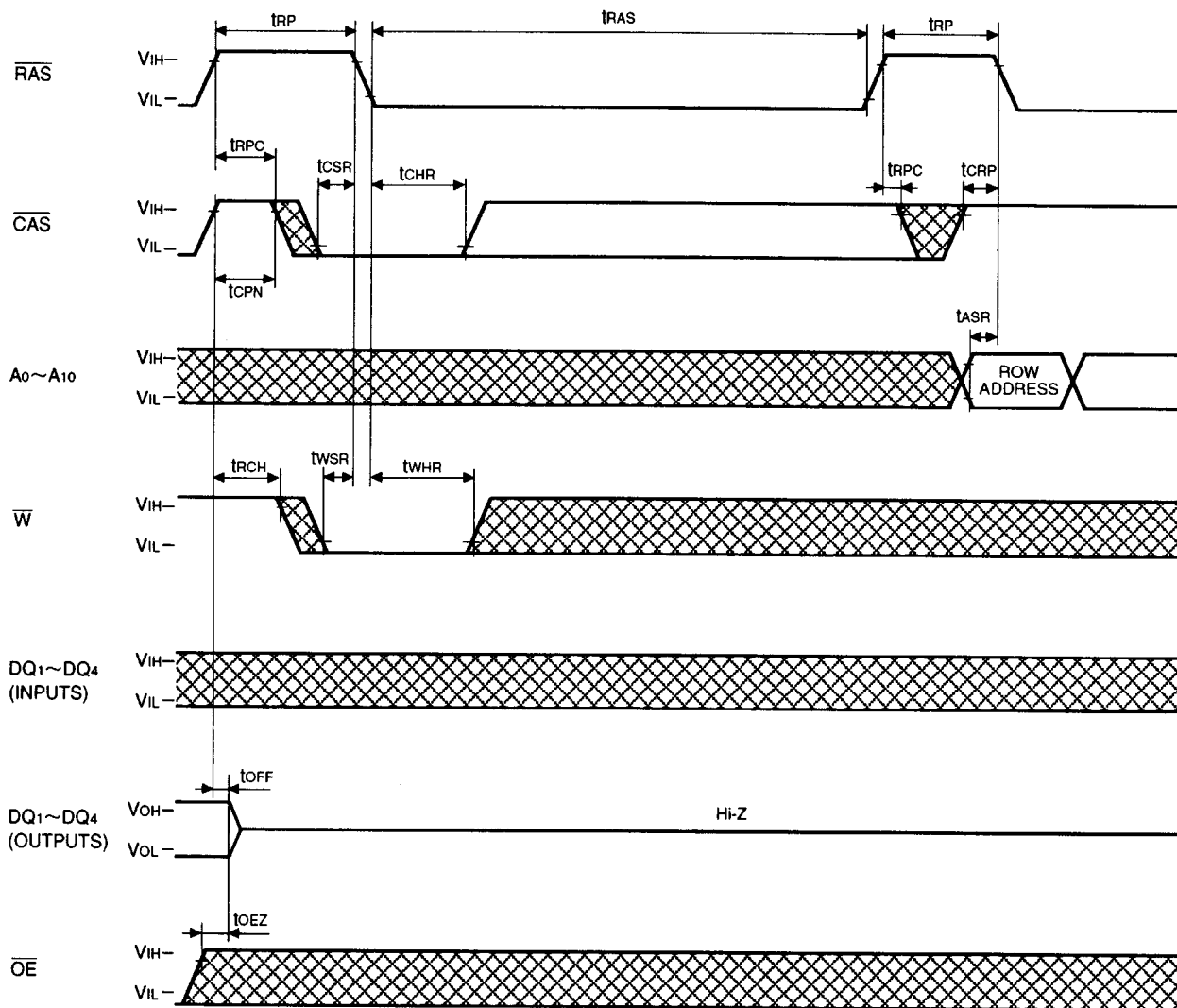

Note 30: This cycle can be used for initialized cycle after power-up, however entered into Test Mode.