



## GENERAL DESCRIPTION

The M635 Voltage Controlled Dielectric Resonator Oscillator (VCDRO) is specifically designed for high-speed SONET/SDH OC-192 applications and beyond. With an available center frequency range of 10 to 14GHz, and a tuning range of up to 40MHz, the VCDRO can be used in both OC-192 and OC-768 applications. The tuning range is  $\pm 1000$  ppm from center frequency.

The integrated Dielectric Resonator provides this VCO with low phase noise performance and excellent tuning linearity. The linear tuning range makes the M635 especially suited for phase-locked loop implementations, clock and data recovery circuits, and other timing applications for the telecom and optical fiber networking markets (OC-192/STM-64 with and without Forward Error Correction - FEC).

## FEATURES

- ◆ Voltage Controlled DRO center frequencies from 10 to 14 GHz (Specify center frequency at time of order)
- ◆ Low phase jitter 0.05ps rms typical (50kHz to 80MHz)
- ◆ Low phase noise -65dBc/Hz @ 1kHz offset
- ◆ Very linear and broad tuning range of 10 to 40MHz
- ◆ Ideal for high-speed fiber optic applications
- ◆ Single 5V power supply
- ◆ Small 1.25 x 1.5 inch SMA connector package

## BLOCK DIAGRAM

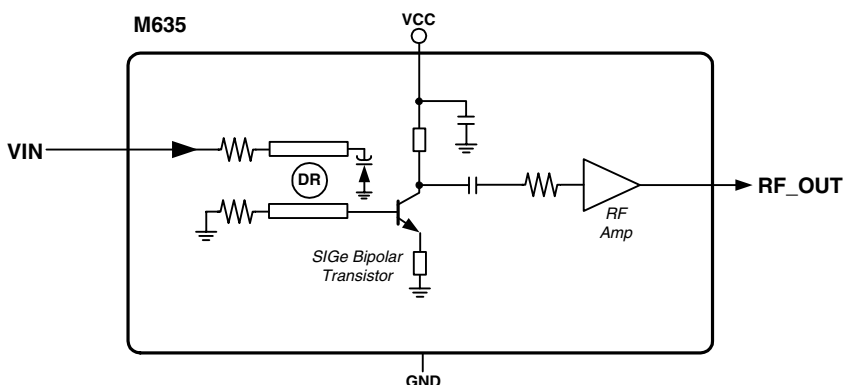

Figure 2: Block Diagram

## PIN ASSIGNMENT (1.25 x 1.5 inch SMA)

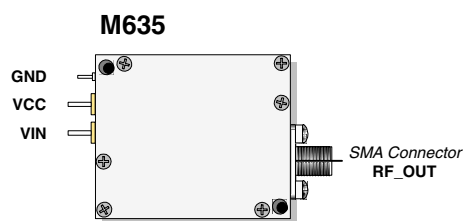

Figure 1: Pin Assignment

## Sample of Available Output Frequencies

VCDRO Center Frequency <sup>1</sup> (GHz)	Applications
10 GHz	OC-192
10.664 GHz	OC-192, OTU2 FEC
14 GHz	OC-192

Table 1: Sample of Available Output Frequencies

Note 1: Specify VCDRO center frequency at time of order



## PIN DESCRIPTIONS

Name	I/O	Description
GND	Ground	Power supply ground connections.
VCC	Power	Power supply connection, connect to +5.0V.
VIN	Input	Tuning Voltage
RF_OUT	Output	Clock output. SMA connector.

Table 2: Pin Descriptions

## ABSOLUTE MAXIMUM RATINGS<sup>1</sup>

Symbol	Parameter	Rating	Unit
V <sub>CC</sub>	Power Supply Voltage	5.25	V
T <sub>S</sub>	Storage Temperature	-40 to +125	°C

Table 3: Absolute Maximum Ratings

Note 1: Stresses beyond those listed under Absolute Maximum Ratings may cause permanent damage to the device. These ratings are stress specifications only. Functional operation of product at these conditions or any conditions beyond those listed in [Recommended Conditions of Operation](#), [DC Characteristics](#), or [AC Characteristics](#) is not implied. Exposure to absolute maximum rating conditions for extended periods may affect product reliability.

## RECOMMENDED CONDITIONS OF OPERATION

Symbol	Parameter	Min	Typ	Max	Unit
V <sub>CC</sub>	Positive Supply Voltage	4.75	5.0	5.25	V
T <sub>A</sub>	Ambient Operating Temperature	-40		+85	°C

Table 4: Recommended Conditions of Operation

## ELECTRICAL SPECIFICATIONS

### DC Characteristics

Unless stated otherwise, V<sub>CC</sub> = 5.0 Volts ±5%, T<sub>A</sub> = 25 °C, VCDDRO Frequency = 10-14GHz, Outputs terminated into 50Ω

	Symbol	Parameter	Min	Typ	Max	Unit
Power Supply	V <sub>CC</sub>	Positive Supply Voltage	4.75	5.0	5.25	V
	I <sub>CC</sub>	Power Supply Current			150	mA
Tuning		Tuning Port Impedance	2			kΩ
	V <sub>IN</sub>	Tuning Voltage	0		15	V

Table 5: DC Characteristics



## ELECTRICAL SPECIFICATIONS (CONTINUED)

### AC Characteristics

Unless stated otherwise,  $V_{CC} = 5.0 \text{ Volts} \pm 5\%$ ,  $T_A = 25^\circ\text{C}$ , VCDRO Frequency = 10-14GHz, Outputs terminated into  $50\Omega$

Symbol	Parameter	Min	Typ	Max	Unit
$F_{OUT}$	Output Center Frequency Range	10		14	GHz
	Temperature Stability		$\pm 300$		ppm
	Output Power	6			dBm
	Tuning Range	10	20	40	MHz
	Tuning Linearity		10		%
	VCO Gain KVCO		200		ppm/V
APR	Absolute Pull-Range	$\pm 1000$			ppm
	Non-harmonic Spurious			-60	dBc
	Harmonics			-25	dBc
$\Phi_n$	Single Side Band Phase Noise	1kHz Offset		-65	dBc/Hz
		10kHz Offset		-90	dBc/Hz
		100kHz Offset		-110	dBc/Hz
J(t)	Jitter (rms)	50kHz to 80MHz		0.05	ps
	Load VSWR (Voltage Standing Wave Ratio)			1.5:1	

Table 6: AC Characteristics

## TEST DATA

### Phase Noise:

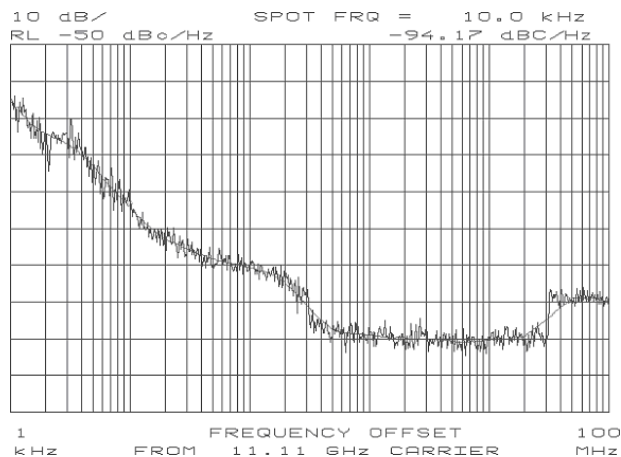

Figure 3: Phase Noise

### Frequency Tuning Characteristics

Frequency Offset (ppm) vs. Tuning Voltage (V)

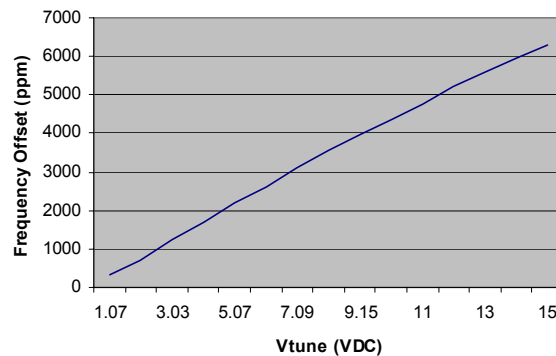

Figure 4: Frequency Tuning Characteristics



## TEST DATA (CONTINUED)

### Typical Temperature Characteristics

Frequency Shift (ppm) vs. Temperature (°C)

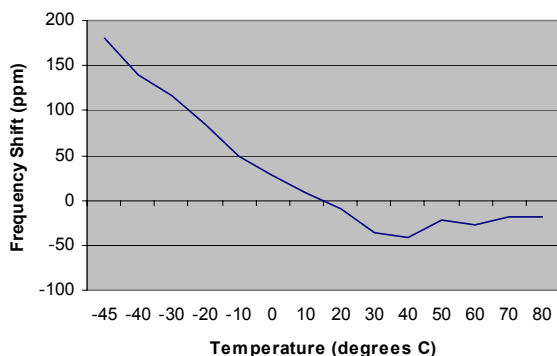

Figure 5: Typical Temperature Characteristics

Output Power Change vs. Temperature (°C)

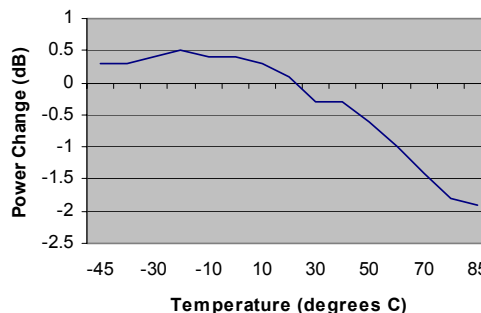
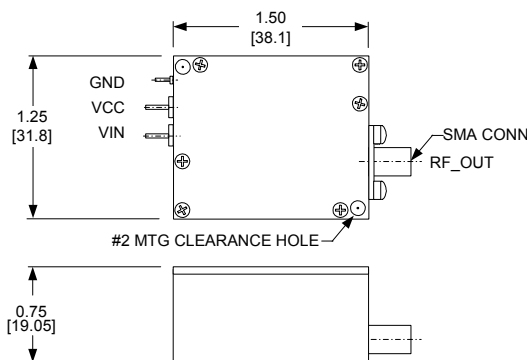

Figure 6: Output Power Change vs. Temperature (oC)

## DEVICE PACKAGE - 1.25 x 1.5 inch CONNECTOR MODULE

Mechanical Dimensions:



Dimensions are in inches;  
dimensions in [ ] are in mm  
All dimensions are  $\pm 0.02$  [0.51]

Figure 7: Device Package - 1.25 x 1.5 inch Connector Module

## ORDERING INFORMATION

For VCDRO Frequency (GHz)	Order Part Number
10.664	M635-10.6640

Table 7: Ordering Information

Consult ICS for the availability of other VCDRO frequencies.

While the information presented herein has been checked for both accuracy and reliability, Integrated Circuit Systems (ICS) assumes no responsibility for either its use or for the infringement of any patents or other rights of third parties, which would result from its use. No other circuits, patents, or licenses are implied. This product is intended for use in normal commercial applications. Any other applications such as those requiring extended temperature range, high reliability, or other extraordinary environmental requirements are not recommended without additional processing by ICS. ICS reserves the right to change any circuitry or specifications without notice. ICS does not authorize or warrant any ICS product for use in life support devices or critical medical instruments.