Features

- Operating Voltage: 5V
- Access Time: 30, 45 ns
- Very Low Power Consumption
 - Active: 600 mW (Max)
 - Standby: 1 μ W (Typ)
- Wide Temperature Range: -55-C to +125-C
- 400 Mils Width Packages: FP32 and SB32
- TTL Compatible Inputs and Outputs
- Asynchronous
- No Single Event Latch-up below a LET Threshold of 80 MeV/mg/cm²
- Tested up to a Total Dose of 30 krad(Si) according to MIL STD 883 Method 1019
- QML Q and V with SMD 5962-89598
- ESCC with Specification 9301/047

Description

The M65608E is a very low power CMOS static RAM organized as 131072 x 8 bits.

Utilizing an array of six transistors (6T) memory cells, the M65608E combines an extremely low standby supply current (Typical value = 0.2 μ A) with a fast access time at 30 ns over the full military temperature range. The high stability of the 6T cell provides excellent protection against soft errors due to noise.

The M65608E is processed according to the methods of the latest revision of the MIL PRF 38535 or ESCC 9000.



**Rad. Tolerant
128Kx8, 5-Volt
Very Low Power
CMOS SRAM**

M65608E



Block Diagram

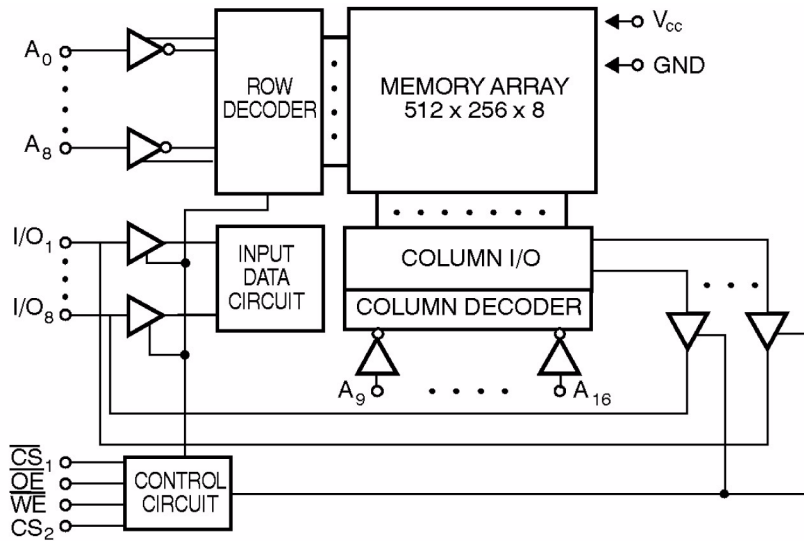

Pin Configuration

32-lead DIL side-brazed 400 MILS
 32-lead Flatpack 400 MILS

NC	1	32	VCC
A16	2	31	A15
A14	3	30	CS ₂
A12	4	29	W
A7	5	28	A13
A6	6	27	A8
A5	7	26	A9
A4	8	25	A11
A3	9	24	OE
A2	10	23	A10
A1	11	22	CS ₁
A0	12	21	I/O7
I/O0	13	20	I/O6
I/O1	14	19	I/O5
I/O2	15	18	I/O4
GND	16	17	I/O3

Pin Description

Table 1. Pin Names

Names	Description
A0 - A16	Address inputs
I/O0 - I/O7	Data Input/Output
$\overline{\text{CS1}}$	Chip select 1
CS2	Chip select 2
$\overline{\text{WE}}$	Write Enable
$\overline{\text{OE}}$	Output Enable
VCC	Power
GND	Ground

Table 2. Truth Table

$\overline{\text{CS1}}$	CS2	$\overline{\text{W}}$	$\overline{\text{OE}}$	Inputs/ Outputs	Mode
H	X	X	X	Z	Deselect/ Power-down
X	L	X	X	Z	Deselect/ power-down
L	H	H	L	Data Out	Read
L	H	L	X	Data In	Write
L	H	H	H	Z	Output Disable

Note: L = low, H = high, X = H or L, Z = high impedance.



Electrical Characteristics

Absolute Maximum Ratings

Supply voltage to GND potential: -0.5V + 7.0V	<p>*NOTE: Stresses beyond those listed under "Absolute Maximum Ratings" may cause permanent damage to the device. This is a stress rating only and functional operation of the device at these or any other conditions beyond those indicated in the operational sections of this specification is not implied. Exposure between recommended DC operating and absolute maximum rating conditions for extended periods may affect device reliability.</p>
Voltage range on any input: GND - 0.5V to VCC + 0.5	
Voltage range on any output: GND - 0.5V to VCC + 0.5	
Storage temperature: -65-C to +150-C	
Output Current from Output Pins: 20 mA	
Electrostatic Discharge Voltage: > 2000V (MIL STD 883D method 3015.3)	

Military Operating Range

Operating Voltage	Operating Temperature
5V ± 10%	-55-C to + 125-C

Recommended DC Operating Conditions

Parameter	Description	Minimum	Typical	Maximum	Unit
V _{CC}	Supply voltage	4.5	5.0	5.5	V
GND	Ground	0.0	0.0	0.0	V
V _{IL}	Input low voltage	GND - 0.5	0.0	0.8	V
V _{IH}	Input high voltage	2.2	–	VCC + 0.5	V

Capacitance

Parameter	Description	Minimum	Typical	Maximum	Unit
C _{in} ⁽¹⁾	Input low voltage	–	–	8	pF
C _{out} ⁽¹⁾	Output high voltage	–	–	8	pF

Note: 1. Guaranteed but not tested.

DC Parameters

DC Test Conditions

Table 3. DC Test Conditions

TA = -55°C to + 125°C; Vss = 0V; V_{CC} = 4.5V to 5.5V

Symbol	Description	Minimum	Typical	Maximum	Unit
IIX ⁽¹⁾	Input leakage current	-1	-	1	μA
IOZ ⁽¹⁾	Output leakage current	-1	-	1	μA
VOL ⁽²⁾	Output low voltage	-	-	0.4	V
VOH ⁽³⁾	Output high voltage	2.4	-	-	V

1. GND < V_{in} < V_{CC}; GND < V_{out} < V_{CC} Output Disabled.
2. V_{CC} min. IOL = 8 mA
3. V_{CC} min. IOH = -4 mA.

Consumption

Symbol	Description	65608E-30	65608E-45	Unit	Value
ICCSB ⁽¹⁾	Standby supply current	2	2	mA	max
ICCSB1 ⁽²⁾	Standby supply current	300	300	μA	max
ICCOP ⁽³⁾	Dynamic operating current	110	100	mA	max

1. CS1 > V_{IH} or CS2 < V_{IL} and CS1 < V_{IL}.
2. CS1 > V_{CC} - 0.3V or, CS2 < GND + 0.3V and CS1 < 0.2V.
3. F = 1/TAVAV, I_{out} = 0 mA, W = OE = V_{IH}, V_{in} = GND or V_{CC}, V_{CC} max.

AC Parameters

AC Test Conditions

Input Pulse Levels:GND to 3.0V

Input Rise/Fall Times:5 ns

Input Timing Reference Levels:1.5V

Output loading IOL/IOH (see Figure 1 and Figure 2)+30 pF

AC Test Loads Waveforms

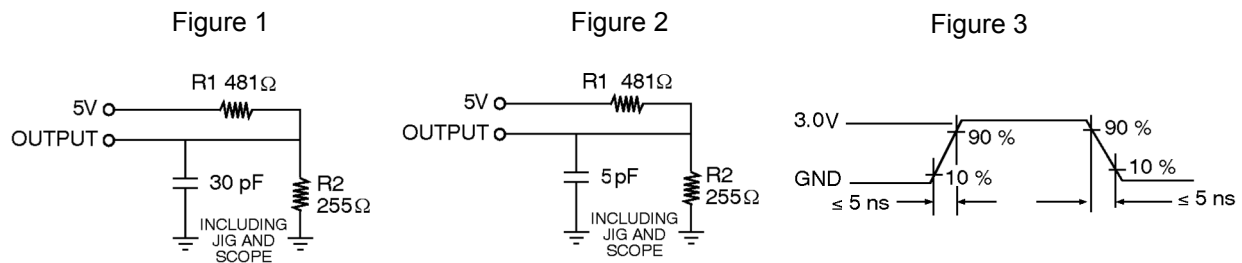

Equivalent to : THEVENIN EQUIVALENT

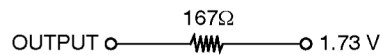

Data Retention Mode

Atmel CMOS RAM's are designed with battery backup in mind. Data retention voltage and supply current are guaranteed over temperature. The following rules ensure data retention:

1. During data retention chip select $\overline{CS1}$ must be held high within V_{CC} to $V_{CC} - 0.2V$ or, chip select $CS2$ must be held down within GND to $GND + 0.2V$.
2. Output Enable (\overline{OE}) should be held high to keep the RAM outputs high impedance, minimizing power dissipation.
3. During power up and power-down transitions $\overline{CS1}$ and \overline{OE} must be kept between $V_{CC} + 0.3V$ and 70% of V_{CC} , or with $CS2$ between GND and $GND - 0.3V$.
4. The RAM can begin operation $> t_R$ ns after V_{CC} reaches the minimum operation voltages (4.5V).

Timing

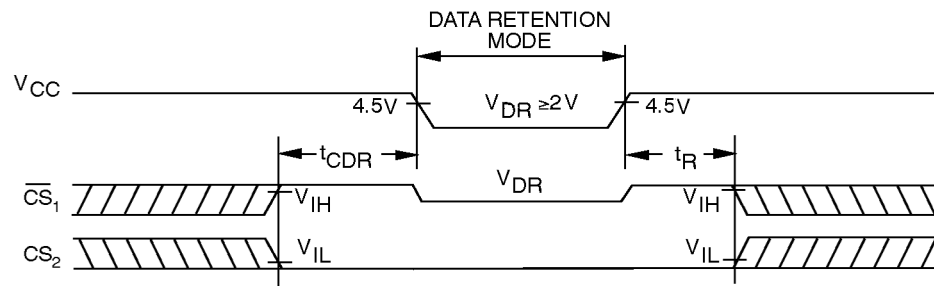

Data Retention Characteristics

Parameter	Description	Minimum	Typical TA = 25 °C	Maximum	Unit
VCCDR	V _{CC} for data retention	2.0	–	–	V
TCDR	Chip deselect to data retention time	0.0	–	–	ns
TR	Operation recovery time	TAVAV ⁽¹⁾	–	–	ns
ICCDR1	Data retention current at 2.0V	–	0.1	150	μA
ICCDR2 ⁽²⁾	Data retention current at 3.0V	–	0.2	200	μA

- Notes:
1. TAVAV = Read Cycle Time
 2. CS1 = V_{CC} or CS2 = CS1 = GND, Vin = GND/V_{CC}, this parameter is only tested at V_{CC} = 2V.
 3. Parameters guaranteed but not tested

Write Cycle

Symbol	Parameter	65608-30	65608-45	Unit	Value
TAVAW	Write cycle time	30	45	ns	min
TAVWL	Address set-up time	0	0	ns	min
TAVWH	Address valid to end of write	22	35	ns	min
TDVWH	Data set-up time	18	20	ns	min
TE1LWH	CS1 low to write end	22	35	ns	min
TE2HWH	CS2 high to write end	22	35	ns	min
TWLQZ	Write low to high Z ⁽¹⁾	8	15	ns	max
TWLWH	Write pulse width	22	35	ns	min
TWHAX	Address hold from to end of write	0	0	ns	min
TWHDX	Data hold time	0	0	ns	min
TWHQX	Write high to low Z ⁽¹⁾	0	0	ns	min

Note: 1. Parameters guaranteed, not tested, with output loading 5 pF.

Read Cycle

Symbol	Parameter	65608-30	65608-45	Unit	Value
TAVAV	Read cycle time	30	45	ns	min
TAVQV	Address access time	30	45	ns	max
TAVQX	Address valid to low Z ⁽¹⁾	5	5	ns	min
TE1LQV	Chip-select1 access time	30	45	ns	max
TE1LQX	CS1 low to low Z ⁽¹⁾	3	3	ns	min
TE1HQZ	CS1 high to high Z ⁽¹⁾	15	20	ns	max
TE2HQV	Chip-select2 access time	30	45	ns	max
TE2HQX	CS2 high to low Z ⁽¹⁾	3	3	ns	min
TE2LQZ	CS2 low to high Z ⁽¹⁾	15	20	ns	max
TGLQV	Output Enable access time	12	15	ns	max
TGLQX	OE low to low Z ⁽¹⁾	0	0	ns	min
TGHQZ	OE high to high Z ⁽¹⁾	8	15	ns	max

Note: 1. Parameters Guaranteed, not tested, with output loading 5 pF.

Write Cycle 1 \overline{WE} Controlled, \overline{OE} High During Write

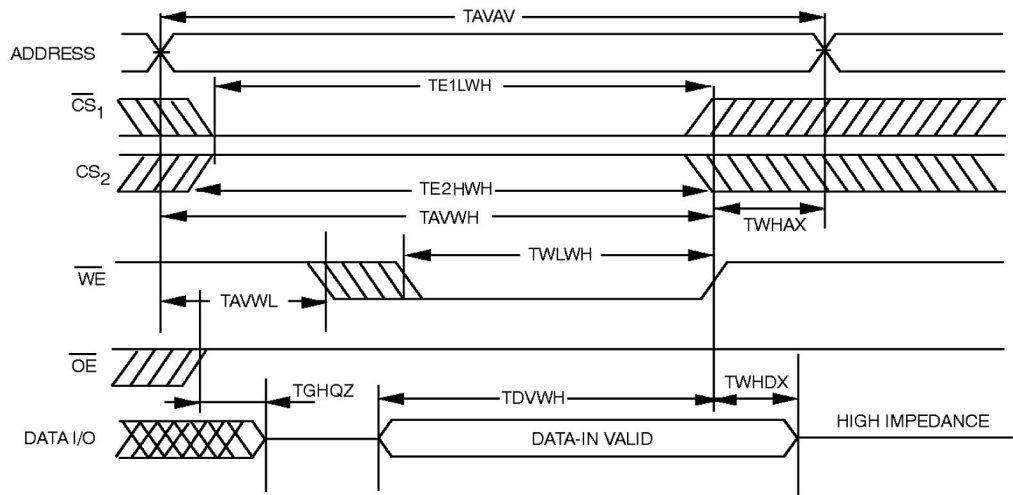

Write Cycle 2 \overline{WE} Controlled, \overline{OE} Low

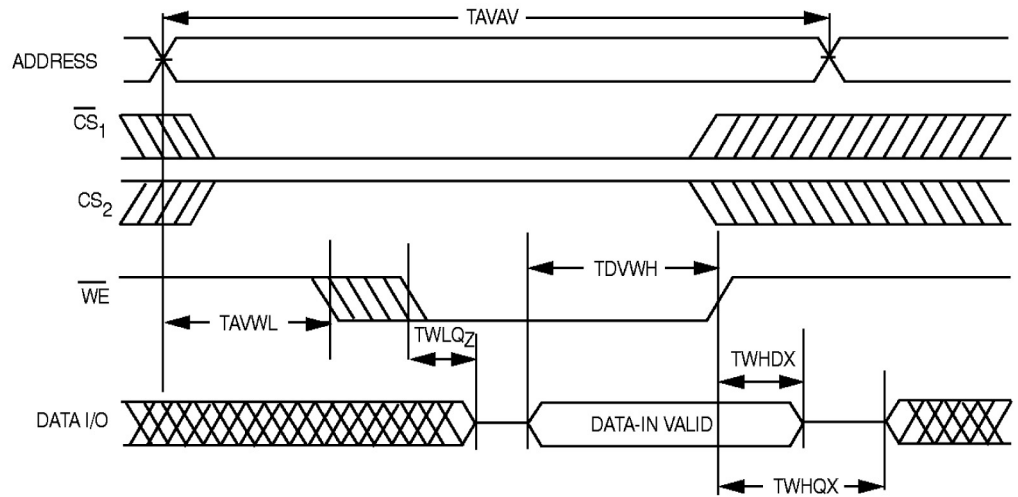

Write Cycle 3 $\overline{CS1}$ or $\overline{CS2}$, Controlled

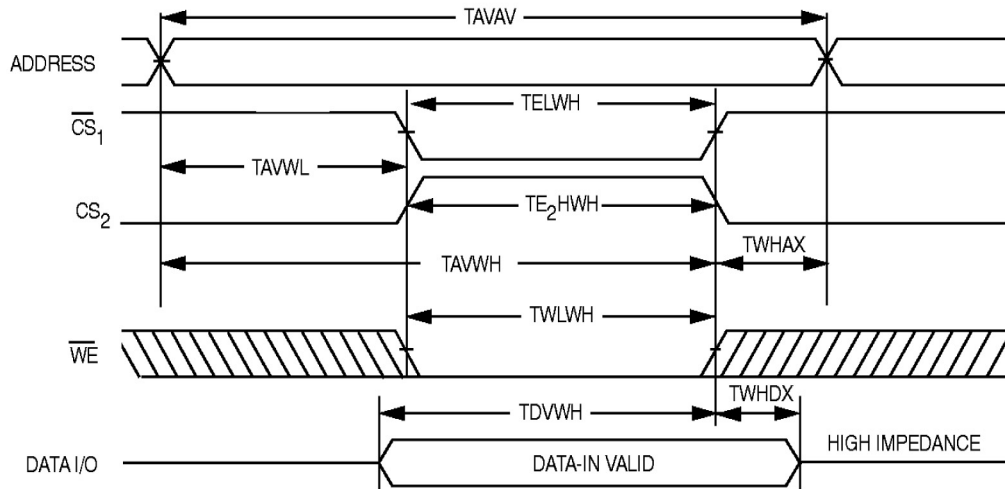

Note: The internal write time of the memory is defined by the overlap of $\overline{CS1}$ Low and $\overline{CS2}$ HIGH and \overline{WE} LOW. Both signals must be activated to initiate a write and either signal can terminate a write by going in activated. The data input setup and hold timing should be referenced to the activated edge of the signal that terminates the write. Data out is high impedance if $\overline{OE} = V_{IH}$.

Read Cycle 1

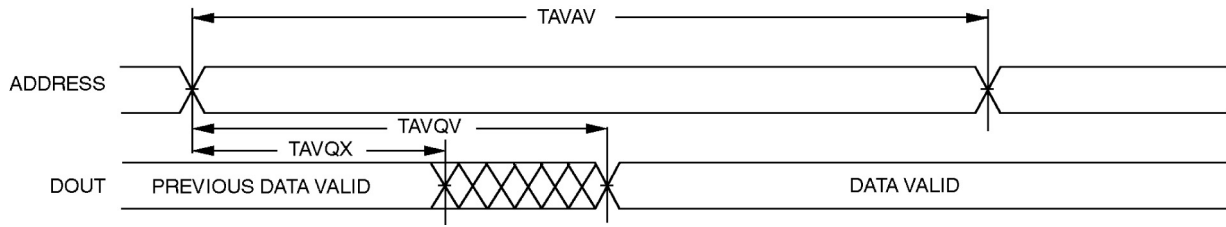

Read Cycle 2

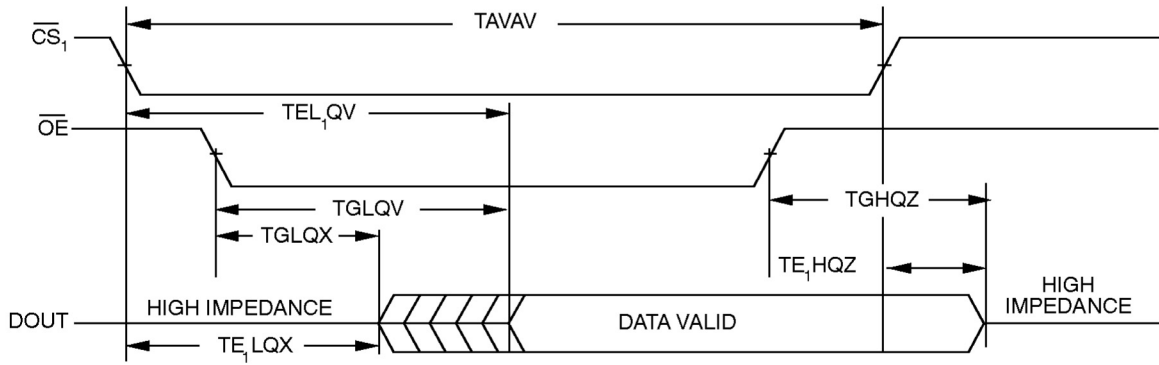

Read Cycle 3

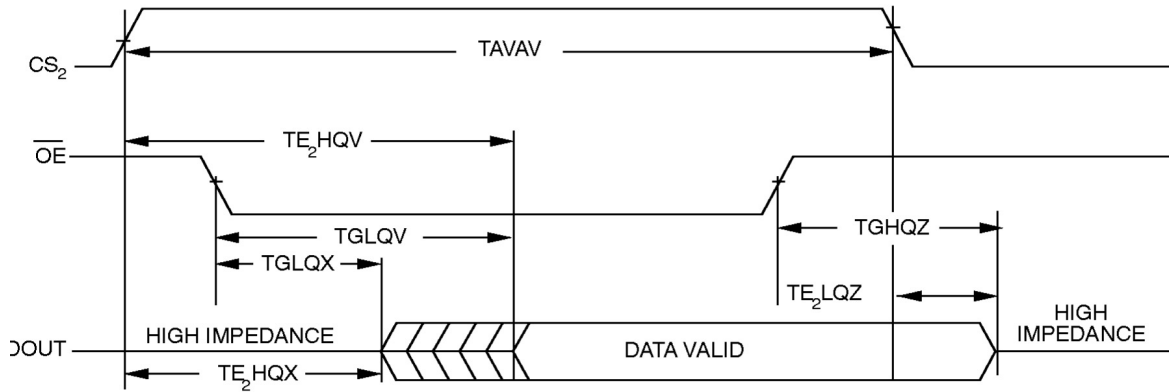



Ordering Information

Part Number	Temperature Range	Speed	Package	Flow
MMC9-65608EV-30-E ⁽¹⁾	25-C	30 ns	SB32.4	Engineering Samples
MMDJ-65608EV-30-E	25-C	30 ns	FP32.4	Engineering Samples
5962-8959847QZC	-55 to +125-C	30 ns	SB32.4	QML Q
5962-8959847QTC	-55 to +125-C	30 ns	FP32.4	QML Q
5962-8959818QZC	-55 to +125-C	45 ns	SB32.4	QML Q
5962-8959818QTC	-55 to +125-C	45 ns	FP32.4	QML Q
5962-8959847VZC	-55 to +125-C	30 ns	SB32.4	QML V
5962-8959847VTC	-55 to +125-C	30 ns	FP32.4	QML V
5962-8959818VZC	-55 to +125-C	45 ns	SB32.4	QML V
5962-8959818VTC	-55 to +125-C	45 ns	FP32.4	QML V
930104703	-55 to +125-C	30 ns	SB32.4	ESCC
930104704	-55 to +125-C	30 ns	FP32.4	ESCC
930104701	-55 to +125-C	45 ns	SB32.4	ESCC
930104702	-55 to +125-C1	45 ns	FP32.4	ESCC
MM065608EV-30-E	25-C	30 ns	Die	Engineering Samples
5962-8959847V6A	-55 to +125-C	30 ns	Die	QML V

Note: 1. Contact Atmel for availability.

Package Drawings

32-lead Flat Pack 400 Mils

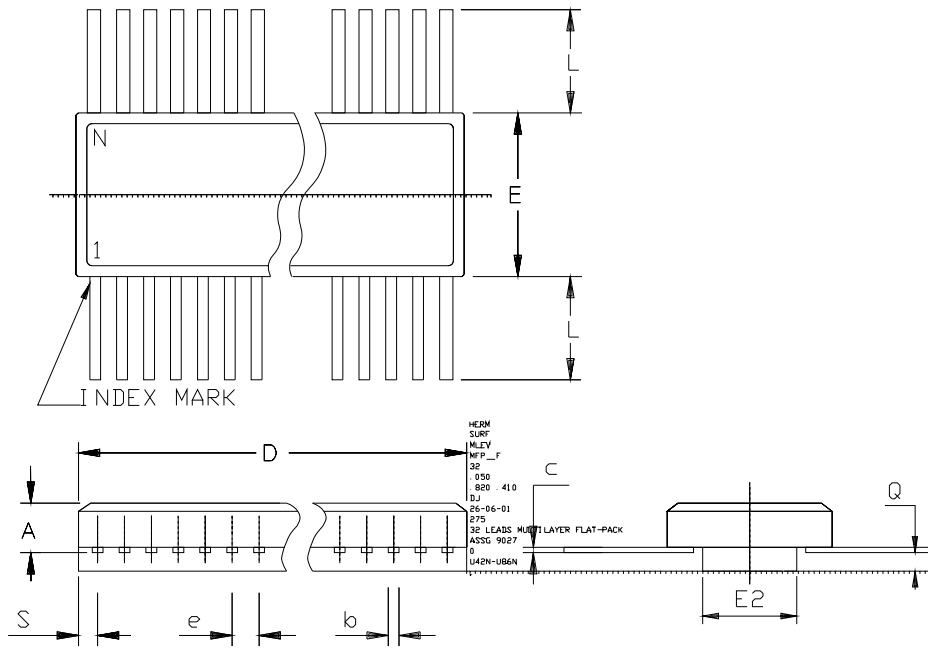

	MM		INCH	
	Min	Max	Min	Max
A	1.78	2.72	.070	.107
b	0.38	0.48	.015	.019
c	0.076	0.15	.003	.007
D	20.62	21.03	.812	.828
E	10.26	10.57	.404	.416
E2	6.96	7.26	.274	.286
e	1.27 BSC		.050 BSC	
L	7.37	7.87	.290	.310
Q	0.51	0.76	.020	.030
S	---	1.14	---	.045
N	32		32	

Package Drawings

32-lead Side Braze 400 Mils

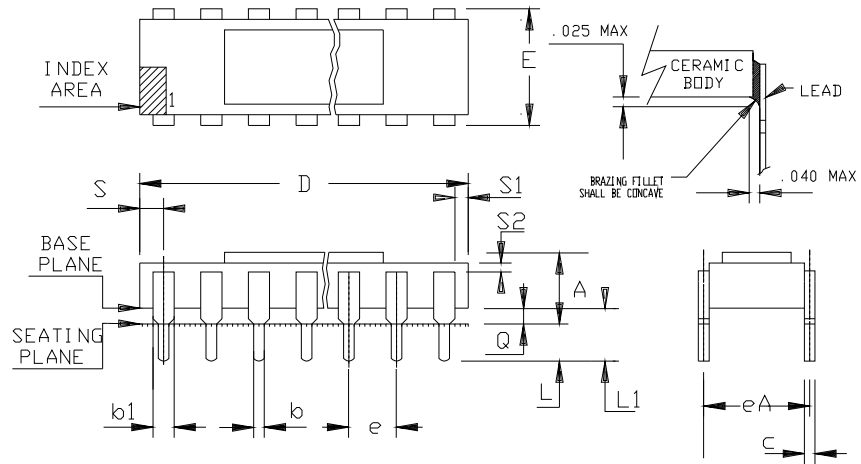

	MM		INCH	
A	2.92	4.32	.115	.170
b	0.40	0.51	.016	.020
b1	1.27 TYP		0.05 TYP	
c	0.23	0.30	.009	.012
D	40.13	41.15	1.580	1.620
E	10.16	10.67	.400	.420
eA	9.90	10.41	.390	.410
e	2.54	BSC	.100	BSC
L	3.43	4.20	.135	.165
L1	4.44	5.72	.175	.225
Q	1.02	1.52	.040	.060
S	-	1.65	-	.065
S1	0.13	-	.005	-
S2	0.13	-	.005	-

Document Revision History

Changes from Rev. L to Rev. M

1. Change in "Consumption" on page 5. ICCOP.

Changes from Rev. M to Rev. N

1. Update of footnotes under "Data Retention Characteristics" table
2. Update of Absolute Maximum Ratings section



Atmel Corporation

2325 Orchard Parkway
San Jose, CA 95131, USA
Tel: 1(408) 441-0311
Fax: 1(408) 487-2600

Regional Headquarters

Europe

Atmel Sarl
Route des Arsenalux 41
Case Postale 80
CH-1705 Fribourg
Switzerland
Tel: (41) 26-426-5555
Fax: (41) 26-426-5500

Asia

Room 1219
Chinachem Golden Plaza
77 Mody Road Tsimshatsui
East Kowloon
Hong Kong
Tel: (852) 2721-9778
Fax: (852) 2722-1369

Japan

9F, Tonetsu Shinkawa Bldg.
1-24-8 Shinkawa
Chuo-ku, Tokyo 104-0033
Japan
Tel: (81) 3-3523-3551
Fax: (81) 3-3523-7581

Atmel Operations

Memory

2325 Orchard Parkway
San Jose, CA 95131, USA
Tel: 1(408) 441-0311
Fax: 1(408) 436-4314

Microcontrollers

2325 Orchard Parkway
San Jose, CA 95131, USA
Tel: 1(408) 441-0311
Fax: 1(408) 436-4314

La Chantrerie
BP 70602
44306 Nantes Cedex 3, France
Tel: (33) 2-40-18-18-18
Fax: (33) 2-40-18-19-60

ASIC/ASSP/Smart Cards

Zone Industrielle
13106 Rousset Cedex, France
Tel: (33) 4-42-53-60-00
Fax: (33) 4-42-53-60-01

1150 East Cheyenne Mtn. Blvd.
Colorado Springs, CO 80906, USA
Tel: 1(719) 576-3300
Fax: 1(719) 540-1759

Scottish Enterprise Technology Park
Maxwell Building
East Kilbride G75 0QR, Scotland
Tel: (44) 1355-803-000
Fax: (44) 1355-242-743

RF/Automotive

Theresienstrasse 2
Postfach 3535
74025 Heilbronn, Germany
Tel: (49) 71-31-67-0
Fax: (49) 71-31-67-2340

1150 East Cheyenne Mtn. Blvd.
Colorado Springs, CO 80906, USA
Tel: 1(719) 576-3300
Fax: 1(719) 540-1759

Biometrics/Imaging/Hi-Rel MPU/ High Speed Converters/RF Datacom

Avenue de Rochepleine
BP 123
38521 Saint-Egreve Cedex, France
Tel: (33) 4-76-58-30-00
Fax: (33) 4-76-58-34-80

Literature Requests

www.atmel.com/literature

Disclaimer: The information in this document is provided in connection with Atmel products. No license, express or implied, by estoppel or otherwise, to any intellectual property right is granted by this document or in connection with the sale of Atmel products. **EXCEPT AS SET FORTH IN ATMEL'S TERMS AND CONDITIONS OF SALE LOCATED ON ATMEL'S WEB SITE, ATMEL ASSUMES NO LIABILITY WHATSOEVER AND DISCLAIMS ANY EXPRESS, IMPLIED OR STATUTORY WARRANTY RELATING TO ITS PRODUCTS INCLUDING, BUT NOT LIMITED TO, THE IMPLIED WARRANTY OF MERCHANTABILITY, FITNESS FOR A PARTICULAR PURPOSE, OR NON-INFRINGEMENT. IN NO EVENT SHALL ATMEL BE LIABLE FOR ANY DIRECT, INDIRECT, CONSEQUENTIAL, PUNITIVE, SPECIAL OR INCIDENTAL DAMAGES (INCLUDING, WITHOUT LIMITATION, DAMAGES FOR LOSS OF PROFITS, BUSINESS INTERRUPTION, OR LOSS OF INFORMATION) ARISING OUT OF THE USE OR INABILITY TO USE THIS DOCUMENT, EVEN IF ATMEL HAS BEEN ADVISED OF THE POSSIBILITY OF SUCH DAMAGES.** Atmel makes no representations or warranties with respect to the accuracy or completeness of the contents of this document and reserves the right to make changes to specifications and product descriptions at any time without notice. Atmel does not make any commitment to update the information contained herein. Unless specifically provided otherwise, Atmel products are not suitable for, and shall not be used in, automotive applications. Atmel's Atmel's products are not intended, authorized, or warranted for use as components in applications intended to support or sustain life.

©2007 Atmel Corporation. All rights reserved. Atmel®, logo and combinations thereof, and Everywhere You Are® are the trademarks or registered trademarks, of Atmel Corporation or its subsidiaries. Other terms and product names may be trademarks of others.



Printed on recycled paper.

4151N-AERO-04/09