

### DESCRIPTION

M66701P Semiconductor Integrated Circuit is built in facsimiles and photocopiers to drive CCD linear image sensor data transfer clocks at high speeds. Because this IC takes in data on the TTL (transistor-transistor logic) level, it can be driven directly by a TTL integrated circuit.

### FEATURES

- Wide operating voltage range  $V_{CC} = 8V \sim 13.2V$

### APPLICATION

Driving of CCD image sensors in facsimiles, image scanners and photocopiers

### PIN CONFIGURATION (TOP VIEW)

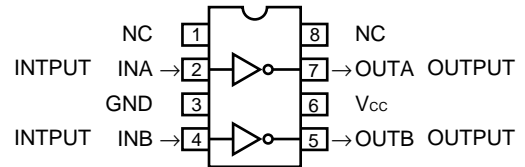

Outline 8P4

NC: No Connection

### ABSOLUTE MAXIMUM RATINGS (Ta = 0 ~ 70°C unless otherwise noted)

Symbol	Parameter	Conditions	Ratings	Unit
V <sub>CC</sub>	Supply voltage		-0.5 ~ +15	V
V <sub>I</sub>	Input voltage		-0.5 ~ +15	V
V <sub>O</sub>	Output voltage	Output: "H"	V <sub>CC</sub>	V
P <sub>d</sub>	Power dissipation	For single integrated circuit; Ta = 25°C (Note 1)	950	mW
T <sub>stg</sub>	Storage temperature		-65 ~ 150	°C

Note 1: When Ta is 25°C or higher, conduct derating as follows: 7.7mW/°C (P) /14.4mW/°C (WP).

### RECOMMENDED OPERATIONAL CONDITIONS

Symbol	Parameter	Limits			Unit
		Min.	Typ.	Max.	
V <sub>CC</sub>	Supply voltage	8.0	12.0	13.2	V
V <sub>IH</sub>	"H" input voltage	2.0			V
V <sub>IL</sub>	"L" input voltage			0.8	V
T <sub>opr</sub>	Operating temperature	0		70	°C

### ELECTRICAL CHARACTERISTICS (V<sub>CC</sub> = 8.0 ~ 13.2V, Ta = 0 ~ 70°C unless otherwise noted)

Symbol	Parameter	Test conditions	Limits			Unit
			Min.	Typ. (Note 2)	Max.	
V <sub>IH</sub>	"H" input voltage		2.0			V
V <sub>IL</sub>	"L" input voltage				0.8	V
V <sub>IC</sub>	Input clamp voltage	I <sub>IC</sub> = -18mA		-0.82	-1.5	V
V <sub>OH</sub>	"H" output voltage	V <sub>I</sub> = 0.4V, I <sub>OH</sub> = -1mA	V <sub>CC</sub> - 1	11.3		V
V <sub>OL</sub>	"L" output voltage	V <sub>I</sub> = 2.0V, I <sub>OL</sub> = +1mA		0.23	0.5	V
I <sub>IH</sub>	"H" input current	V <sub>I</sub> = 5.5V			100	μA
I <sub>IL</sub>	"L" input current	V <sub>CC</sub> = 12V, V <sub>I</sub> = 0.4V		-0.13	-0.4	mA
I <sub>CC H</sub>	"H" supply current	V <sub>CC</sub> = 12V, V <sub>I</sub> = 0.0V		5.3	8	mA
I <sub>CC L</sub>	"L" supply current	V <sub>CC</sub> = 12V, V <sub>I</sub> = 4.5V		26	35	mA

Note 2: Standard values are measured under V<sub>CC</sub> = 12V and Ta = 25°C.

**SWITCHING CHARACTERISTICS** ( $V_{CC} = 12V$ ,  $T_a = 25^\circ C$  unless otherwise noted)

Symbol	Parameter	Test conditions	Limits			Unit
			Min.	Typ.	Max.	
$t_{on}$	Turn-on time	$V_{CC} = 12V$ $R_D = 10\Omega$ (Note 3) $C_L = 1000pF$ See test circuit.		8	30	ns
$t_{off}$	Turn-off time			12	30	ns
$t_r$	Rise time			26	50	ns
$t_f$	Fall time			35	50	ns

Note 3: When M66701 is activated at high speeds, overshoot or undershoot may occur. To prevent it, connect damping resistance  $R_D$  10Ω~30Ω to output.

**TEST CIRCUIT**

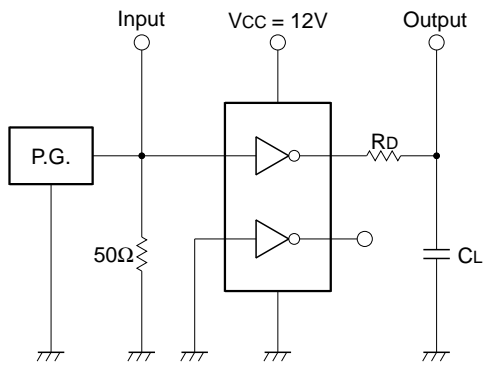

PG (pulse generator) output conditions are as follows:  
 Rise time:  $t_r \leq 6ns$   
 Fall time:  $t_f \leq 6ns$   
 Repeat frequency: PRR = 1MHz  
 Pulse width:  $t_w = 500 ns$   
 Pulse amplitude:  $V_P = 3V_{P-P}$

**TIMING CHART**

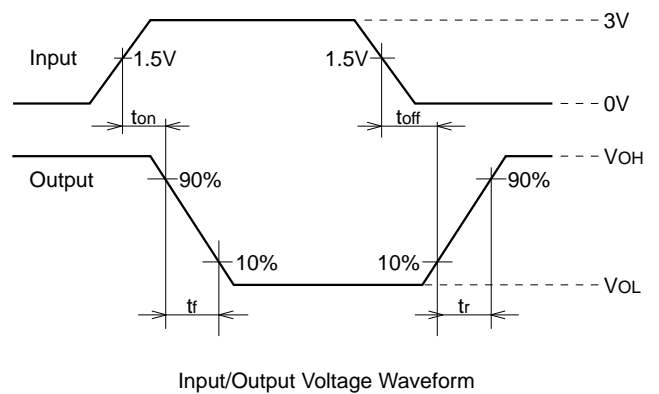

**TYPICAL CHARACTERISTICS**

SUPPLY CURRENT VS SUPPLY VOLTAGE

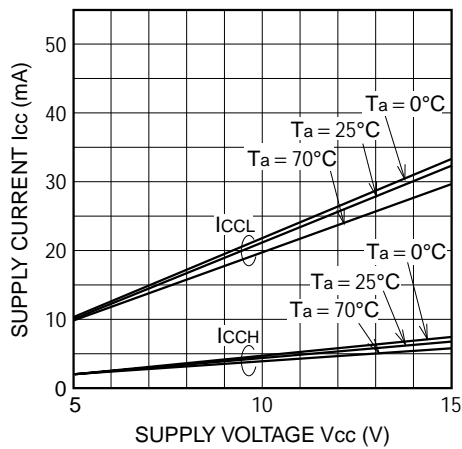

SUPPLY CURRENT VS OPERATING FREQUENCY

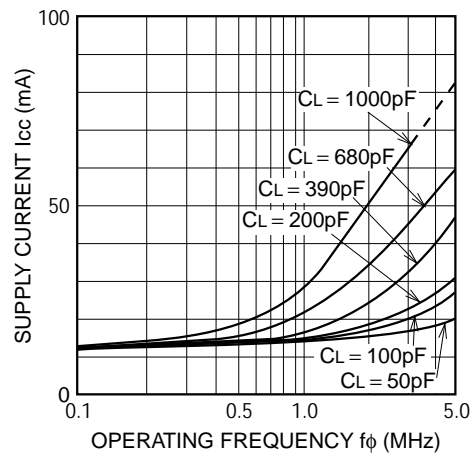

DUAL HIGH-SPEED CCD CLOCK DRIVER

"H" OUTPUT VOLTAGE VS "H" OUTPUT CURRENT

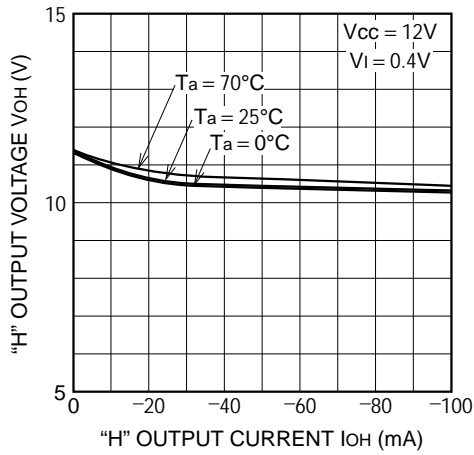

"L" OUTPUT VOLTAGE VS "L" OUTPUT CURRENT

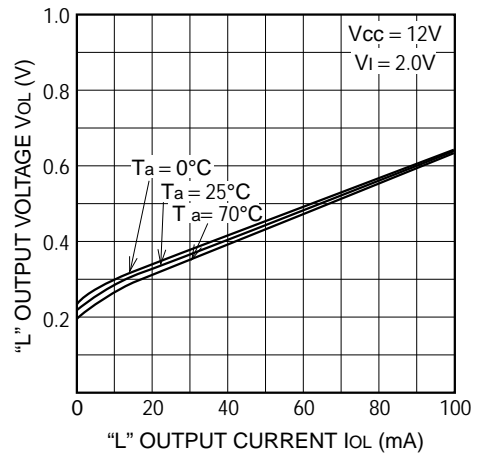

TURN-ON TIME VS AMBIENT TEMPERATURE

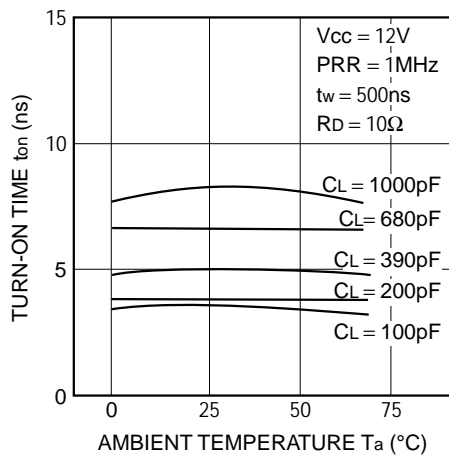

TURN-OFF TIME VS AMBIENT TEMPERATURE

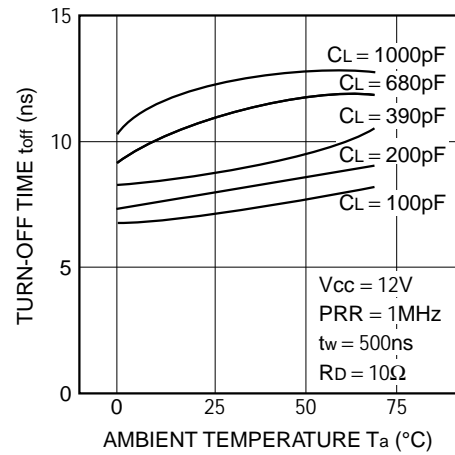

RISE TIME VS AMBIENT TEMPERATURE

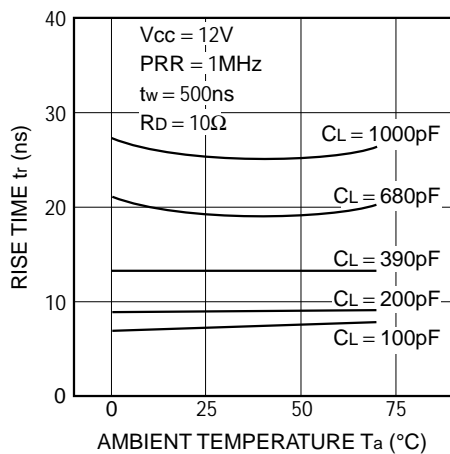

FALL TIME VS AMBIENT TEMPERATURE

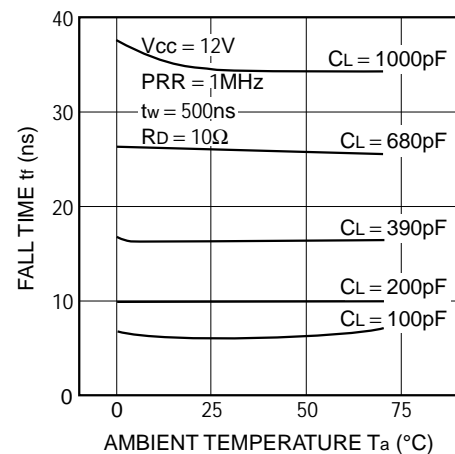

**APPLICATION CIRCUIT EXAMPLE**

