

MITSUBISHI RF POWER MODULE  
**M68741**

**SILICON MOS FET POWER AMPLIFIER, 889-915MHz, 3.8W, FM PORTABLE RADIO**

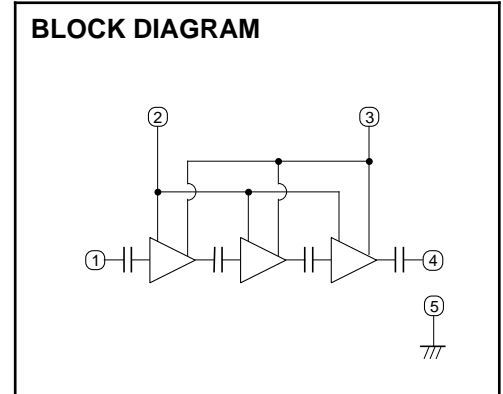
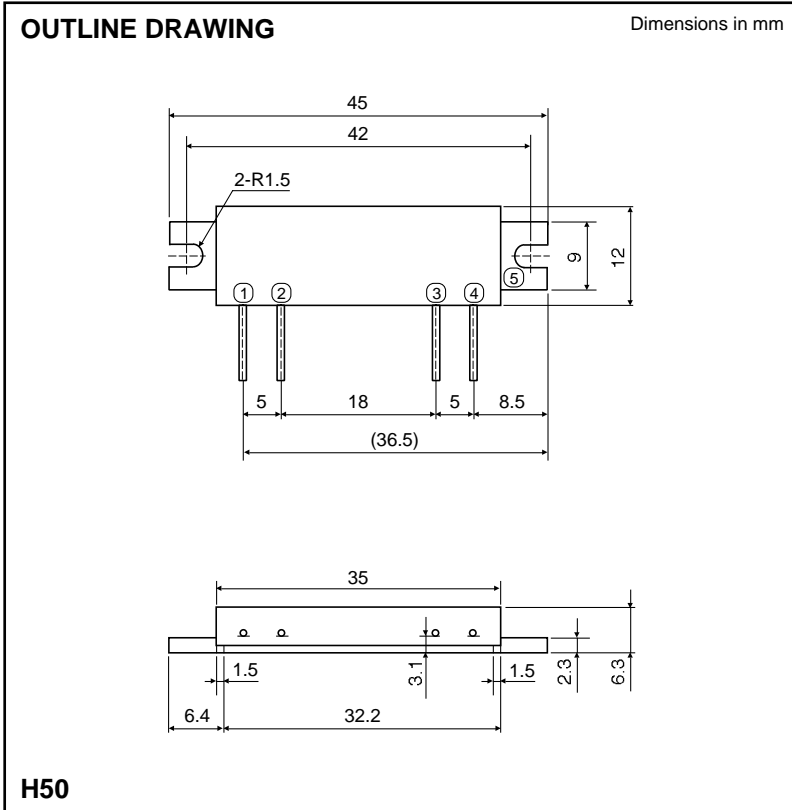

- PIN:  
 ① Pin : RF INPUT  
 ② VGG : GATE BIAS SUPPLY  
 ③ VDD : DRAIN BIAS SUPPLY  
 ④ PO : RF OUTPUT  
 ⑤ GND: FIN

**ABSOLUTE MAXIMUM RATINGS** ( $T_c=25^\circ\text{C}$  unless otherwise noted)

Symbol	Parameter	Conditions	Ratings	Unit
V <sub>DD</sub>	Supply voltage	Z <sub>G</sub> =Z <sub>L</sub> =50	9	V
V <sub>GG</sub>	Gate bias voltage		5.5	V
P <sub>in</sub>	Input power	f=889-915MHz, Z <sub>G</sub> =Z <sub>L</sub> =50	6	mW
P <sub>o</sub>	Output power	f=889-915MHz, Z <sub>G</sub> =Z <sub>L</sub> =50	6	W
T <sub>C(OP)</sub>	Operation case temperature	f=889-915MHz, Z <sub>G</sub> =Z <sub>L</sub> =50	-30 to +100	°C
T <sub>stg</sub>	Storage temperature		-40 to +100	°C

Note. Above parameters are guaranteed independently.

**ELECTRICAL CHARACTERISTICS** ( $T_c=25^\circ\text{C}$ , Z<sub>G</sub>=Z<sub>L</sub>=50 unless otherwise noted)

Symbol	Parameter	Test conditions	Limits		Unit
			Min	Max	
f	Frequency range		889	915	MHz
P <sub>o</sub>	Output power	V <sub>DD</sub> =7.2V, V <sub>GG</sub> =5V, P <sub>in</sub> =1mW, Z <sub>G</sub> =Z <sub>L</sub> =50	3.8	-	W
2f <sub>o</sub>	2nd. harmonic			-30	dBc
in	Input VSWR			4	-
τ	Total efficiency	P <sub>o</sub> =3.8W(V <sub>GG</sub> =Adjust), V <sub>DD</sub> =7.2V, P <sub>in</sub> =1mW, Z <sub>G</sub> =Z <sub>L</sub> =50	30		%
-	Stability	Z <sub>G</sub> =Z <sub>L</sub> =50, V <sub>DD</sub> =5-7.2V, Load VSWR <4:1	No parasitic oscillation		-
-	Load VSWR tolerance	V <sub>DD</sub> =9V, P <sub>in</sub> =1mW, P <sub>o</sub> =3.8W (V <sub>GG</sub> Adjust), Z <sub>L</sub> =20:1	No degradation or destroy		-

Note. Above parameters, ratings, limits and test conditions are subject to change.

SILICON MOS FET POWER AMPLIFIER, 889-915MHz, 3.8W, FM PORTABLE RADIO

TYPICAL PERFORMANCE DATA

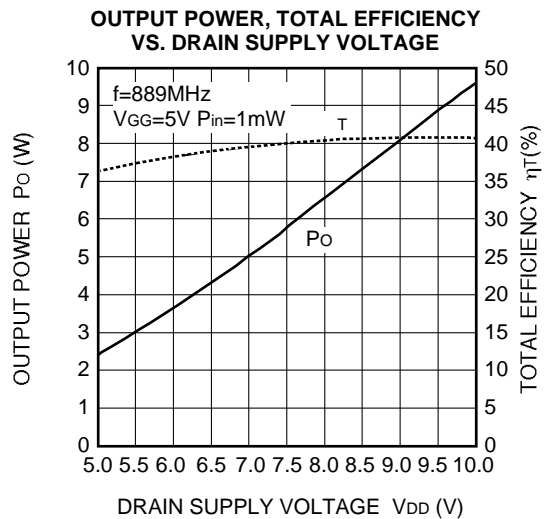
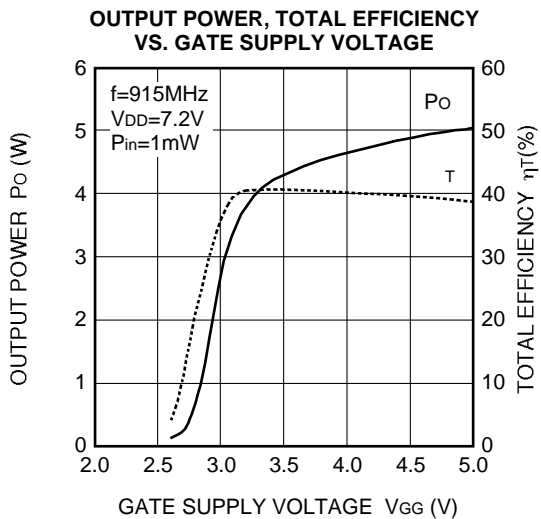
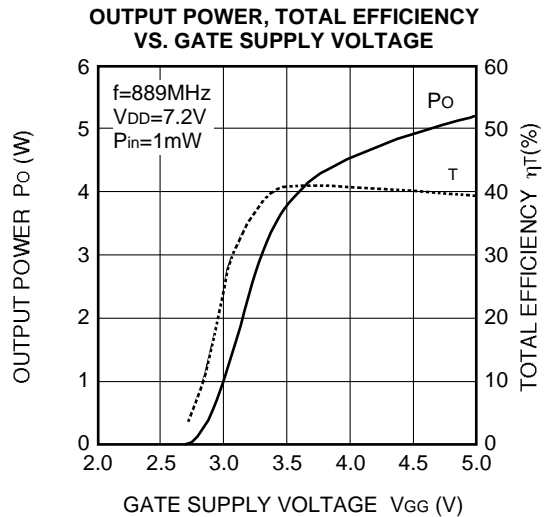
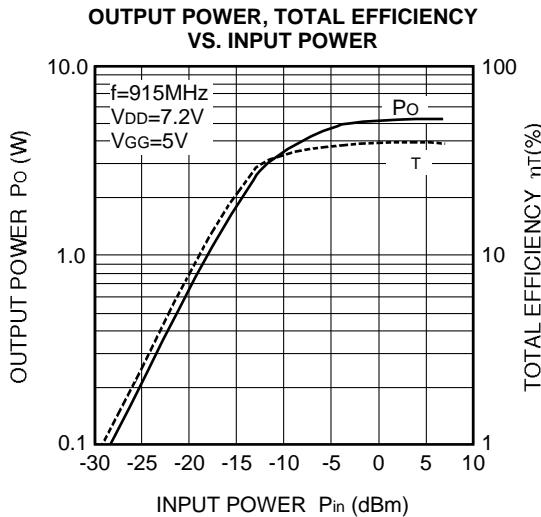
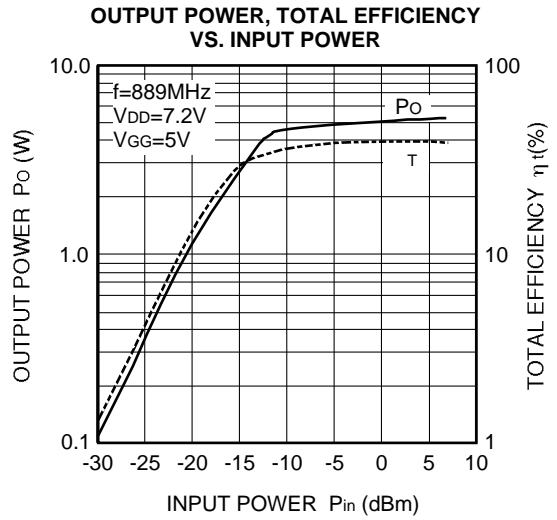
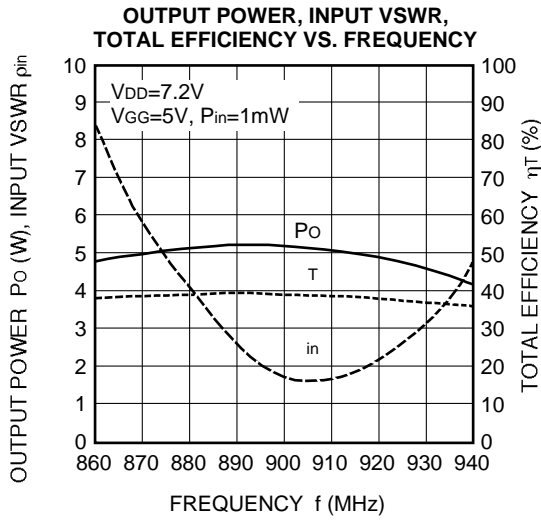

**SILICON MOS FET POWER AMPLIFIER, 889-915MHz, 3.8W, FM PORTABLE RADIO**

