

# Surface Mount Plastic PIN Diodes

## SMPP Series

### Features

- Industry Standard Surface Mount Packages
- Low Capacitance Diodes
- Low Resistance Diodes
- Low Loss Switch Diodes
- High Isolation Switch Diodes
- Low Distortion Attenuator Diodes
- Fast Switching Diodes
- Single and Dual Diode Configurations
- Tape and Reel Packaging

### Description

M/A-COM offers six unique PIN diodes in five industry standard, low cost, surface mount plastic packages. Within this series, the PIN diodes offered, feature a variety of low resistance, low capacitance and long minority carrier lifetime characteristics.

The MA4P275 has the lowest series resistance for Series Insertion Loss and Shunt Isolation switches. The MA4P789 has the lowest capacitance and offers the highest isolation in Series and Series-Shunt switches through 3 GHz. The MA4P277 and MA4P278 PIN diodes have longer intrinsic layers to produce better distortion performance in attenuators. The MA4P282 and MA4P274 are general-purpose PIN diodes useful in either switches or attenuators. These parts are available as single diodes, series pairs ( ST ), reverse series pairs ( STR ), common cathode pairs ( CK ), common anode pairs ( CA ), and unconnected pairs in the featured packages.

The SMPP series of PIN diodes is available in the SOT-23 (case style 287), the SOT-143 (case style 1068), the SOT-323 (case style 1146), the SOD-323 (case style 1141), and the SC-79 (case style 1279) packages. These packages are supplied on tape and reel for automatic pick and place assembly on surface mount circuit boards. The tape and reel suffix designation is a "T" at the end of the part number.

### Absolute Maximum Ratings @ 25°C

Parameter	Absolute Maximum
Operating Temperature	-65 °C to +150 °C
Storage Temperature	-65 °C to +150 °C
Total ( RF + DC ) Power Dissipation @+25 °C Ambient	
SOT-23, SOT-143	250 mW
SOT-323, SOD-323, SC-79	150 mW
Reverse Voltage	Voltage Rating
Forward Current	100 mA DC

### Package Outlines

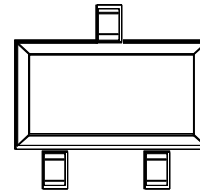
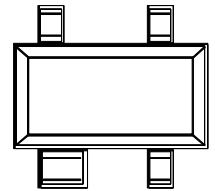
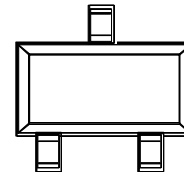
**SOT-23**

**SOT-143**

**SOT-323**

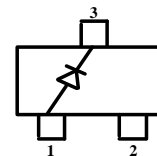
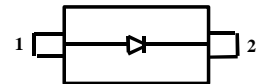
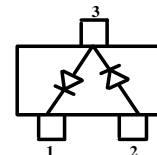
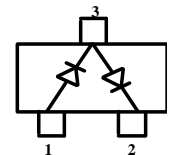
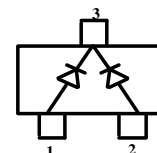
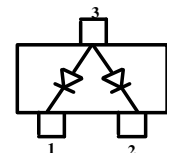
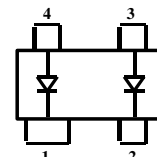
**SOD-323**

**SC-79**

### Configurations (Top View)



**Single**

**Single**

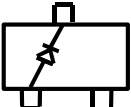
**Series Pair**

**Series Pair Reverse**

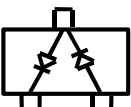
**Common Cathode**

**Common Anode**

**Unconnected Pair**

## SOT-23

## Electrical Specifications @ 25°C — SOT-23 Single Diode

Model Number	Reverse Voltage $V_R$ <sup>1</sup> (Volts)	Maximum Total Capacitance <sup>2</sup> (pF)	Maximum $R_S$ @ 10 mA <sup>3</sup> (Ohms)	Nominal Characteristics		SOT-23 Ls = 1.4 nH Cpkg = 0.12 pF
				Carrier Lifetime <sup>4</sup> (ms)	I-Region Thickness (mils)	
MA4P275-287T	75	1.00 @ 20V	0.5	0.2	0.4	
MA4P789-287T	75	0.35 @ 20V	1.5	0.2	0.4	
MA4P282-287T	100	1.20 @ 20V	0.6	1.0	0.8	
MA4P274-287T	100	0.35 @ 50V	3.0	1.0	2.0	
MA4P277-287T	200	0.35 @ 50V	6.0	2.0	4.0	
MA4P278-287T	200	0.35 @ 50V	10.0	3.0	7.0	

SOT-23 Series Pair<sup>5</sup>

Model Number	Each Diode Reverse Voltage $V_R$ <sup>1</sup> (Volts)	Each Diode Maximum Total Capacitance <sup>2</sup> (pF)	Each Diode Maximum $R_S$ @ 10 mA <sup>3</sup> (Ohms)	Nominal Characteristics		SOT-23 Ls = 1.4 nH Cpkg = 0.12 pF
				Each Diode Carrier Lifetime <sup>4</sup> (ms)	Each Diode I-Region Thickness (mils)	
MA4P275ST-287T	75	1.00 @ 20V	0.5	0.2	0.4	
MA4P789ST-287T	75	0.35 @ 20V	1.5	0.2	0.4	
MA4P274ST-287T	100	0.35 @ 50V	3.0	1.0	2.0	
MA4P282ST-287T	100	1.20 @ 20V	0.6	1.0	0.8	

## SOT-23 Common Cathode

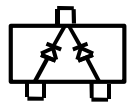
Model Number	Each Diode Reverse Voltage $V_R$ <sup>1</sup> (Volts)	Each Diode Maximum Total Capacitance <sup>2</sup> (pF)	Each Diode Maximum $R_S$ @ 10 mA <sup>3</sup> (Ohms)	Nominal Characteristics		SOT-23 Ls = 1.4 nH Cpkg = 0.12 pF
				Each Diode Carrier Lifetime <sup>4</sup> (ms)	Each Diode I-Region Thickness (mils)	
MA4P275CK-287T	75	1.00 @ 20V	0.5	0.2	0.4	
MA4P789CK-287T	75	0.35 @ 20V	1.5	0.2	0.4	
MA4P282CK-287T	100	1.20 @ 20V	0.6	1.0	0.8	
MA4P274CK-287T	100	0.35 @ 50V	3.0	1.0	2.0	

Specifications subject to change without notice.

- North America: Tel. (800) 366-2266
- Asia/Pacific: Tel. +81-44-844-8296, Fax +81-44-844-8298
- Europe: Tel. +44 (1344) 869 595, Fax +44 (1344) 300 020

Visit [www.macom.com](http://www.macom.com) for additional data sheets and product information.

## SOT-23 (Cont'd)

## SOT-23 Common Anode

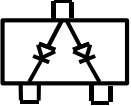
Model Number	Each Diode Reverse Voltage $V_R$ <sup>1</sup> (Volts)	Each Diode Maximum Total Capacitance <sup>2</sup> (pF)	Each Diode Maximum $R_S$ @ 10 mA <sup>3</sup> (Ohms)	Nominal Characteristics		SOT-23 Ls = 1.4 nH Cpkg = 0.12 pF
				Each Diode Carrier Lifetime <sup>4</sup> (ms)	Each Diode I-Region Thickness (mils)	
MA4P275CA-287T	75	1.00 @ 20V	0.5	0.2	0.4	
MA4P789CA-287T	75	0.35 @ 20V	1.5	0.2	0.4	
MA4P282CA-287T	100	1.20 @ 20V	0.6	1.0	0.8	
MA4P274CA-287T	100	0.35 @ 50V	3.0	1.0	2.0	
MA4P277CA-287T	200	0.35 @ 50V	6.0	2.0	4.0	
MA4P278CA-287T	200	0.35 @ 50V	10.0	3.0	7.0	

1. The reverse current will not exceed 10  $\mu$ A at the Reverse Voltage rating.
2. Maximum total capacitance is measured at 1 MHz at the indicated voltage.
3. Maximum series resistance is measured at the specified current and a frequency of 100 MHz.
4. Nominal minority lifetime is measured at  $I_F = 10$  mA,  $I_R = 6$  mA, 90% recovery.
5. Also available as reverse polarity series pairs. Designated as "MA4P275STR-287", etc.

## SOT-323

## Electrical Specifications @ 25°C — SOT-323 Single Diode

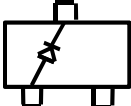
Model Number	Reverse Voltage $V_R$ <sup>1</sup> (Volts)	Maximum Total Capacitance <sup>2</sup> (pF)	Maximum $R_S$ @ 10 mA <sup>3</sup> (Ohms)	Nominal Characteristics		SOT-323 Ls = 1.3 nH Cpkg = 0.12 pF
				Carrier Lifetime <sup>4</sup> (ms)	I-Region Thickness (mils)	
MA4P275-1146T	75	1.00 @ 20V	0.5	0.2	0.4	
MA4P789-1146T	75	0.35 @ 20V	1.5	0.2	0.4	
MA4P282-1146T	100	1.20 @ 20V	0.6	1.0	0.8	
MA4P274-1146T	100	0.35 @ 50V	3.0	1.0	2.0	
MA4P277-1146T	200	0.35 @ 50V	6.0	2.0	4.0	
MA4P278-1146T	200	0.35 @ 50V	10.0	3.0	7.0	

Specifications subject to change without notice.

- North America: Tel. (800) 366-2266
- Asia/Pacific: Tel. +81-44-844-8296, Fax +81-44-844-8298
- Europe: Tel. +44 (1344) 869 595, Fax +44 (1344) 300 020

Visit [www.macom.com](http://www.macom.com) for additional data sheets and product information.

## SOT-323 (Cont'd)

SOT-323 Series Pair<sup>5</sup>

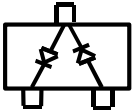
Model Number	Each Diode Reverse Voltage $V_R$ <sup>1</sup> (Volts)	Each Diode Maximum Total Capacitance <sup>2</sup> (pF)	Each Diode Maximum $R_s$ @ 10 mA <sup>3</sup> (Ohms)	Nominal Characteristics		SOT-323 Ls = 1.3 nH Cpkg = 0.12 pF
				Each Diode Carrier Lifetime <sup>4</sup> (ms)	Each Diode I-Region Thickness (mils)	
MA4P275ST-1146T	75	1.00 @ 20V	0.5	0.2	0.4	
MA4P789ST-1146T	75	0.35 @ 20V	1.5	0.2	0.4	
MA4P274ST-1146T	100	0.35 @ 50V	3.0	1.0	2.0	

## SOT-323 Common Cathode

Model Number	Each Diode Reverse Voltage $V_R$ <sup>1</sup> (Volts)	Each Diode Maximum Total Capacitance <sup>2</sup> (pF)	Each Diode Maximum $R_s$ @ 10 mA <sup>3</sup> (Ohms)	Nominal Characteristics		SOT-323 Ls = 1.3 nH Cpkg = 0.12 pF
				Each Diode Carrier Lifetime <sup>4</sup> (ms)	Each Diode I-Region Thickness (mils)	
MA4P275CK-1146T	75	1.00 @ 20V	0.5	0.2	0.4	
MA4P789CK-1146T	75	0.35 @ 20V	1.5	0.2	0.4	
MA4P274CK-1146T	100	0.35 @ 50V	3.0	1.0	0.2	

## SOT-323 Common Anode

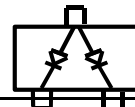
Model Number	Reverse Voltage $V_R$ <sup>1</sup> (Volts)	Maximum Total Capacitance <sup>2</sup> (pF)	Maximum $R_s$ @ 10 mA <sup>3</sup> (Ohms)	Nominal Characteristics		SOT-323 Ls = 1.3 nH Cpkg = 0.12 pF
				Carrier Lifetime <sup>4</sup> (ms)	I-Region Thickness (mils)	
MA4P275CA-1146T	75	1.00 @ 20V	0.5	0.2	0.4	
MA4P789CA-1146T	75	0.35 @ 20V	1.5	0.2	0.4	
MA4P274CA-1146T	100	0.35 @ 50V	3.0	1.0	2.0	

1. The reverse current will not exceed 10  $\mu$ A at the Reverse Voltage rating.
2. Maximum total capacitance is measured at 1 MHz at the indicated voltage.
3. Maximum series resistance is measured at the specified current and a frequency of 100 MHz.
4. Nominal minority lifetime is measured at  $I_F = 10$  mA,  $I_R = 6$  mA, 90% recovery.
5. Also available as reverse polarity series pairs. Designated as "MA4P275STR-1146", etc.

Specifications subject to change without notice.

- North America: Tel. (800) 366-2266
- Asia/Pacific: Tel. +81-44-844-8296, Fax +81-44-844-8298
- Europe: Tel. +44 (1344) 869 595, Fax +44 (1344) 300 020

Visit [www.macom.com](http://www.macom.com) for additional data sheets and product information.

## SOD-323

## Electrical Specifications @ 25°C — SOD-323 Single Diode

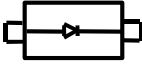
Model Number	Reverse Voltage $V_R$ <sup>1</sup> (Volts)	Maximum Total Capacitance <sup>2</sup> (pF)	Maximum $R_S$ @ 10 mA <sup>3</sup> (Ohms)	Nominal Characteristics		SOT-323 Ls = 1.2 nH Cpkg = 0.11 pF
				Carrier Lifetime <sup>4</sup> (ns)	I-Region Thickness (mils)	
MA4P275-1141T	75	1.00 @ 20V	0.5	0.2	0.4	
MA4P789-1141T	75	0.35 @ 20V	1.5	0.2	0.4	
MA4P282-1141T	100	1.20 @ 20V	0.6	1.0	0.8	
MA4P274-1141T	100	0.35 @ 50V	3.0	1.0	2.0	
MA4P277-1141T	200	0.35 @ 50V	6.0	2.0	4.0	
MA4P278-1141T	200	0.35 @ 50V	10.0	3.0	7.0	

1. The reverse current will not exceed 10  $\mu$ A at the Reverse Voltage rating.
2. Maximum total capacitance is measured at 1 MHz at the indicated voltage.
3. Maximum series resistance is measured at the specified current and a frequency of 100 MHz.
4. Nominal minority lifetime is measured at  $I_F = 10$  mA,  $I_R = 6$  mA, 90% recovery.

## SOT-143

## Electrical Specifications @ 25°C — SOT-143 Unconnected Pair

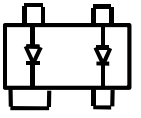
Model Number	Reverse Voltage $V_R$ <sup>1</sup> (Volts)	Maximum Total Capacitance <sup>2</sup> (pF)	Maximum $R_S$ @ 10 mA <sup>3</sup> (Ohms)	Nominal Characteristics		SOT-143 Ls = 1.2 nH Cpkg = 0.14 pF
				Carrier Lifetime <sup>4</sup> (ns)	I-Region Thickness (mils)	
MA4P275-1068T	75	1.00 @ 20V	0.5	0.2	0.4	
MA4P789-1068T	75	0.35 @ 20V	1.5	0.2	0.4	
MA4P274-1068T	100	0.35 @ 50V	3.0	1.0	2.0	

1. The reverse current will not exceed 10  $\mu$ A at the Reverse Voltage rating.
2. Maximum total capacitance is measured at 1 MHz at the indicated voltage.
3. Maximum series resistance is measured at the specified current and a frequency of 100 MHz.
4. Nominal minority lifetime is measured at  $I_F = 10$  mA,  $I_R = 6$  mA, 90% recovery.

Specifications subject to change without notice.

- North America: Tel. (800) 366-2266
- Asia/Pacific: Tel.+81-44-844-8296, Fax +81-44-844-8298
- Europe: Tel. +44 (1344) 869 595, Fax+44 (1344) 300 020

Visit [www.macom.com](http://www.macom.com) for additional data sheets and product information.

## SC-79

## Electrical Specifications @ 25°C — SC-79 Single Diode

Model Number	Reverse Voltage $V_R$ <sup>1</sup> (Volts)	Maximum Total Capacitance <sup>2</sup> (pF)	Maximum $R_S$ @ 10 mA <sup>3</sup> (Ohms)	Nominal Characteristics		SC-79 Ls = 0.6 nH Cpkg = 0.10 pF
				Carrier Lifetime <sup>4</sup> (ms)	I-Region Thickness (mils)	
MA4P275-1279T	75	1.00 @ 20V	0.5	0.2	0.4	
MA4P789-1279T	75	0.35 @ 20V	1.5	0.2	0.4	
MA4P274-1279T	100	0.35 @ 50V	3.0	1.0	2.0	
MA4P277-1279T	200	0.35 @ 50V	6.0	2.0	4.0	

1. The reverse current will not exceed 10  $\mu$ A at the Reverse Voltage rating.
2. Maximum total capacitance is measured at 1 MHz at the indicated voltage.
3. Maximum series resistance is measured at the specified current and a frequency of 100 MHz.
4. Nominal minority lifetime is measured at  $I_F = 10$  mA,  $I_R = 6$  mA, 90% recovery.

Specifications subject to change without notice.

- North America: Tel. (800) 366-2266
- Asia/Pacific: Tel.+81-44-844-8296, Fax +81-44-844-8298
- Europe: Tel. +44 (1344) 869 595, Fax+44 (1344) 300 020

Visit [www.macom.com](http://www.macom.com) for additional data sheets and product information.

Typical Forward Resistance vs DC Bias Current Curves @ 100 MHz

Resistance vs Forward Current  
(MA4P274 Series)

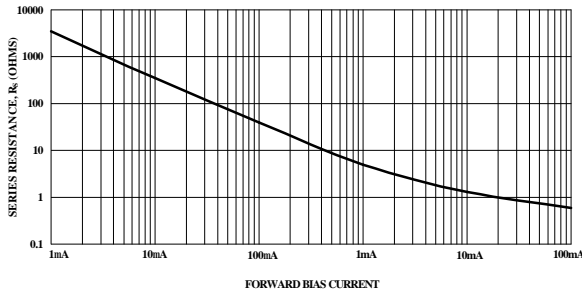

Resistance vs Forward Current  
(MA4P275 Series)

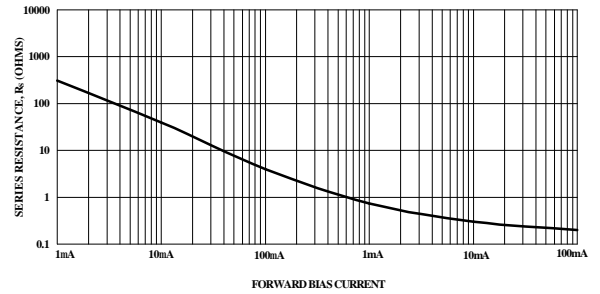

Resistance vs Forward Current  
(MA4P277 Series)

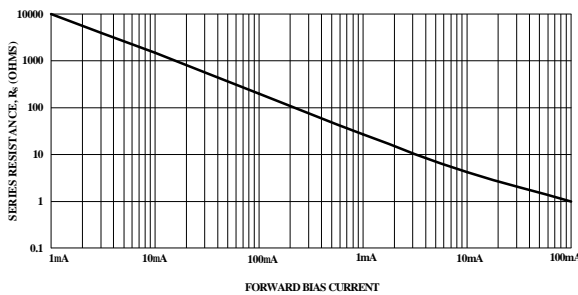

Resistance vs Forward Current  
(MA4P278 Series)

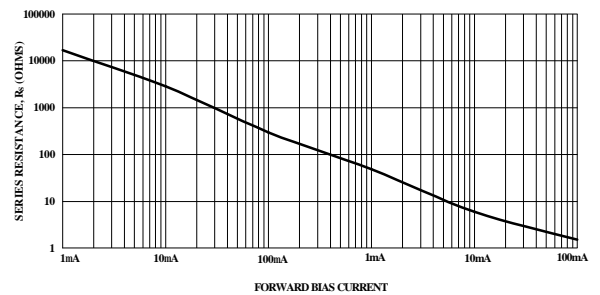

Resistance vs Forward Current  
(MA4P282 Series)

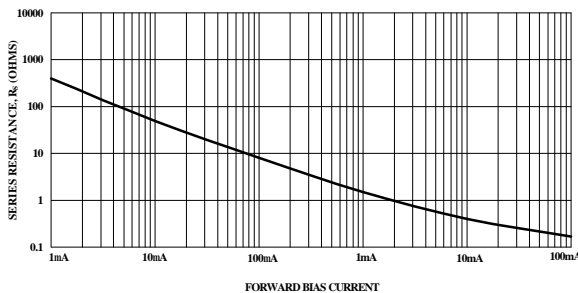

Resistance vs Forward Current  
(MA4P789 Series)

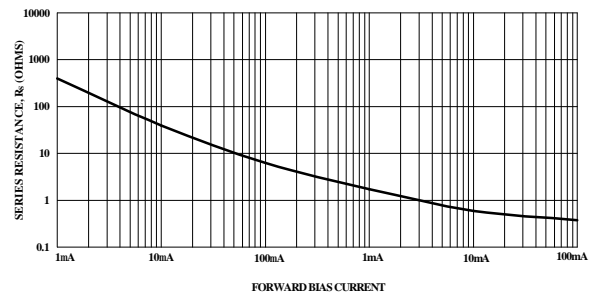

Specifications subject to change without notice.

- North America: Tel. (800) 366-2266
- Asia/Pacific: Tel.+81-44-844-8296, Fax +81-44-844-8298
- Europe: Tel. +44 (1344) 869 595, Fax+44 (1344) 300 020

Visit [www.macom.com](http://www.macom.com) for additional data sheets and product information.

### PIN Diode Cross Reference

Many of M/A-COM's glass axial lead hermetic surface mount and plastic PIN diodes use similar chips and, therefore, have the same electrical characteristics, except for package parasitics.

The following table lists the SOT-23, SOT-323 and SOD-323 PIN diodes by model number and standard axial lead PIN diode and the equivalent square surface mount (SMQ) PIN diodes.

SOT-23 Diodes	Axial Lead Glass Diodes	SMQ Diodes
MA4P274-287T	MA47123	MA4PH236
MA4P275-287T	MA4P270	MA4PH235
MA4P277-287T	MA47110	MA4PH238
MA4P278-287T	MA47100	—
MA4P282-287T	MA4PH151	—
MA4P789-287T	MA4PH401	—

SOT-323 Diodes	Axial Lead Glass Diodes	SMQ Diodes
MA4P274-1146T	MA47123	MA4PH236
MA4P275-1146T	MA4P270	MA4PH235
MA4P277-1146T	MA47110	MA4PH238
MA4P278-1146T	MA47100	—
MA4P282-1146T	MA4PH151	—
MA4P789-1146T	MA4PH401	—

SOD-323 Diodes	Axial Lead Glass Diodes	SMQ Diodes
MA4P274-1141T	MA47123	MA4PH236
MA4P275-1141T	MA4P270	MA4PH235
MA4P277-1141T	MA47110	MA4PH238
MA4P278-1141T	MA47100	—
MA4P282-1141T	MA4PH151	—
MA4P789-1141T	MA4PH401	—

### Mounting Information

The illustration indicates the recommended mounting pad configuration for the SOT-23, SOT-323, SOD-323, SOT-143, and SC-79 packages. Solder paste containing flux should be screened onto the pads to a thickness of 0.005- 0.007 inches. The plastic package device is placed in position, firmly adhering to the solder past.

Permanent attachment is performed by a reflow soldering procedure during which the tab temperature does not exceed +275°C and the body temperature does not exceed +250°C.

#### SOT-23

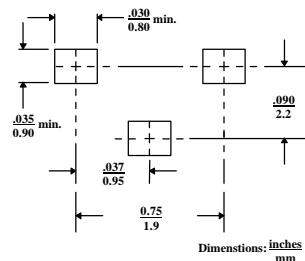

#### SOT-323

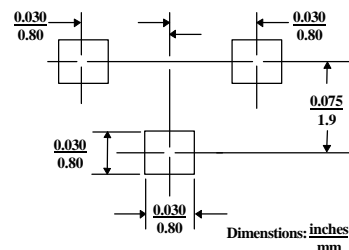

#### SOD-323

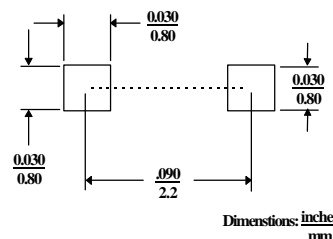

Specifications subject to change without notice.

- North America: Tel. (800) 366-2266
- Asia/Pacific: Tel.+81-44-844-8296, Fax +81-44-844-8298
- Europe: Tel. +44 (1344) 869 595, Fax+44 (1344) 300 020

Visit [www.macom.com](http://www.macom.com) for additional data sheets and product information.



SOT-143

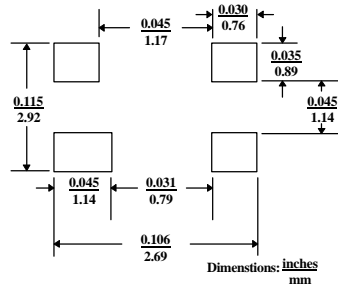

SC-79

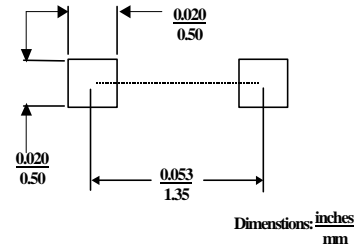

Case Styles

SOT-23  
Case Style 287

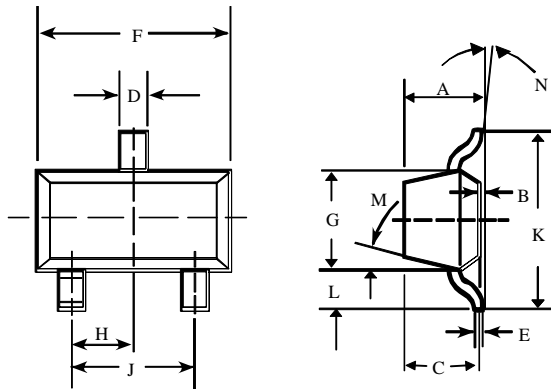

SOT-23 (Case Style 287)

DIM.	INCHES		MILLIMETERS	
	MIN.	MAX.	MIN.	MAX.
A	—	0.048	—	1.22
B	—	0.008	—	0.20
C	—	0.040	—	1.00
D	0.013	0.020	0.35	0.50
E	0.003	0.006	0.08	0.15
F	0.110	0.119	2.80	3.00
G	0.047	0.056	1.20	1.40
H	0.037 typical		0.95 typical	
J	0.075 typical		1.90 typical	
K	—	0.103	—	2.60
L	—	0.024	—	0.60
<b>DIM.</b>	<b>GRADIENT</b>			
M	10° max. <sup>1</sup>			
N	2° . . . 30°			

Note: 1. Applicable on all sides

SOT-323  
Case Style 1146

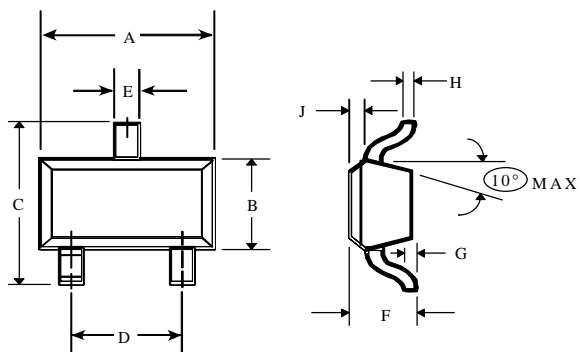

SOT-323 (Case Style 1146)

DIM.	INCHES		MILLIMETERS	
	MIN.	MAX.	MIN.	MAX.
A	0.063	0.087	1.6	2.2
B	0.045	0.053	1.15	1.35
C	0.079	0.087	2.0	2.2
D	0.047	0.055	1.2	1.4
E	0.008	0.016	0.2	0.4
F	0.031	0.039	0.8	1.0
G	—	0.004	—	0.1
H	0.003	0.006	0.08	0.15
J	0.004	0.010	0.1	0.25

Specifications subject to change without notice.

- North America: Tel. (800) 366-2266
- Asia/Pacific: Tel.+81-44-844-8296, Fax +81-44-844-8298
- Europe: Tel. +44 (1344) 869 595, Fax+44 (1344) 300 020

Visit [www.macom.com](http://www.macom.com) for additional data sheets and product information.

Case Styles (Cont'd)

SOD-323  
Case Style 1141

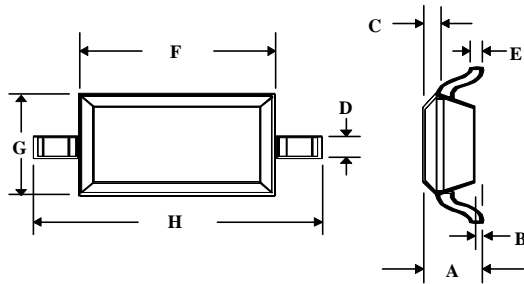

SOD-323 (Case Style 1141)

DIM.	INCHES		MILLIMETERS	
	MIN.	MAX.	MIN.	MAX.
A	—	0.043	—	1.1
B	—	0.004	—	0.1
C	—	0.008	—	0.2
D	0.010	0.016	0.25	0.4
E	0.003	0.006	0.08	0.15
F	0.063	0.075	1.6	1.9
G	0.045	0.057	1.15	1.45
H	0.091	0.106	2.3	2.7

SOT-143  
Case Style 1068

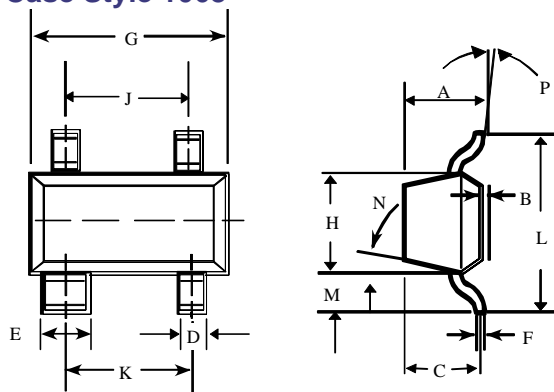

SOT-143 (Case Style 1068)

DIM.	INCHES		MILLIMETERS	
	MIN.	MAX.	MIN.	MAX.
A	—	0.044	—	1.10
B	—	0.004	—	0.10
C	—	0.040	—	1.00
D	0.013	0.020	0.35	0.50
E	0.030	0.035	0.75	0.90
F	0.003	0.006	0.08	0.15
G	0.110	0.119	2.80	3.00
H	0.047	0.056	1.20	1.40
J	0.075 typical		1.90 typical	
K	0.075 typical		1.90 typical	
L	—	0.103	—	2.6
M	—	0.024	—	0.6
<b>DIM.</b>	<b>GRADIENT</b>			
M	10° max. <sup>1</sup>			
N	2° . . . 30°			

Note: 1. Applicable on all sides

Specifications subject to change without notice.

- North America: Tel. (800) 366-2266
- Asia/Pacific: Tel.+81-44-844-8296, Fax +81-44-844-8298
- Europe: Tel. +44 (1344) 869 595, Fax+44 (1344) 300 020

Visit [www.macom.com](http://www.macom.com) for additional data sheets and product information.

Case Styles (Cont'd)

SC-79  
Case Style ODS-1279

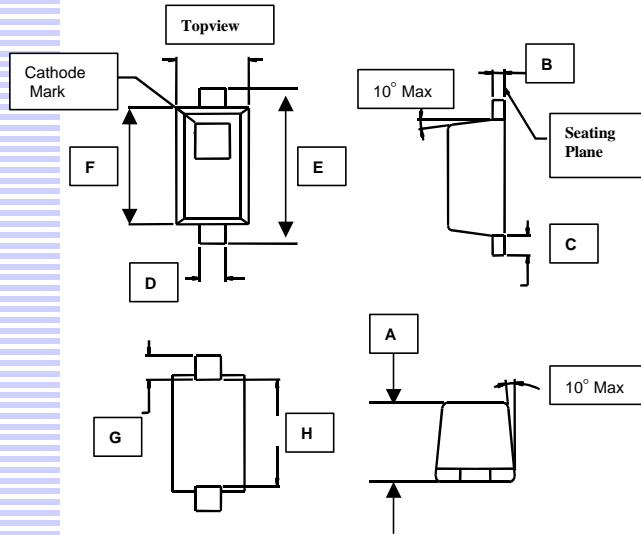

SC-79 (Case Style 1279)

DIM.	INCHES		MILLIMETERS	
	MIN.	MAX.	MIN.	MAX.
A	0.020	0.028	0.50	0.71
B	0.003	0.008	0.08	0.20
C	0.006	0.010	0.15	0.25
D	0.010	0.014	0.25	0.36
E	0.059	0.067	0.08	0.15
F	0.043	0.051	1.50	1.30
G	0.011	0.012	0.28	0.30
H	0.037	0.043	0.94	1.09

Specifications subject to change without notice.

- North America: Tel. (800) 366-2266
- Asia/Pacific: Tel.+81-44-844-8296, Fax +81-44-844-8298
- Europe: Tel. +44 (1344) 869 595, Fax+44 (1344) 300 020

Visit [www.macom.com](http://www.macom.com) for additional data sheets and product information.