

Features

- ◆ Non-Magnetic Package Suitable for MRI Applications
- ◆ Rectangular MELF SMQ Ceramic Package
- ◆ Hermetically Sealed
- ◆ Lower R_s for Lower Series Loss
- ◆ Longer τ_L for Lower Intermodulation Distortion
- ◆ Lower C_j for Higher Series Isolation
- ◆ Higher Average Incident Power Handling Capability

Description and Applications

The MA4P7461F-1072T is a surface mountable PIN diode in a Non-Magnetic (patent pending) Metal Electrode Leadless Faced (MELF) package. The device incorporates M/A-COM's proven HIPAX technology to produce a low inductance ceramic package with no ribbons or whisker wires. The package utilizes M/A-COM's new non-magnetic plating process to provide an extremely low permeability, hermetically sealed package. Incorporated in the package is a passivated PIN diode that is full face bonded on both the cathode and anode of the chip to maximize surface area for lower electrical and thermal resistance. The MA4P7461F-1072T has been comprehensively characterized both electrically and mechanically to ensure repeatable and predictable performance. This MA4P7461F-1072T non-magnetic device is similar in electrical performance to the MA4P1250-1072T and the MA4P7101F-1072T magnetic part numbers.

The diodes are well suited for use in low loss, low distortion, and high power switching circuits applicable for high magnetic field environments from HF through UHF frequencies. The lower thermal resistance of this device provides excellent higher average performance at RF power incident levels up to 100 watts CW. This device is designed to meet the most rigorous electrical and mechanical requirements of MRI testing environments.

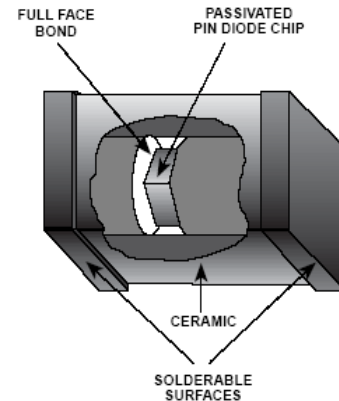

Designed for Automated Assembly

These SMQ PIN diodes are designed for high volume tape and reel assembly. The rectangular package design provides for highly efficient automatic pick and place assembly techniques. The parallel flat surfaces are suitable for key jaw or vacuum pickup techniques. All solder able surfaces are tin plated and compatible with reflow and vapor phase soldering methods.

Absolute Maximum Ratings¹ @ 25°C

Parameter	Absolute Maximum
Operating Temperature	-65°C to +125°C
Storage Temperature	-65°C to +150°C
Diode Junction Temperature	+175°C Continuous
Diode Mounting Temperature	+260°C ² for 30 secs.
RF C.W. Incident Power	+ 50 dBm C.W.
Forward Current	+150mA
Reverse Voltage @ -10uA	I -150V I

Note:

- 1) Exceeding these limits may cause permanent damage.
- 2) For more detailed mounting information, see application note M538 on the Tyco Electronics website located at

www.macom.com/Application%20Notes/pdf/M538.pdf

Packaged PIN Diodes
RoHs Compliant **Electrical Specifications @ $T_{\text{ambient}} = +25\text{ }^{\circ}\text{C}$**

Rev. V3

Parameter	Symbol	Condition	Unit Value
Forward Voltage (Maximum)	V_F	$I_F = +100\text{mA}$	$1.0V_{DC}$
Voltage Rating (Minimum)	V_R	$I_r = -10\mu\text{A}$	$I - 100 I V_{DC}$
Total Capacitance (Maximum)	C_T	$-100\text{V @ } 100\text{MHz}$	1.0 pF
Series Resistance (Maximum)	R_S	$+100\text{ mA @ } 100\text{MHz}$	$0.5\ \Omega$
Parallel Resistance (Minimum)	R_P	$-10\text{ V @ } 100\text{MHz}$	$20\text{ K } \Omega$
Carrier Lifetime (Nominal)	τ_L	$+6\text{mA} / -10\text{mA @}$ $(50\% - 90\% \text{ Voltage})$	$6.0\mu\text{s}$
I-Region Length (Nominal)	μm	-	$100\mu\text{m}$
C.W. Thermal Resistance (Maximum)	θ	$I_H = 1\text{A}, I_L = 10\text{mA},$ $T = 1\text{mS}$	15°C/W
Power Dissipation in Free Air (Maximum)	W	$I_F = +100\text{mA}$	3W
Power Dissipation with Diode Case at T_{ambient} (Maximum)	P_D	$I_F = +100\text{mA}$	8W

Typical Electrical Performance

MA4P7461F-1072T R_S vs I

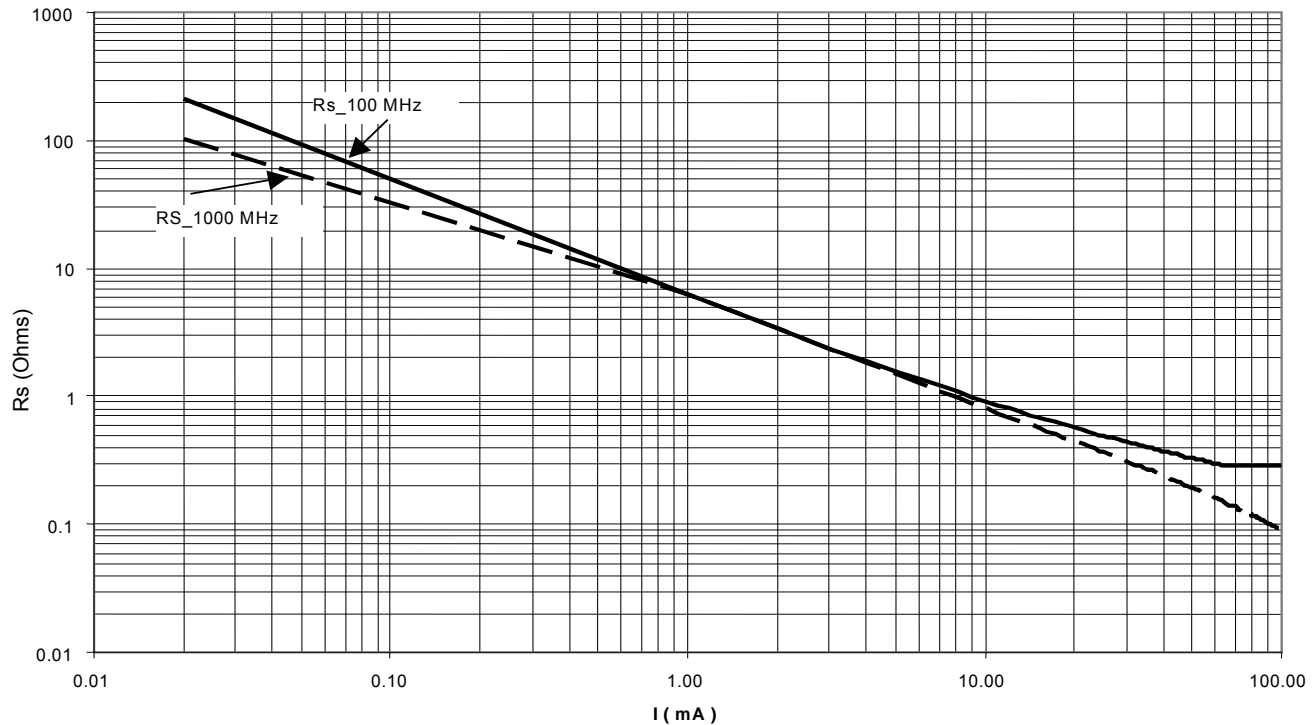

MA4P7461F-1072T Rp vs Voltage

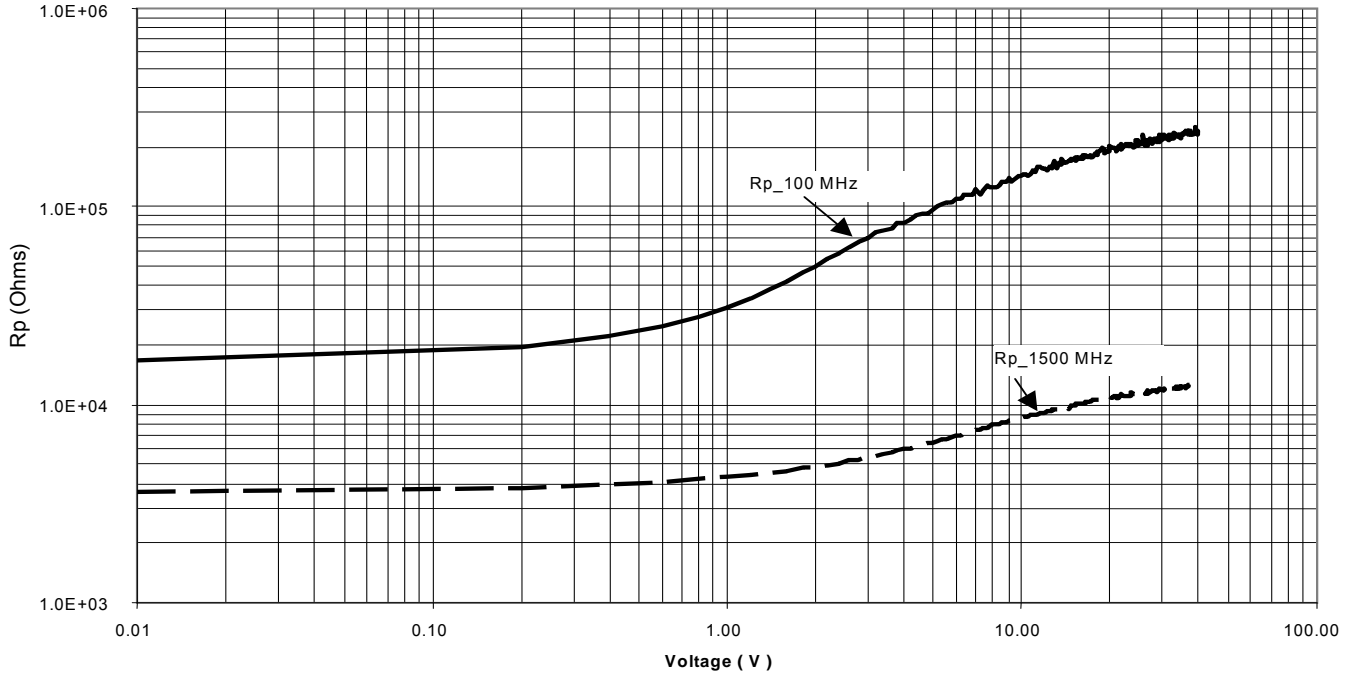

MA4P7461F-1072T Ct vs Voltage

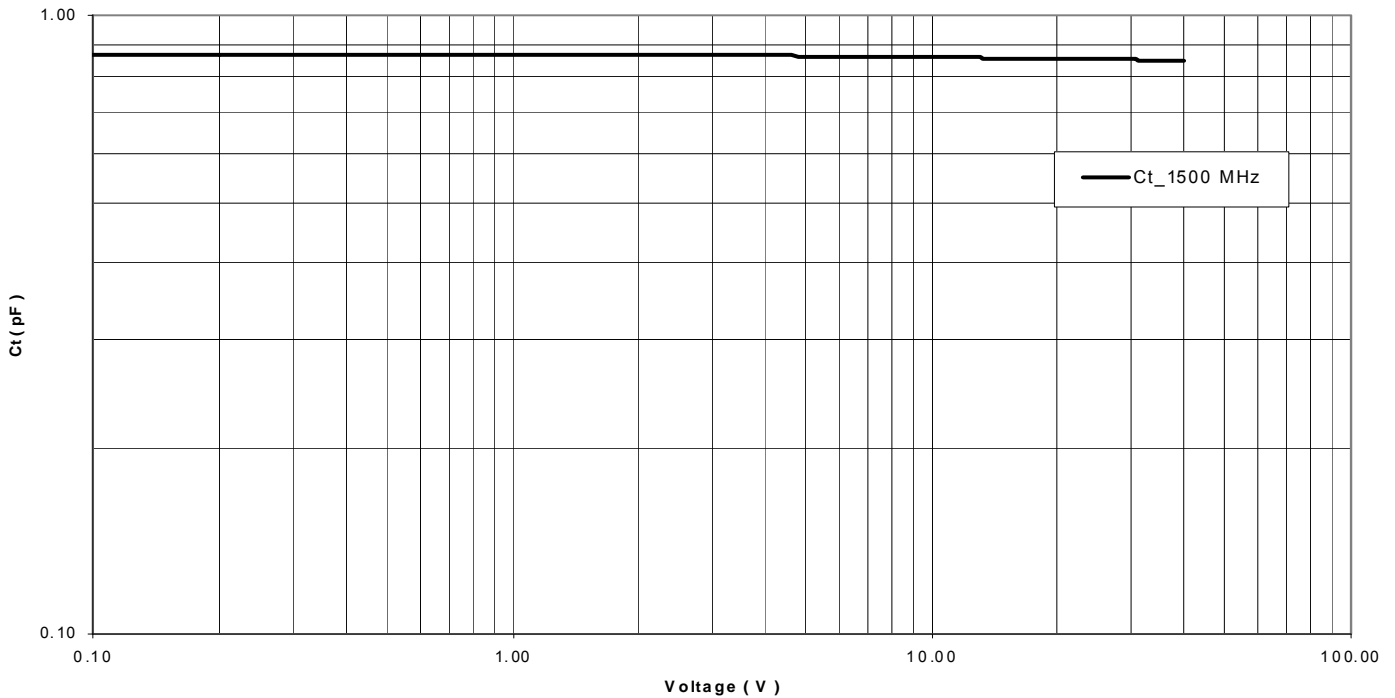

Comparison of Magnetic Moment vs H Field for MA4P7461F-1072T & MA4P1250-1072T Devices

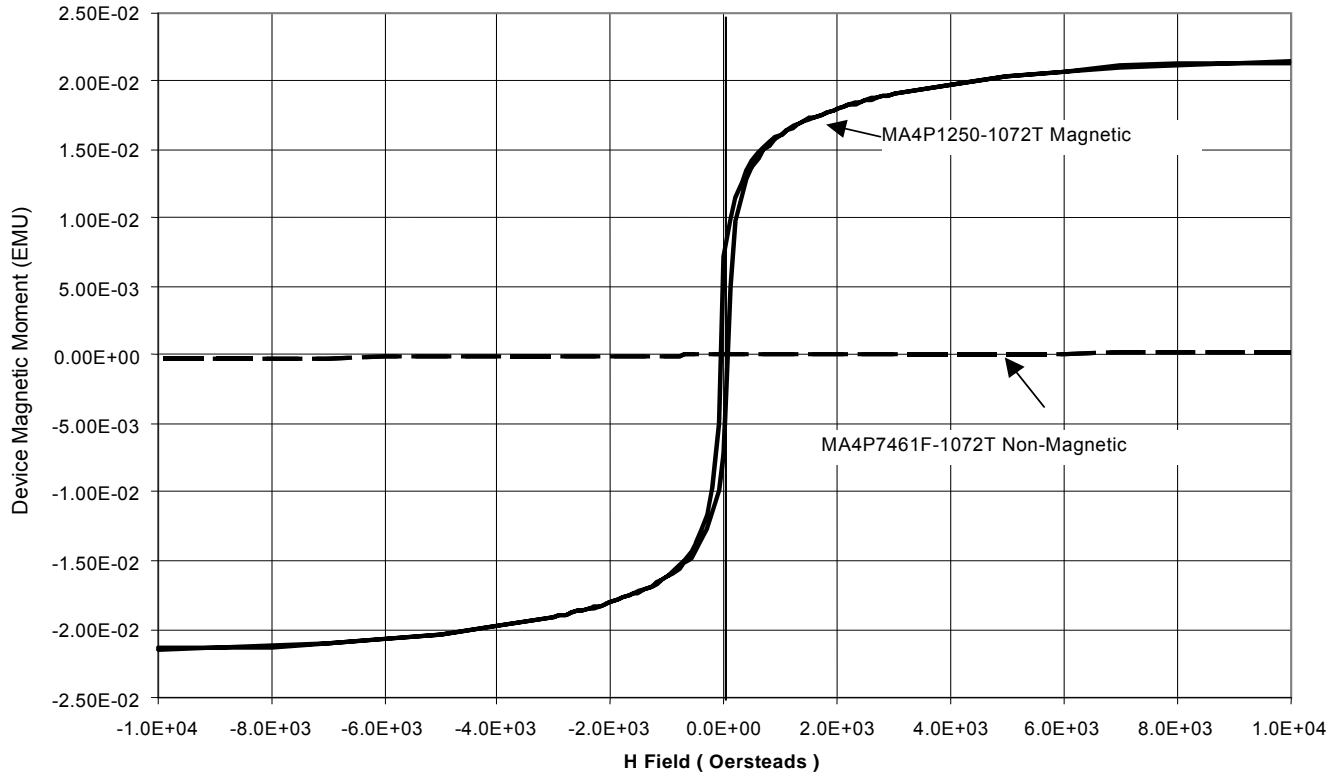

Conventional MA4P1250F-1072T Magnetic Device vs. Non-Magnetic Properties of the MA4P7461F-1072T Device

Magnetic Property	MA4P7461F-1072T	MA4P1250-1072T
Saturation Moment (EMU) @ H = H _{MAX} Oersteds	2.3 x E-4	2.1 x E-2
Remanance Moment (EMU)@ H = 0 Oersteds	4.2 x E-8	7.1 x E-3
Coercivity (Oersteds)@ EMU = 0 Moment	1	59.2

Packaged PIN Diodes

Environmental Capability

HIPAX devices are applicable for use in industrial and military applications and can be screened to meet the environmental requirements of MIL-STD-750, MIL-STD-202 as well as other military standards. The table below lists some of the MIL-STD 750 tests the device is designed to meet.

MIL-STD-750		
Test	Method	Description
High Temperature Storage	1031	+150°C, for 340 Hours
Temperature Shock	1051	-65°C to +125°C, 20 Cycles
HTRB	1038	80% of rated V_B , +150°C, for 96 Hours
Moisture Resistance	1021	No Initial Conditioning, 85% RH, +85°C
Gross Leak	1071 Cond. E	Dye Penetrant Visual
Vibration Fatigue	2046	20,000 G's, 60 Hz, x, y, z axis
Solderability	2026	Test Temperature = +245°C

Mechanical Outline

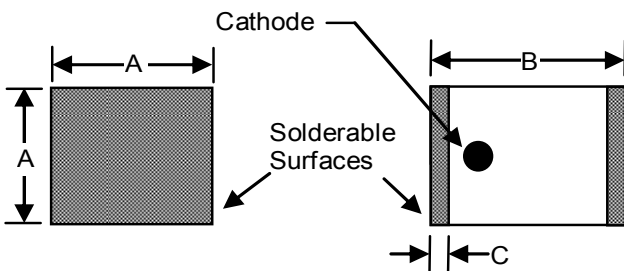

Bonding Pad Layout for 1072 Diodes

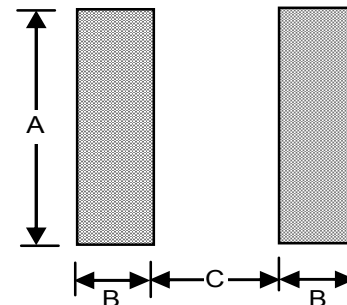

Case Style 1072	Dimensions in Inches (mm)		
	A	B	C
	Min / Max	Min / Max	Min / Max
	0.080/.095 (.203/.241)	0.115/.135 (2.92/3.43)	0.008/.030 (.203/.762)

Dimension	Case Style 1072	
	inches	mm
A	0.093	2.36
B	0.05	1.27
C	0.06	1.52

Ordering Information

Part Number	Package
MA4P7461F-1072T	Tape and Reel