

Ultra Linear 2W Power Amplifier 800 to 1000 MHz

Rev. V3

Features

- HIGH Gain: 19 dB (TYP.)
- HIGH P1dB: +34.0 dBm (TYP.)
- HIGH OIP3: +49.5 dBm (TYP.)
- 50% PAE @ P1dB
- Optimized Performance for RFID Bands
- >1 watt Dense Reader Mode Spectral Mask Compliance
- On-Chip Active Bias Network
- Lead Free 4 mm PQFN Surface Mount Package
- 260°C Reflow Capability

Applications

- RFID Readers
- Cellular Infrastructure
- AMPS, ISM Applications
- Multi-Carrier Applications

Description

M/A-COM's MAAP-007649-000100 2 watt power amplifier utilizes GaAs HBT technology with a +20 Volt BV_{ceo} process for improved linearity performance, power efficiency, and high reliability, in a low cost 4 mm PQFN surface mount plastic package.

The MAAP-007649-000100 incorporates an on-chip active bias network for ease of implementation, and maintains high linearity over temperature. The device operates from a single +7.5 volt supply and has a +4.5 volt reference pin for power down control capability.

The MAAP-007649-000100 has been optimized as a power amplifier for RFID Reader applications, but can also be used for infrastructure and industrial applications, since it provides consistent performance over the entire 800 to 1000 MHz band.

Ordering Information¹

Part Number	Package
MAAP-007649-000100	4 mm 16 lead PQFN
MAAP-007649-0001A1	Sample Application Kit (860 to 930 MHz)
MAAP-007649-0001A2	Sample Application Kit (960 MHz)

1. Reference Application Note M513 for reel size information.

Product Image

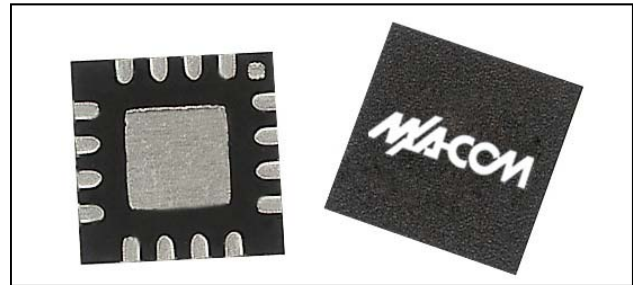

Functional Block Diagram

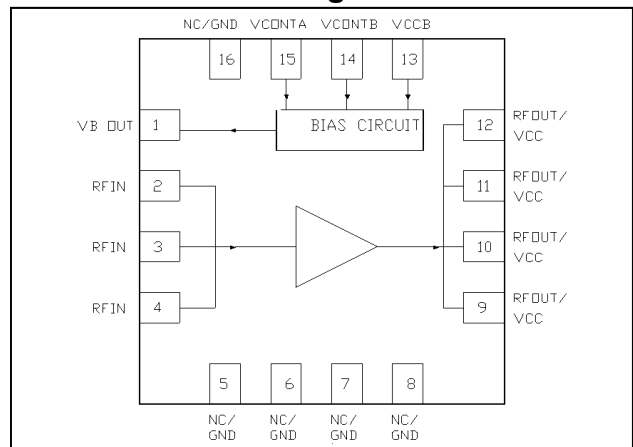

Pin Configuration

Pin No.	Function	Description
1	VB OUT	Output for base bias to PA device from on-chip bias circuit. See schematic.
2	RF INPUT	RF Input Signal
3	RF INPUT	RF Input Signal
4	RF INPUT	RF Input Signal
5	No Connection or GND	No Connection. GND preferred
6	No Connection or GND	No Connection. GND preferred
7	No Connection or GND	No Connection. GND preferred
8	No Connection or GND	No Connection. GND preferred
9	RF Output / VCC	RF Output & VCC Supply Input
10	RF Output / VCC	RF Output & VCC Supply Input
11	RF Output / VCC	RF Output & VCC Supply Input
12	RF Output / VCC	RF Output & VCC Supply Input
13	VCCB	VCC supply to Bias Circuit
14	VCONT B	Control Input. Normally not connected. May be used only when the external bias setting resistor option is desired.
15	VCONT A	Control Input to PA when on-chip bias setting resistor is used. Recommended normal operation with VCONT = +4.4 V.
16	N/C	No Connection. GND preferred
Pkg. Base	GND	RF/DC GND and thermal path to PCB vias. Sufficient vias must be provided for thermal considerations. See PCB layout.

Ultra Linear 2W Power Amplifier 800 to 1000 MHz

Rev. V3

Electrical Specifications¹ (T_c = +25°C, V_{CONT} = 4.4 V, V_{CC} = 7.5 V, Z₀ = 50 Ω, CW)

Parameter	Test Conditions	Units	Min	Typ	Max
Frequency Range ²		MHz	800		1000
Gain	860 to 930 MHz Band	dB		19.5	
	960 MHz Band	dB		19	
Gain Variation	Over Temp = -40°C to +85°C	dB		1.3	
Input Return Loss	860 to 930 MHz Band	dB	-10	-15	
	960 MHz Band	dB	-10	-15	
Output Return Loss	860 to 960 Band	dB	-8	-11	
Output P1dB	860 to 960 Band	dBm	33	34	
PAE	860 to 960 Band @ P1dB	%	46	50	
Output IP3 (2 Tone, ΔF = 1MHz)	P _{out} = +20 dBm / tone, 860 to 960 MHz	dBm	47	49	
	P _{out} = +27 dBm / tone, 860 to 960 MHz	dBm	43	44.5	
Spectral Linearity	P _{out} for DRM ³ Mask compliance	dBm		30.7	
Harmonics	@ P _{out} = 28 to 30 dBm	dBc		-48	
Bias Supply	VCC	V		7.5	8.5
Control Voltage	V _{CONT} Power Amp ON	V	4.1	4.4	4.7
	V _{CONT} Power Amp OFF	V			2
Bias Current	Quiescent Current I _{ccq}	mA		540	590
	Control current I _{cont}	mA		8	10
Current Variation	-10°C to +70°C, @ P _{out} = +31 dBm	%		3	6
Ruggedness	Load VSWR 8:1 max., 0° to 360° Phase, P _{out} < 31 dBm, Z _L = 50 Ω		No Permanent Damage		
Thermal Resistance θ _{jc} ⁵		°C/W	16.6°C/W		
Junction Temperature Rise Above Baseplate T _{jc} ⁵		°C	68°C		

- All data is based on the Evaluation Circuit Board (page 6), which is tuned specifically for 860 to 960 MHz (RFID Band), and is attached to a solid metal base for heat sinking.
NOTE: Improper heat sinking can degrade performance.
- The device is capable of operating from 800 to 1000 MHz, with an optimized I/O match over narrow bands.
- DRM Mask: EPC Global Class 1 Generation Dense Reader Mode Spectral Mask.
- Caution: Operation beyond Absolute Maximum Ratings can degrade performance or cause permanent damage.
- Heat dissipates through several layers between the transistor junctions and metal baseplate. The PQFN packaged assembly (HBT MMIC die / conductive epoxy / metal slug interface) is mounted to the application circuit board using SN63 solder. The metal vias in the circuit board dissipate heat to the baseplate.

Operating the MAAP-007649-000100

The MAAM-007649-000100 can be damaged by electrostatic discharge (ESD). Use proper ESD control techniques when handling this device. To operate the MAAP-007649-000100, follow these steps:

- 1.) Connect the 50 ohm load
- 2.) Apply VCC (+7.5 Vdc)
- 3.) Apply VCONT (+4.4 Vdc)
- 4.) Set the Input Power Level (P_{in})
- 5.) Turn off in reverse order

Absolute Maximum Ratings⁴

Parameter	Absolute Maximum
RF Input Power	+18 dBm
Supply Voltage VCC	8.5 V
Control Voltage VCONT	5 V
Supply Current with RF Drive	800 mA
Supply Current without RF Drive	600 mA
Load VSWR	8:1
Duty Cycle with Heat Sink Block	100%
Duty Cycle without Heat Sink Block	50%
Operating Temperature	-40°C to +85°C
Storage Temperature	-65°C to +150°C
Device Junction Temperature T _j , max	150°C

2

ADVANCED: Data Sheets contain information regarding a product M/A-COM Technology Solutions is considering for development. Performance is based on target specifications, simulated results, and/or prototype measurements. Commitment to develop is not guaranteed.
PRELIMINARY: Data Sheets contain information regarding a product M/A-COM Technology Solutions has under development. Performance is based on engineering tests. Specifications are typical. Mechanical outline has been fixed. Engineering samples and/or test data may be available. Commitment to produce in volume is not guaranteed.

• **North America** Tel: 800.366.2266 • **Europe** Tel: +353.21.244.6400
• **India** Tel: +91.80.4155721 • **China** Tel: +86.21.2407.1588
Visit www.macomtech.com for additional data sheets and product information.

M/A-COM Technology Solutions Inc. and its affiliates reserve the right to make changes to the product(s) or information contained herein without notice.

Typical Performance Curves at +25°C (Vcont = 4.4V @ 7 mA, VCC = 7.5V @ Icq = 540 mA)

Gain vs Frequency (860 & 915 Band)

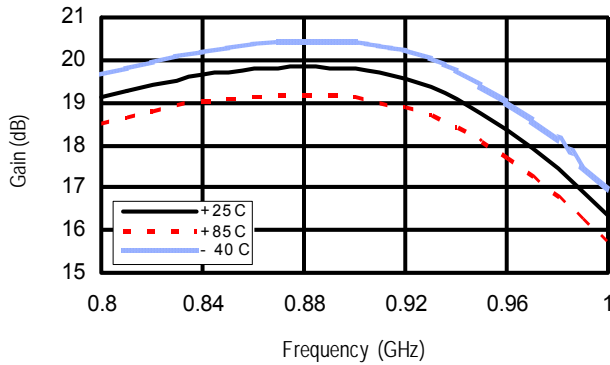

Gain vs Frequency (960 Band)

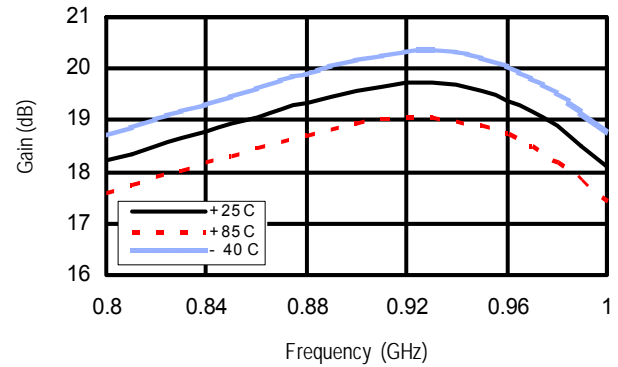

Input Return Loss vs Frequency
(860 & 915 Band)

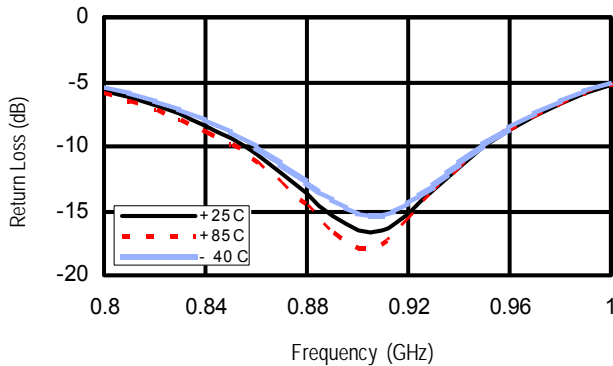

Input Return Loss vs Frequency
(960 Band)

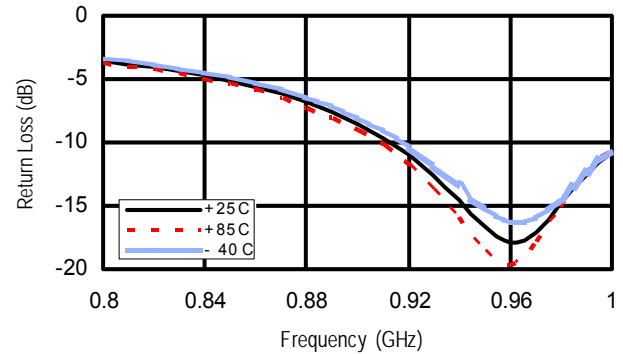

Output Return Loss vs Frequency
(860 & 915 Band)

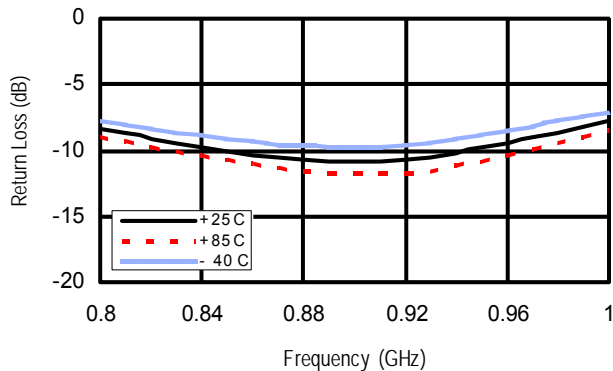

Output Return Loss vs Frequency
(960 Band)

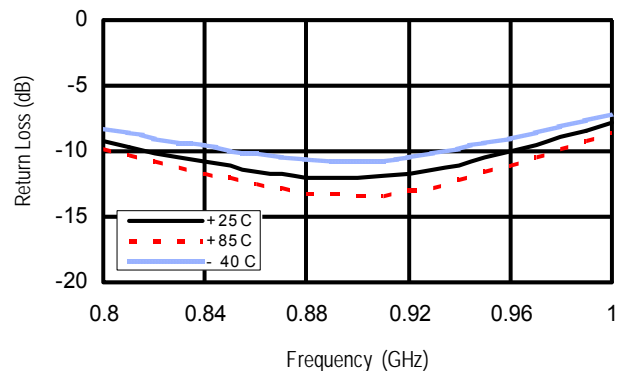

Typical Performance Curves at +25°C (Vcont = 4.4V @ 7 mA, VCC = 7.5V @ Icq = 540 mA)

Isolation vs Frequency (860 & 915 Band)

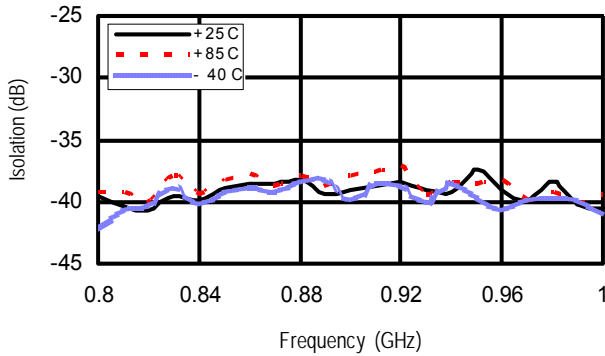

Isolation vs Frequency (960 Band)

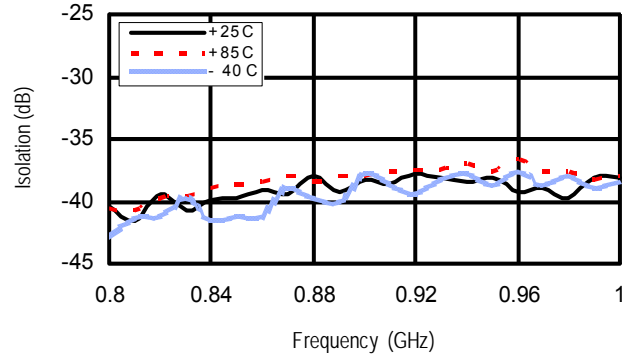

P-1dB vs Frequency (RFID Band)

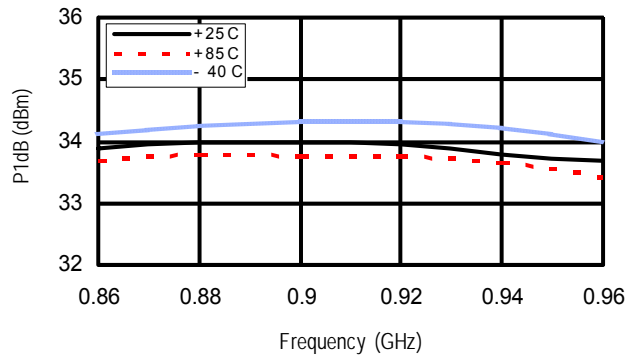

PAE vs Frequency @ P-1dB (RFID Band)

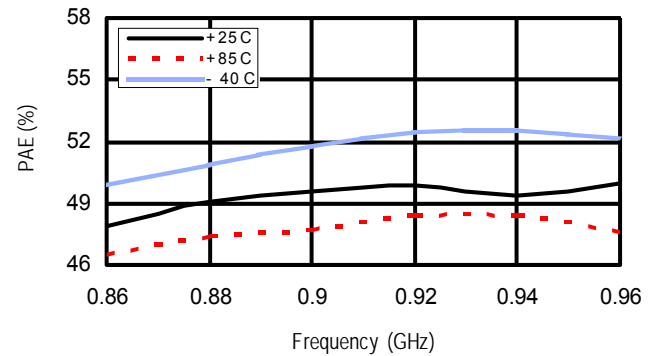

Two-Tone IM3 vs Pout

Freq = 915 MHz & 916 MHz

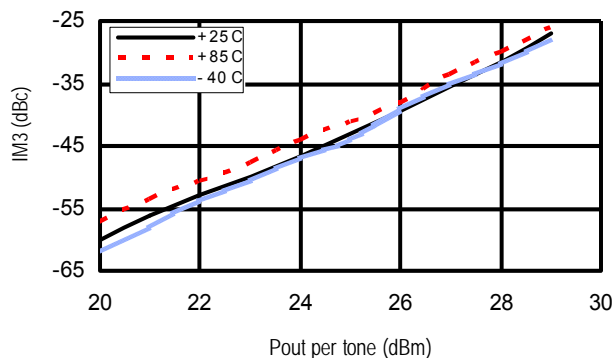

Two-Tone IM5 vs Pout

Freq = 915 MHz & 916 MHz

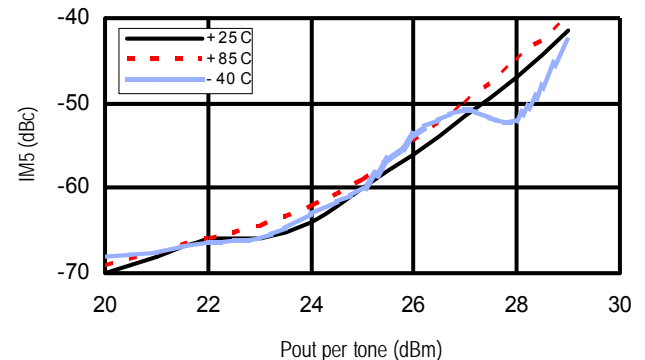

Ultra Linear 2W Power Amplifier 800 to 1000 MHz

Rev. V3

Application Circuit Schematic (Optimized for the 860 to 960 MHz RFID Band)

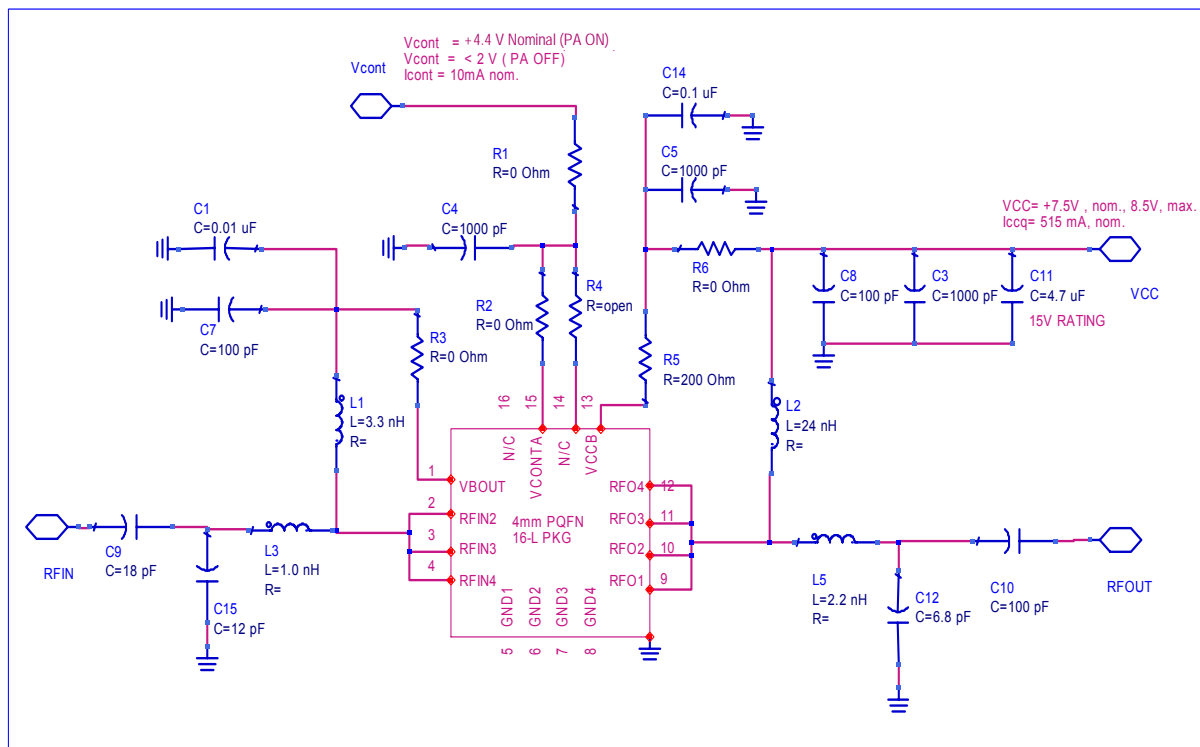

Evaluation Circuit Board Bill of Material

860 to 930 MHz RFID Band

960 MHz RFID Band

COMPONENT	PART NO.	PART NO.	VALUE	SUGGESTED VENDOR
PCB	1000028265	SAME		TYCO
R1	RK73Z1JTDD(0603)	SAME	000 ohm	KOA
R2,R3	RK73Z1ETTP(0402)	SAME	000 ohm	KOA
R5	RK73B1ETTP201J	SAME	200 ohm	KOA
R6	RK73Z1ETTP(0402)	SAME	000 ohm	KOA
C15	NPO0402HTTP120J	Location 30 mil left of that shown for 860 to 930 Band	12pF	KOA
C7,C8	NPO0402HTTP101J	SAME	100pF	KOA
C3,C4,C5	X7R0402HTTP102K	SAME	1000pF	KOA
C1	X7R0402CTTP103K	SAME	0.01uF	KOA
C10	NPO0603HTTD101J	SAME	100pF	KOA
C9	NPO0603HTTD180J	SAME	18pF	KOA
C14	X7R0402CTTP104K	SAME	0.1uF	KOA
C11	Y5V0805ATTE475M	SAME	4.7uF	KOA
C12	NPO0402HTTP6R8D	SAME	6.8pF	KOA
L3	0402CS-1N0XJL	Replace with 0 ohm jumper	1nH	COILCRAFT
L5	0402CS-2N2XJL	SAME	2.2nH	COILCRAFT
L1	0402CS-3N3XJLU	SAME	3.3nH	COILCRAFT
L2	0603CS-24NXJL	SAME	24nH	COILCRAFT
J1,J2	142-0711-881	SAME	RF CONN	JOHNSON
U1	MAAP-007649	MAAP-007649	4mmPQFN16L	TYCO
J3	TSM-105-01-S-DV	SAME	DC CONN	

EVALUATION CIRCUIT BOARD LAYOUT^{1,2,3,4} (Optimized for the 860 to 960 MHz RFID Band)

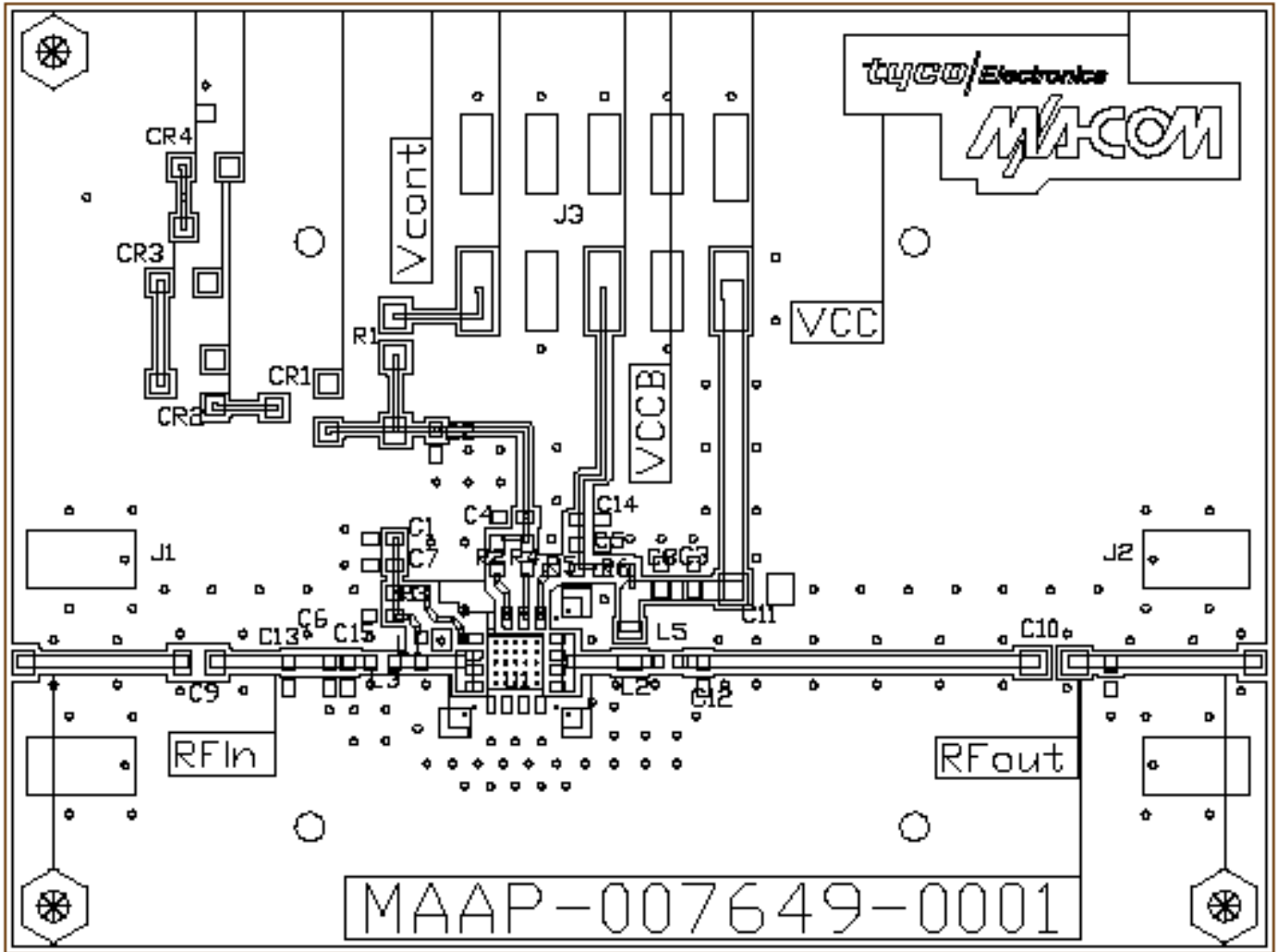

1. FR-408, 4-Layer, Coplanar 50 Ohm Line: $W = 19.0$ mils, $S = 10.0$ mils, $H = 10.0$ mils.
Total Board Thickness = 42.0 mils.
Board Size: 2.0 x 1.5 inches.
2. Via Geometry for the 4 mm PQFN package backside needs to provide a low-inductance ground and low thermal resistance path to the PCB back side ground.
Via Diameter: 8.0 mils finished size with 1.0 mils minimum plating.
At least 25 vias are required for thermal considerations. Additional top side metallization connected to ground vias is also recommended.
3. Heat sinking using a solid metal block below the PCB is recommended for optimum CW operation. Improper heat sinking below the PCB may degrade RF performance and / or reliability.
4. Evaluation circuit board assemblies use SnPb (tin lead) soldering process to attach all components, and are therefore not RoHS compliant.

Lead-Free 4 mm 16-Lead PQFN Package Outline Dimensions

